



# LAPAROSKOPIE

# LAPAROSCOPY





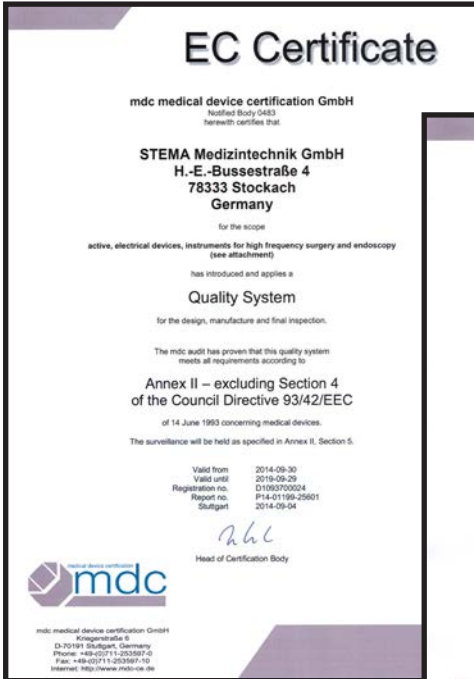

## Service/Zertifikate

Die STEMA Medizintechnik GmbH ist nach den höchsten Standards zertifiziert.

- DIN EN ISO 13485
- EG Richtlinien 93/42/EWG
- FDA

Diese Standards bilden eine essentielle Grundlage für unser Unternehmen und unsere Partner.

Sie symbolisieren ebenfalls das Engagement und Erstreben die Qualität unserer Produkte langfristig zu sichern.

## Service/Certificates

STEMA Medizintechnik GmbH is certified in accordance with the highest standards.

- DIN EN ISO 13485
- Council Directive 93/42/EEC
- FDA

These standards create an essential base for our company and our partners.

They also symbolize the commitment and strive to keep up the quality of our products.

## **P**rodukte

Das aktuelle Produktsortiment der STEMA Medizintechnik GmbH umfasst mehr als 10.000 verschiedene Artikel.

Wir decken folgende Segmente für die Chirurgie mit qualitativ hochwertigen Produkten ab:

- **Arthroskopie**
- **Bronchoskopie**
- **Container-Systeme**
- **Gastro-Intestinal**
- **Geräte**
- **Gynäkologie**
- **Herz-MIC**
- **HF-Chirurgie**
- **HNO**
- **Laminektomie**
- **Laparoskopie**
- **Mikromotoren-Systeme**
- **Proktoskopie**
- **Thorakoskopie**
- **Titan Platten Systeme**
- **Urologie**

Durch die enge Zusammenarbeit mit unseren Stamm-Lieferanten garantieren wir ein sehr hohes Qualitätsniveau.

Dies ist einer von vielen Gründen, die der Firma STEMA weltweit Kontakte zu verschiedenen Partner eröffnet, in unserem Namen sowie im OEM-Bereich.

## **P**roducts

*The current product range of STEMA Medizintechnik GmbH includes more than 10.000 different items.*

*We cover the following areas in surgery with high quality products:*

- **Arthroscopy**
- **Bronchoscopy**
- **Cardiac MIS**
- **Container-Systems**
- **ENT**
- **HF-Surgery**
- **Gastro-Intestinal**
- **Gynaecology**
- **Laminectomy**
- **Laparoscopy**
- **Micro motor systems**
- **Proctoscopy**
- **Thoracoscopy**
- **Titanium plating system**
- **Units**
- **Urology**

*A close cooperation with our suppliers guarantees a very high quality level.*

*This is one of many reasons which open STEMA contacts to various partners all over the world, in our name as well as on OEM base.*

## ENDOSKOPE / ENDOSCOPES

## SEITE / PAGE

Laparoskope / <i>Laparoscopes</i> .....	8
HD Laparoskope / <i>HD laparoscopes</i> .....	9
OP Laparoskope / <i>OR laparoscopes</i> .....	10

## INSUFFLATION / INSUFFLATION

Verres Nadeln / <i>Verres needles</i> .....	11
---	----

## TROKARSYSTEME / TROCAR SYSTEM

Hasson Trokarsysteme / <i>Hasson trocar systems</i> .....	12
Automatik-Trokar-Sets mit Gewindeverschluss / <i>Automatic trocar sets with winded locking</i> .....	13-18
Automatik-Trokar-Sets mit Silikondichtungen / <i>Automatic trocar sets with silicone valves</i> .....	19-22
Metallschaftrohre / <i>Metal tubes</i> .....	23
Kunststoffschaftrohre / <i>Plastic tubes</i> .....	24
Ersatzteile: Dichtkappen, Innendichtungen / <i>Spare parts: sealing caps, inner seals</i> .....	25
Große Automatik-Trokar-Sets mit Gewindeverschluss / <i>Large automatic trocar sets with winded locking</i> .....	26
Ersatzteile: Dichtkappen, Innendichtungen / <i>Spare parts: sealing caps, inner seals</i> .....	27
Bariatric Automatik-Trokar-Sets mit Gewindeverschluss / <i>Bariatric automatic trocar sets with winded locking</i> .....	28, 31
Bariatric Automatik-Trokar-Sets mit Silikondichtungen / <i>Bariatric automatic trocar sets with silicone valves</i> .....	29, 32
Metallschaftrohre / <i>Metal tubes</i> .....	30, 33
Ersatzteile: Dichtkappen, Innendichtungen / <i>Spare parts: sealing caps, inner seals</i> .....	30, 33
Trokarstops / <i>Trocarstops</i> .....	34
Bauchdeckenspekulum / <i>Abdominal speculum</i> .....	34
Standardtrokare / <i>Standard trocars</i> .....	35-36
Sicherheitstrocare / <i>Safety trocars</i> .....	37-38
Dilatation Ballon System / <i>Dilatation balloon system</i> .....	38
Reduzierer / <i>Reducers</i> .....	39

## VERSCHIEDENES / VARIOUS

Applikator / <i>Applicator</i> .....	40
Injektionskanülen / <i>Injection needles</i> .....	40
Taststäbe / <i>Palpation probes</i> .....	40
Dilatationssätze / <i>Dilation sets</i> .....	40

## SAUG- UND SPÜLSYSTEME / SUCTION AND IRRIGATION SYSTEMS

Rundlochsauger / <i>Roundhole suckers</i> .....	41
Zerlegbare Saug- und Spülsysteme / <i>Detachable suction and irrigation systems</i> .....	42-48
Kombinationen mit monopolarer Koagulation / <i>Combinations with monopolar coagulation</i> .....	49-50, 52

## MONOPOLARE KOAGULATION / MONOPOLAR COAGULATION

Standard Elektroden / <i>Standard electrodes</i> .....	51
Elektroden mit auswechselbaren Spitzen / <i>Electrodes with exchangeable tips</i> .....	53
Elektroden mit Keramikspitzen / <i>Electrodes with ceramic tips</i> .....	54

## MODULARES SYSTEM / MODULAR SYSTEM

Schäfte / <i>Sheaths</i> .....	55
Handgriffe / <i>Handles</i> .....	56-58
Ø 5mm Kombinationen / <i>Ø 5mm combinations</i> .....	59-67
Ø 10mm Kombinationen / <i>Ø 10mm combinations</i> .....	68-71

## NICHT ZERLEGBARE INSTRUMENTE / NON DETACHABLE INSTRUMENTS

Ø 10mm Faßzangen / <i>Ø 10mm grasping forceps</i> .....	72
Ø 5mm Faßzangen mit Federgriff / <i>Ø 5mm grasping forceps with U-spring handle</i> .....	73

## NAHT / SUTURE

Nadelhalter / <i>Needle holders</i> .....	74-77
Nähhilfen / <i>Suture aid</i> .....	78-79

**CLIP APPLIKATION / CLIP APPLICATION**

**SEITE / PAGE**

Nicht zerlegbare Clipanlagezangen / <i>Non detachable clip applying forceps</i> .....	80
Zerlegbare Clipanlagezangen / <i>Detachable clip applying forceps</i> .....	81-83
Titan Clips / <i>Titanium clips</i> .....	84

**RETRAKTOREN / RETRACTORS**

Starre Endoretraktoren / <i>Rigid endo retractors</i> .....	85
Abwinkel- und verstellbare Retraktoren / <i>Articulating and adjustable retractors</i> .....	85-87

**SPEZIAL / SPECIAL**

Cholangiographiezange / <i>Cholangiography forceps</i> .....	87
--	----

**BIPOLARE INSTRUMENTE / BIPOLAR INSTRUMENTS**

Standardelektroden / <i>Standard electrodes</i> .....	88
Zerlegbare Instrumente / <i>Detachable instruments</i> .....	89-95

**ANSCHLUSSKABEL / CONNECTING CABLES**

Monopolare Anschlusskabel / <i>Monopolar connecting cables</i> .....	96
Bipolare Anschlusskabel / <i>Bipolar connecting cables</i> .....	97-99

**ENDOSKOPHALTER / ENDOSCOPE HOLDER**

Flexible Systeme / <i>Flexible systems</i> .....	100, 102
Doppel-Halteam-System / <i>Double stem holding system</i> .....	101

**REINIGUNG / CLEANING**

Reinigungspistole / <i>Cleaning pistol</i> .....	129
Reinigungsbürsten / <i>Cleaning brushes</i> .....	129
Spezialfett / <i>Special grease</i> .....	129

**LAGERUNG / STORAGE**

Lagerungsrack für Laparoskopieinstrumente / <i>Storage rack for laparoscopic instruments</i> .....	130
--	-----

**STERILISATION / STERILIZATION**

Siebkörbe für Endoskope / <i>Wire baskets for endoscopes</i> .....	131
Endoskop Container / <i>Endoscope container</i> .....	131

## **PÄDIATRIE / PEDIATRY**

### **ENDOSKOPE / ENDOSCOPES**

**SEITE / PAGE**

Laparoskope / Laparoscopes ..... 103

### **TROKARSYSTEME / TROCAR SYSTEM**

Automatik-Trokar-Sets mit Gewindeverschluss / Automatic trocar sets with winded locking ..... 104  
 Standard Trokar-Sets / Standard trocar sets ..... 104  
 Ersatzteile: Dichtkappen, Innendichtungen / Spare parts: sealing caps, inner seals ..... 25  
 Standardtrokare / Standard trocars ..... 105  
 Sicherheitstrocars / Safety trocars ..... 105

### **VERSCHIEDENES / VARIOUS**

Injektionskanülen / Injection needles ..... 106

### **SAUG- UND SPÜLSYSTEME / SUCTION AND IRRIGATION SYSTEMS**

Rundlochsauger / Roundhole suckers ..... 106  
 Zerlegbare Saug- und Spülsysteme / Detachable suction and irrigation systems ..... 106

### **MONOPOLARE KOAGULATION / MONOPOLAR COAGULATION**

Standard Elektroden / Standard electrodes ..... 107

### **NAHT / SUTURE**

Nadelhalter / Needle holders ..... 108  
 Nähhilfen / Suture aid ..... 79

### **NICHT ZERLEGBARE INSTRUMENTE / NON DETACHABLE INSTRUMENTS**

Ø 2mm Instrumente / Ø 2mm instruments ..... 109

### **MODULARES SYSTEM / MODULAR SYSTEM**

Schäfte / Sheaths ..... 110  
 Handgriffe / Handles ..... 111-113  
 Ø 3mm Kombinationen / Ø 3mm combinations ..... 123-125  
 Ø 5mm Kombinationen / Ø 5mm combinations ..... 114-122

### **BIPOLARE INSTRUMENTE / BIPOLAR INSTRUMENTS**

Standardelektroden / Standard electrodes ..... 88  
 Zerlegbare Instrumente / Detachable instruments ..... 126-128

### **REINIGUNG / CLEANING**

Reinigungspistole / Cleaning pistol ..... 129  
 Reinigungsbürsten / Cleaning brushes ..... 129  
 Spezialfett / Special grease ..... 129

### **STERILISATION / STERILIZATION**

Siebkörbe für Endoskope / Wire baskets for endoscopes ..... 130  
 Endoskop Container / Endoscope container ..... 130





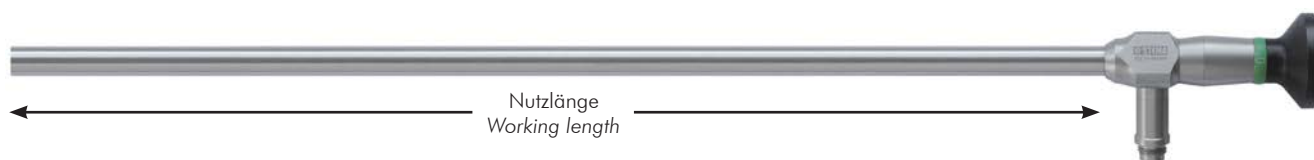

Bestell-Nr. Ordering no.	Durchmesser Diameter	Blickrichtung Direction of view	Nutzlänge Working length
EA-001-001	2.9mm	0°	302mm
EA-001-002	2.9mm	30°	302mm
EA-002-001	5.0mm	0°	302mm
EA-002-002	5.0mm	30°	302mm
EA-002-003	5.0mm	70°	302mm
EA-002-004	5.0mm	0°	334mm
EA-002-005	5.0mm	30°	334mm
EA-005-001	6.5mm	0°	334mm
EA-005-002	6.5mm	30°	334mm
EA-003-001	10.0mm	0°	316mm
EA-003-002	10.0mm	30°	317mm
EA-003-005	10.0mm	0°	349mm
EA-003-006	10.0mm	30°	350mm
EA-003-003	10.0mm	0°	500mm (Bariatric)
EA-003-004	10.0mm	30°	500mm (Bariatric)
EA-003-007	10.0mm	45°	449mm (Bariatric)
EA-003-008	10.0mm	45°	300mm

**STEMA** **High Definition**

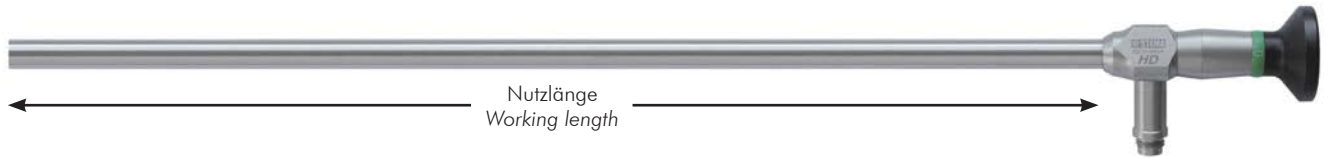

Bestell-Nr. Ordering no.	Durchmesser Diameter	Blickrichtung Direction of view	Nutzlänge Working length
EA-001-011	2.9mm	0°	302mm
EA-001-012	2.9mm	30°	302mm
EA-002-011	5.0mm	0°	302mm
EA-002-012	5.0mm	30°	302mm
EA-002-013	5.0mm	70°	302mm
EA-002-014	5.0mm	0°	334mm
EA-002-015	5.0mm	30°	334mm
EA-005-011	6.5mm	0°	334mm
EA-005-012	6.5mm	30°	334mm
EA-003-011	10.0mm	0°	316mm
EA-003-012	10.0mm	30°	317mm
EA-003-015	10.0mm	0°	349mm
EA-003-016	10.0mm	30°	350mm

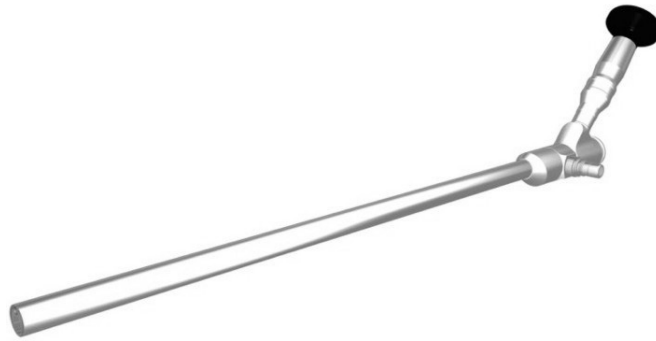

Bestell-Nr. Ordering no.	Durchmesser Diameter	Abwinkelung Proximal end	Arbeitskanal Ø Working channel Ø	Blickrichtung Direction of view	Nutzlänge Working length
EA-004-001	10.0mm	45°	6mm	0°	270mm
EA-004-003	10.0mm	45°	6mm	0°	190mm

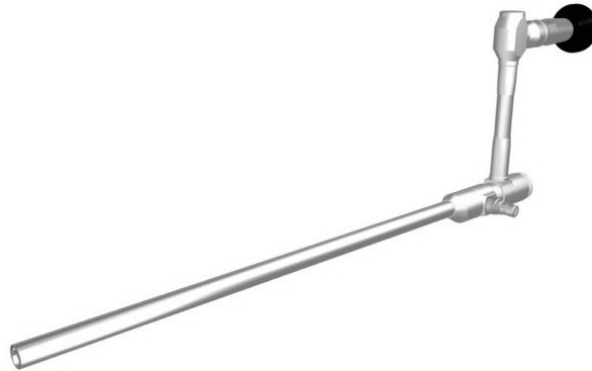

Bestell-Nr. Ordering no.	Durchmesser Diameter	Abwinkelung Proximal end	Arbeitskanal Ø Working channel Ø	Blickrichtung Direction of view	Nutzlänge Working length
EA-004-002	10.0mm	90°	6mm	0°	270mm
EA-004-004	10.0mm	90°	6mm	0°	190mm



**Bestell-Nr.**  
**Ordering no.**

<b>EH-033-001</b>	Verres Nadel, Ø 2mm, Arbeitslänge <b>55mm</b> Verres needle, Ø 2mm, working length <b>55mm</b>
<b>EH-033-002</b>	Verres Nadel, Ø 2mm, Arbeitslänge <b>70mm</b> Verres needle, Ø 2mm, working length <b>70mm</b>
<b>EH-033-003</b>	Verres Nadel, Ø 2mm, Arbeitslänge <b>80mm</b> Verres needle, Ø 2mm, working length <b>80mm</b>
<b>EH-033-004</b>	Verres Nadel, Ø 2mm, Arbeitslänge <b>100mm</b> Verres needle, Ø 2mm, working length <b>100mm</b>
<b>EH-033-005</b>	Verres Nadel, Ø 2mm, Arbeitslänge <b>120mm</b> Verres needle, Ø 2mm, working length <b>120mm</b>
<b>EH-033-006</b>	Verres Nadel, Ø 2mm, Arbeitslänge <b>130mm</b> Verres needle, Ø 2mm, working length <b>130mm</b>
<b>EH-033-007</b>	Verres Nadel, Ø 2mm, Arbeitslänge <b>140mm</b> Verres needle, Ø 2mm, working length <b>140mm</b>
<b>EH-033-008</b>	Verres Nadel, Ø 2mm, Arbeitslänge <b>150mm</b> Verres needle, Ø 2mm, working length <b>150mm</b>
<b>EH-033-009</b>	Verres Nadel, Ø 2mm, Arbeitslänge <b>170mm</b> Verres needle, Ø 2mm, working length <b>170mm</b>
<b>EH-033-010</b>	Verres Nadel, Ø 2mm, Arbeitslänge <b>180mm</b> Verres needle, Ø 2mm, working length <b>180mm</b>
<b>EH-033-011</b>	Verres Nadel, Ø 2mm, Arbeitslänge <b>200mm</b> Verres needle, Ø 2mm, working length <b>200mm</b>
<b>EH-033-012</b>	Verres Nadel, Ø 2mm, Arbeitslänge <b>230mm</b> Verres needle, Ø 2mm, working length <b>230mm</b>



**Bestell-Nr.**  
**Ordering no.**

<b>EH-033-024</b>	High-Flow Verres Nadel Ø 2.7mm, Arbeitslänge <b>100mm</b> High-Flow Verres needle Ø 2,7mm, working length <b>100mm</b>
<b>EH-033-025</b>	High-Flow Verres Nadel Ø 2.7mm, Arbeitslänge <b>120mm</b> High-Flow Verres needle Ø 2,7mm, working length <b>120mm</b>
<b>EH-033-028</b>	High-Flow Verres Nadel Ø 2.7mm, Arbeitslänge <b>150mm</b> High-Flow Verres needle Ø 2,7mm, working length <b>150mm</b>
<b>EH-033-029</b>	High-Flow Verres Nadel Ø 2.7mm, Arbeitslänge <b>170mm</b> High-Flow Verres needle Ø 2,7mm, working length <b>170mm</b>

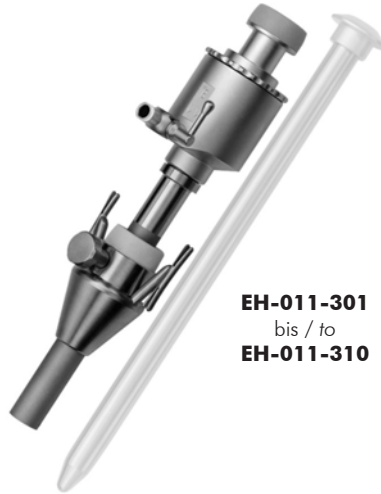

**EH-011-301**  
bis / to  
**EH-011-310**

	Ømm	Hülse mit Trokar Sleeves with trocar	Hülse mit Schaftrohr Sleeve with tube
HASSON Automatik Trokarhülse, Metallschaftrohr	<b>3.5</b>	<b>EH-011-301</b>	<b>EH-011-001</b>
glatt, Fadenhalter am Konus	<b>5.5</b>	<b>EH-011-303</b>	<b>EH-011-003</b>
HASSON Automatic trocar sleeve, metal tube	<b>11.0</b>	<b>EH-011-309</b>	<b>EH-011-009</b>
smooth, suture holder at cone	<b>12.5</b>	<b>EH-011-310</b>	<b>EH-011-010</b>



**EJ-012-001**  
bis / to  
**EJ-012-011**



**EJ-013-010**

	Ømm	Hülse mit Trokar Sleeves with trocar
HASSON Konus fixierbar mit Fadenhalter HASSON cone adjustable with suture holder	<b>3.5</b>	<b>EJ-012-001</b>
	<b>5.5</b>	<b>EJ-012-003</b>
	<b>10.0</b>	<b>EJ-012-008</b>
	<b>11.0</b>	<b>EJ-012-009</b>
	<b>12.5</b>	<b>EJ-012-010</b>
HASSON Konus mit Gewinde / Fixierung ist nicht notwendig HASSON cone threaded / fixation is not necessary	<b>13.0</b>	<b>EJ-012-011</b>
	<b>11.0</b>	<b>EJ-013-010</b>



**EH-009-101**  
bis / to  
**EH-009-111**





**EH-009-201**  
bis / to  
**EH-009-211**



**EH-028-103**  
bis / to  
**EH-028-110**



**EH-028-203**  
bis / to  
**EH-028-210**

	Ømm	Set inkl. Trokar Set incl. trocar	Hülse mit Schaftrohr Sleeve with tube	
<p>Automatik Trokarhülse mit manueller Klappenöffnung, Metallschaftrohr glatt, Gehäuse mit Gewindeverschluss, mit <b>konischem Trokar</b></p> <p><i>Automatic trocar sleeve with seperate opening lever, metal tube smooth, housing with winded locking, with <b>conical trocar</b></i></p>	3.5	EH-009-101	EH-009-001	
	5.0	EH-009-102	EH-009-002	
	5.5	EH-009-103	EH-009-003	
	7.0	EH-009-106	EH-009-006	
	8.0	EH-009-107	EH-009-007	
	10.0	EH-009-108	EH-009-008	
	11.0	EH-009-109	EH-009-009	
	12.5	EH-009-110	EH-009-010	
	13.0	EH-009-111	EH-009-011	
	<p>Automatik Trokarhülse mit manueller Klappenöffnung, Metallschaftrohr glatt, Gehäuse mit Gewindeverschluss, mit <b>dreikant Trokar</b></p> <p><i>Automatic trocar sleeve with seperate opening lever, metal tube smooth, housing with winded locking, with <b>pyramidal trocar</b></i></p>	3.5	EH-009-201	
5.0		EH-009-202	EH-009-002	
5.5		EH-009-203	EH-009-003	
7.0		EH-009-206	EH-009-006	
8.0		EH-009-207	EH-009-007	
10.0		EH-009-208	EH-009-008	
11.0		EH-009-209	EH-009-009	
12.5		EH-009-210	EH-009-010	
13.0		EH-009-211	EH-009-011	
<p>Automatik Trokarhülse mit manueller Klappenöffnung, Gewindemetallschaftrohr, Gehäuse mit Gewindeverschluss, mit <b>konischem Trokar</b></p> <p><i>Automatic trocar sleeve with seperate opening lever, threaded metal tube, housing with winded locking, with <b>conical trocar</b></i></p>		5.5	EH-028-103	EH-028-003
	11.0	EH-028-109	EH-028-009	
	12.5	EH-028-110	EH-028-010	
<p>Automatik Trokarhülse mit manueller Klappenöffnung, Gewindemetallschaftrohr, Gehäuse mit Gewindeverschluss, mit <b>dreikant Trokar</b></p> <p><i>Automatic trocar sleeve with seperate opening lever, threaded metal tube, housing with winded locking, with <b>pyramidal trocar</b></i></p>	5.5	EH-028-203	EH-028-003	
	11.0	EH-028-209	EH-028-009	
	12.5	EH-028-210	EH-028-010	



**EH-005-101**  
 bis / to  
**EH-005-111**



**EH-005-201**  
 bis / to  
**EH-005-211**



**EH-006-103**  
 bis / to  
**EH-006-110**



**EH-006-203**  
 bis / to  
**EH-006-210**

	Ømm	Set inkl. Trokar Set incl. trocar	Hülse mit Schaftrohr Sleeve with tube			
Automatik Trokarhülse, Metallschaftrohr glatt, Gehäuse mit Gewindeverschluss, mit <b>konischem Trokar</b>  Automatic trocar sleeve, metal tube smooth, housing with winded locking, with <b>conical trocar</b>	3.5	<b>EH-005-101</b>	<b>EH-005-001</b>			
	5.0	<b>EH-005-102</b>	<b>EH-005-002</b>			
	5.5	<b>EH-005-103</b>	<b>EH-005-003</b>			
	7.0	<b>EH-005-106</b>	<b>EH-005-006</b>			
	8.0	<b>EH-005-107</b>	<b>EH-005-007</b>			
	10.0	<b>EH-005-108</b>	<b>EH-005-008</b>			
	11.0	<b>EH-005-109</b>	<b>EH-005-009</b>			
	12.5	<b>EH-005-110</b>	<b>EH-005-010</b>			
	Automatik Trokarhülse, Metallschaftrohr glatt, Gehäuse mit Gewindeverschluss, mit <b>dreikant Trokar</b>  Automatic trocar sleeve, metal tube smooth, housing with winded locking, with <b>pyramidal trocar</b>	3.5	<b>EH-005-201</b>		<b>EH-005-001</b>	
		5.0	<b>EH-005-202</b>		<b>EH-005-002</b>	
5.5		<b>EH-005-203</b>	<b>EH-005-003</b>			
7.0		<b>EH-005-206</b>	<b>EH-005-006</b>			
8.0		<b>EH-005-207</b>	<b>EH-005-007</b>			
10.0		<b>EH-005-208</b>	<b>EH-005-008</b>			
11.0		<b>EH-005-209</b>	<b>EH-005-009</b>			
12.5		<b>EH-005-210</b>	<b>EH-005-010</b>			
Automatik Trokarhülse, Gewindemetallschaftrohr, Gehäuse mit Gewindeverschluss, mit <b>konischem Trokar</b>  Automatic trocar sleeve, threaded metal tube, housing with winded locking, with <b>conical trocar</b>	5.5	<b>EH-006-103</b>	<b>EH-006-003</b>			
	11.0	<b>EH-006-109</b>	<b>EH-006-009</b>			
	12.5	<b>EH-006-110</b>	<b>EH-006-010</b>			
Automatik Trokarhülse, Gewindemetallschaftrohr, Gehäuse mit Gewindeverschluss, mit <b>dreikant Trokar</b>  Automatic trocar sleeve, threaded metal tube, housing with winded locking, with <b>pyramidal trocar</b>	5.5	<b>EH-006-203</b>	<b>EH-006-003</b>			
	11.0	<b>EH-006-209</b>	<b>EH-006-009</b>			
	12.5	<b>EH-006-210</b>	<b>EH-006-010</b>			



**EH-109-101**  
bis / to  
**EH-109-111**



**EH-109-201**  
bis / to  
**EH-109-211**



**EH-128-103**  
bis / to  
**EH-128-111**



**EH-128-203**  
bis / to  
**EH-128-211**

	Ømm	Set inkl. Trokar Set incl. trocar	Hülse mit Schaftrohr Sleeve with tube	Farbe Colour	
<p>Automatik Trokarhülse mit manueller Klappenöffnung, Metallschaftrohr glatt, Gehäuse mit Gewindeverschluss, mit <b>konischem Trokar</b></p> <p><i>Automatic trocar sleeve with separate opening lever, metal tube smooth, housing with winded locking, with <b>conical trocar</b></i></p>	3.5	<b>EH-109-101</b>	<b>EH-109-001</b>		
	5.5	<b>EH-109-103</b>	<b>EH-109-003</b>	<b>Weiß/White</b>	
	11.0	<b>EH-109-109</b>	<b>EH-109-009</b>	<b>Blau/Blue</b>	
	13.0	<b>EH-109-111</b>	<b>EH-109-011</b>	<b>Grün/Green</b>	
<p>Automatik Trokarhülse mit manueller Klappenöffnung, Metallschaftrohr glatt, Gehäuse mit Gewindeverschluss, mit <b>dreikant Trokar</b></p> <p><i>Automatic trocar sleeve with separate opening lever, metal tube smooth, housing with winded locking, with <b>pyramidal trocar</b></i></p>	3.5	<b>EH-109-201</b>	<b>EH-109-001</b>		
	5.5	<b>EH-109-203</b>	<b>EH-109-003</b>	<b>Weiß/White</b>	
	11.0	<b>EH-109-209</b>	<b>EH-109-009</b>	<b>Blau/Blue</b>	
	13.0	<b>EH-109-211</b>	<b>EH-109-011</b>	<b>Grün/Green</b>	
<p>Automatik Trokarhülse mit manueller Klappenöffnung, Gewindemetallschaftrohr, Gehäuse mit Gewindeverschluss, mit <b>konischem Trokar</b></p> <p><i>Automatic trocar sleeve with separate opening lever, threaded metal tube, housing with winded locking, with <b>conical trocar</b></i></p>	5.5	<b>EH-128-103</b>	<b>EH-128-003</b>	<b>Weiß/White</b>	
	11.0	<b>EH-128-109</b>	<b>EH-128-009</b>	<b>Blau/Blue</b>	
	13.0	<b>EH-128-111</b>	<b>EH-128-011</b>	<b>Grün/Green</b>	
<p>Automatik Trokarhülse mit manueller Klappenöffnung, Gewindemetallschaftrohr, Gehäuse mit Gewindeverschluss, mit <b>dreikant Trokar</b></p> <p><i>Automatic trocar sleeve with separate opening lever, threaded metal tube, housing with winded locking, with <b>pyramidal trocar</b></i></p>	5.5	<b>EH-128-203</b>	<b>EH-128-003</b>	<b>Weiß/White</b>	
	11.0	<b>EH-128-209</b>	<b>EH-128-009</b>	<b>Blau/Blue</b>	
	13.0	<b>EH-128-211</b>	<b>EH-128-011</b>	<b>Grün/Green</b>	





**EH-029-103**  
 bis / to  
**EH-029-110**



**EH-029-203**  
 bis / to  
**EH-029-210**



**EH-029-403**  
 bis / to  
**EH-029-410**



**EH-029-503**  
 bis / to  
**EH-029-510**

	Ømm	Set inkl. Trokar Set incl. trocar	Hülse mit Schaftrohr Sleeve with tube	
Automatik Trokarhülse mit manueller Klappenöffnung, Kunststoffschaftrohr glatt, Gehäuse mit Gewindeverschluss, mit <b>konischem Trokar</b>  Automatic trocar sleeve with separate opening lever, plastic tube smooth, housing with winded locking, with <b>conical trocar</b>	5.5	<b>EH-029-103</b>	<b>EH-029-003</b>	
	11.0	<b>EH-029-109</b>	<b>EH-029-009</b>	
	12.5	<b>EH-029-110</b>	<b>EH-029-010</b>	
Automatik Trokarhülse mit manueller Klappenöffnung, Kunststoffschaftrohr glatt, Gehäuse mit Gewindeverschluss, mit <b>dreikant Trokar</b>  Automatic trocar with separate opening lever, plastic tube smooth, housing with winded locking, with <b>pyramidal trocar</b>	5.5	<b>EH-029-203</b>	<b>EH-029-003</b>	
	11.0	<b>EH-029-209</b>	<b>EH-029-009</b>	
	12.5	<b>EH-029-210</b>	<b>EH-029-010</b>	
Automatik Trokarhülse mit manueller Klappenöffnung, Gewindekunststoffschaftrohr, Gehäuse mit Gewindeverschluss, mit <b>konischem Trokar</b>  Automatic trocar sleeve with separate opening lever, threaded plastic tube, housing with winded locking, with <b>conical trocar</b>	5.5	<b>EH-029-403</b>	<b>EH-029-303</b>	
	11.0	<b>EH-029-409</b>	<b>EH-029-309</b>	
	12.5	<b>EH-029-410</b>	<b>EH-029-310</b>	
Automatik Trokarhülse mit manueller Klappenöffnung, Gewindekunststoffschaftrohr, Gehäuse mit Gewindeverschluss, mit <b>dreikant Trokar</b>  Automatic trocar sleeve with separate opening lever, threaded plastic tube, housing with winded locking, with <b>pyramidal trocar</b>	5.5	<b>EH-029-503</b>	<b>EH-029-303</b>	
	11.0	<b>EH-029-509</b>	<b>EH-029-309</b>	
	12.5	<b>EH-029-510</b>	<b>EH-029-310</b>	



**EH-007-103**  
bis / to  
**EH-007-110**







**EH-007-203**  
bis / to  
**EH-007-210**



**EH-008-103**  
bis / to  
**EH-008-110**



**EH-008-203**  
bis / to  
**EH-008-210**

	Ømm	Set inkl. Trokar Set incl. trocar	Hülse mit Schaftrohr Sleeve with tube	
Automatik Trokarhülse, Kunststoffschaftrohr glatt, Gehäuse mit Gewindeverschluss, mit <b>konischem Trokar</b>  <i>Automatic trocar sleeve, plastic tube smooth,            housing with winded locking, with  <b>conical trocar</b></i>	5.5	<b>EH-007-103</b>	<b>EH-007-003</b>	
	11.0	<b>EH-007-109</b>	<b>EH-007-009</b>	
	12.5	<b>EH-007-110</b>	<b>EH-007-010</b>	
Automatik Trokarhülse, Kunststoffschaftrohr glatt, Gehäuse mit Gewindeverschluss, mit <b>dreikant Trokar</b>  <i>Automatic trocar sleeve, plastic tube smooth,            housing with winded locking, with  <b>pyramidal trocar</b></i>	5.5	<b>EH-007-203</b>	<b>EH-007-003</b>	
	11.0	<b>EH-007-209</b>	<b>EH-007-009</b>	
	12.5	<b>EH-007-210</b>	<b>EH-007-010</b>	
Automatik Trokarhülse, Gewindekunststoffschaftrohr, Gehäuse mit Gewindeverschluss, mit <b>konischem Trokar</b>  <i>Automatic trocar sleeve, threaded plastic tube,            housing with winded locking, with  <b>conical trocar</b></i>	5.5	<b>EH-008-103</b>	<b>EH-008-003</b>	
	11.0	<b>EH-008-109</b>	<b>EH-008-009</b>	
	12.5	<b>EH-008-110</b>	<b>EH-008-010</b>	
Automatik Trokarhülse, Gewindekunststoffschaftrohr, Gehäuse mit Gewindeverschluss, mit <b>dreikant Trokar</b>  <i>Automatic trocar sleeve, threaded plastic tube,            housing with winded locking, with  <b>pyramidal trocar</b></i>	5.5	<b>EH-008-203</b>	<b>EH-008-003</b>	
	11.0	<b>EH-008-209</b>	<b>EH-008-009</b>	
	12.5	<b>EH-008-210</b>	<b>EH-008-010</b>	



**EH-129-103**  
bis / to  
**EH-129-110**



**EH-129-203**  
bis / to  
**EH-129-210**



**EH-129-403**  
bis / to  
**EH-129-410**



**EH-129-503**  
bis / to  
**EH-129-510**

	Ømm	Set inkl. Trokar Set incl. trocar	Hülse mit Schaffrohr Sleeve with tube	Farbe Colour	
Automatik Trokarhülse mit manueller Klappenöffnung, Kunststoffschaffrohr glatt, Gehäuse mit Gewindeverschluss, mit <b>konischem Trokar</b>  Automatic trocar sleeve with separate opening lever, plastic tube smooth, housing with winded locking, with <b>conical trocar</b>	5.5	<b>EH-129-103</b>	<b>EH-129-003</b>	<b>Weiß/White</b>	
	11.0	<b>EH-129-109</b>	<b>EH-129-009</b>	<b>Blau/Blue</b>	
	13.0	<b>EH-129-111</b>	<b>EH-129-011</b>	<b>Grün/Green</b>	
Automatik Trokarhülse mit manueller Klappenöffnung, Kunststoffschaffrohr glatt, Gehäuse mit Gewindeverschluss, mit <b>dreikant Trokar</b>  Automatic trocar sleeve with separate opening lever, plastic tube smooth, housing with winded locking, with <b>pyramidal trocar</b>	5.5	<b>EH-129-203</b>	<b>EH-129-003</b>	<b>Weiß/White</b>	
	11.0	<b>EH-129-209</b>	<b>EH-129-009</b>	<b>Blau/Blue</b>	
	13.0	<b>EH-129-211</b>	<b>EH-129-011</b>	<b>Grün/Green</b>	
Automatik Trokarhülse mit manueller Klappenöffnung, Gewindekunststoffschaffrohr, Gehäuse mit Gewindeverschluss, mit <b>konischem Trokar</b>  Automatic trocar sleeve with separate opening lever, threaded plastic tube, housing with winded locking, with <b>conical trocar</b>	5.5	<b>EH-129-403</b>	<b>EH-129-303</b>	<b>Weiß/White</b>	
	11.0	<b>EH-129-409</b>	<b>EH-129-309</b>	<b>Blau/Blue</b>	
	13.0	<b>EH-129-411</b>	<b>EH-129-311</b>	<b>Grün/Green</b>	
Automatik Trokarhülse mit manueller Klappenöffnung, Gewindekunststoffschaffrohr, Gehäuse mit Gewindeverschluss, mit <b>dreikant Trokar</b>  Automatic trocar sleeve with separate opening lever, threaded plastic tube, housing with winded locking, with <b>pyramidal trocar</b>	5.5	<b>EH-129-503</b>	<b>EH-129-303</b>	<b>Weiß/White</b>	
	11.0	<b>EH-129-509</b>	<b>EH-129-309</b>	<b>Blau/Blue</b>	
	13.0	<b>EH-129-511</b>	<b>EH-129-311</b>	<b>Grün/Green</b>	



**EH-014-101**  
bis / to  
**EH-014-110**







**EH-014-201**  
bis / to  
**EH-014-210**



**EH-015-103**  
bis / to  
**EH-015-110**



**EH-015-203**  
bis / to  
**EH-015-210**

	Ømm	Set inkl. Trokar Set incl. trocar	Hülse mit Schaftrohr Sleeve with tube	
Automatik Trokarhülse mit Silikonventil, Metallschaftrohr glatt, mit <b>konischem Trokar</b>  <i>Automatic trocar sleeve with silicone valve, metall tube smooth, with <b>conical trocar</b></i>	3.5	EH-014-101	EH-014-001	
	5.5	EH-014-103	EH-014-003	
	7.0	EH-014-106	EH-014-006	
	8.0	EH-014-107	EH-014-007	
	10.0	EH-014-108	EH-014-008	
	11.0	EH-014-109	EH-014-009	
	12.5	EH-014-110	EH-014-010	
Automatik Trokarhülse mit Silikonventil, Metallschaftrohr glatt, mit <b>dreikant Trokar</b>  <i>Automatic trocar sleeve with silicone valve, metall tube smooth, with <b>pyramidal trocar</b></i>	3.5	EH-014-201	EH-014-001	
	5.5	EH-014-203	EH-014-003	
	7.0	EH-014-206	EH-014-006	
	8.0	EH-014-207	EH-014-007	
	10.0	EH-014-208	EH-014-008	
	11.0	EH-014-209	EH-014-009	
	12.5	EH-014-210	EH-014-010	
Automatik Trokarhülse mit Silikonventil, Gewindemetallschaftrohr, mit <b>konischem Trokar</b>  <i>Automatic trocar sleeve with silicone valve, threaded metall tube, with <b>conical trocar</b></i>	5.5	EH-015-103	EH-015-003	
	11.0	EH-015-109	EH-015-009	
	12.5	EH-015-110	EH-015-010	
Automatik Trokarhülse mit Silikonventil, Gewindemetallschaftrohr, mit <b>dreikant Trokar</b>  <i>Automatic trocar sleeve with silicone valve, threaded metall tube, with <b>pyramidal trocar</b></i>	5.5	EH-015-203	EH-015-003	
	11.0	EH-015-209	EH-015-009	
	12.5	EH-015-210	EH-015-010	



**EH-114-103**  
bis / to  
**EH-114-111**



**EH-114-203**  
bis / to  
**EH-114-211**



**EH-115-103**  
bis / to  
**EH-115-111**



**EH-115-203**  
bis / to  
**EH-115-211**

	Ømm	Set inkl. Trokar Set incl. trocar	Hülse mit Schaftrohr Sleeve with tube	Farbe Colour	
Automatik Trokarhülse mit Silikonventil, Metallschaftrohr glatt, mit <b>konischem Trokar</b>  Automatic trocar sleeve with silicone valve, metal tube smooth, with <b>conical trocar</b>	5.5	EH-114-103	EH-114-003	Weiß/White	
	11.0	EH-114-109	EH-114-009	Blau/Blue	
	13.0	EH-114-111	EH-114-011	Grün/Green	
Automatik Trokarhülse mit Silikonventil, Metallschaftrohr glatt, mit <b>dreikant Trokar</b>  Automatic trocar sleeve with silicone valve, metal tube smooth, with <b>pyramidal trocar</b>	5.5	EH-114-203	EH-114-003	Weiß/White	
	11.0	EH-114-209	EH-114-009	Blau/Blue	
	13.0	EH-114-211	EH-114-011	Grün/Green	
Automatik Trokarhülse mit Silikonventil, Gewindemetallschaftrohr, mit <b>konischem Trokar</b>  Automatic trocar sleeve with silicone valve, threaded metal tube, with <b>conical trocar</b>	5.5	EH-115-103	EH-115-003	Weiß/White	
	11.0	EH-115-109	EH-115-009	Blau/Blue	
	13.0	EH-115-111	EH-115-011	Grün/Green	
Automatik Trokarhülse mit Silikonventil, Gewindemetallschaftrohr, mit <b>dreikant Trokar</b>  Automatic trocar sleeve with silicone valve, threaded metal tube, with <b>pyramidal trocar</b>	5.5	EH-115-203	EH-115-003	Weiß/White	
	11.0	EH-115-209	EH-115-009	Blau/Blue	
	13.0	EH-115-211	EH-115-011	Grün/Green	



**EH-016-103**  
bis / to  
**EH-016-110**



**EH-016-203**  
bis / to  
**EH-016-210**



**EH-017-103**  
bis / to  
**EH-017-110**



**EH-017-203**  
bis / to  
**EH-017-210**

	Ømm	Set inkl. Trokar Set incl. trocar	Hülse mit Schaffrohr Sleeve with tube	
<p>Automatik Trokarhülse mit Silikonventil, Kunststoffschaffrohr glatt, mit <b>konischem Trokar</b></p> <p><i>Automatic trocar sleeve with silicone valve, plastic tube smooth, with <b>conical trocar</b></i></p>	5.5	<b>EH-016-103</b>	<b>EH-016-003</b>	
	11.0	<b>EH-016-109</b>	<b>EH-016-009</b>	
	12.5	<b>EH-016-110</b>	<b>EH-016-010</b>	
<p>Automatik Trokarhülse mit Silikonventil, Kunststoffschaffrohr glatt, mit <b>dreikant Trokar</b></p> <p><i>Automatic trocar sleeve with silicone valve, plastic tube smooth, with <b>pyramidal trocar</b></i></p>	5.5	<b>EH-016-203</b>	<b>EH-016-003</b>	
	11.0	<b>EH-016-209</b>	<b>EH-016-009</b>	
	12.5	<b>EH-016-210</b>	<b>EH-016-010</b>	
<p>Automatik Trokarhülse mit Silikonventil, Gewindekunststoffschaffrohr, mit <b>konischem Trokar</b></p> <p><i>Automatic trocar sleeve with silicone valve, threaded plastic tube, with <b>conical trocar</b></i></p>	5.5	<b>EH-017-103</b>	<b>EH-017-003</b>	
	11.0	<b>EH-017-109</b>	<b>EH-017-009</b>	
	12.5	<b>EH-017-110</b>	<b>EH-017-010</b>	
<p>Automatik Trokarhülse mit Silikonventil, Gewindekunststoffschaffrohr, mit <b>dreikant Trokar</b></p> <p><i>Automatic trocar sleeve with silicone valve, threaded plastic tube, with <b>pyramidal trocar</b></i></p>	5.5	<b>EH-017-203</b>	<b>EH-017-003</b>	
	11.0	<b>EH-017-209</b>	<b>EH-017-009</b>	
	12.5	<b>EH-017-210</b>	<b>EH-017-010</b>	



**EH-116-103**  
bis / to  
**EH-116-111**



**EH-116-203**  
bis / to  
**EH-116-211**







**EH-117-103**  
bis / to  
**EH-117-111**













**EH-117-203**  
bis / to  
**EH-117-211**

	Ømm	Set inkl. Trokar Set incl. trocar	Hülse mit Schafftrohr Sleeve with tube	Farbe Colour	
Automatik Trokarhülse mit Silikonventil, Kunststoffschafftrohr glatt, mit <b>konischem Trokar</b> Automatic trocar sleeve with silicone valve, plastic tube smooth, with <b>conical trocar</b>	5.5	<b>EH-116-103</b>	<b>EH-116-003</b>	<b>Weiß/White</b>	
	11.0	<b>EH-116-109</b>	<b>EH-116-009</b>	<b>Blau/Blue</b>	
	13.0	<b>EH-116-111</b>	<b>EH-116-011</b>	<b>Grün/Green</b>	
Automatik Trokarhülse mit Silikonventil, Kunststoffschafftrohr glatt, mit <b>dreikant Trokar</b> Automatic trocar sleeve with silicone valve, plastic tube smooth, with <b>pyramidal trocar</b>	5.5	<b>EH-116-203</b>	<b>EH-116-003</b>	<b>Weiß/White</b>	
	11.0	<b>EH-116-209</b>	<b>EH-116-009</b>	<b>Blau/Blue</b>	
	13.0	<b>EH-116-211</b>	<b>EH-116-011</b>	<b>Grün/Green</b>	
Automatik Trokarhülse mit Silikonventil, Gewindekunststoffschaftrohr, mit <b>konischem Trokar</b> Automatic trocar sleeve with silicone valve, threaded plastic tube, with <b>conical trocar</b>	5.5	<b>EH-117-103</b>	<b>EH-117-003</b>	<b>Weiß/White</b>	
	11.0	<b>EH-117-109</b>	<b>EH-117-009</b>	<b>Blau/Blue</b>	
	13.0	<b>EH-117-111</b>	<b>EH-117-011</b>	<b>Grün/Green</b>	
Automatik Trokarhülse mit Silikonventil, Gewindekunststoffschaftrohr, mit <b>dreikant Trokar</b> Automatic trocar sleeve with silicone valve, threaded plastic tube, with <b>pyramidal trocar</b>	5.5	<b>EH-117-203</b>	<b>EH-117-003</b>	<b>Weiß/White</b>	
	11.0	<b>EH-117-209</b>	<b>EH-117-009</b>	<b>Blau/Blue</b>	
	13.0	<b>EH-117-211</b>	<b>EH-117-011</b>	<b>Grün/Green</b>	

	Ømm	Bestell-Nr. Ordering no.	Farbe Colour		
Metallschaftrohre glatt passend für Automatik-Trokarhülsen: EH-005-001 bis EH-005-010 EH-009-001 bis EH-009-011 EH-014-001 bis EH-014-010	3.5	EJ-015-001			
	5.5	EJ-015-003			
	11.0	EJ-015-009			
<i>Metal tubes smooth suitable for automatic trocar sleeves:</i> EH-005-001 to EH-005-010 EH-009-001 to EH-009-011 EH-014-001 to EH-014-010	12.5	EJ-015-010			
	13.0	EJ-015-011			
	<hr/>				
Gewindemetallschaftrohre passend für Automatik-Trokarhülsen: EH-006-003 bis EH-006-010 EH-015-003 bis EH-015-010 EH-028-003 bis EH-028-010	5.5	EJ-016-003			
	11.0	EJ-016-009			
	12.5	EJ-016-010			
<i>Threaded metal tubes suitable for automatic trocar sleeves:</i> EH-006-003 to EH-006-010 EH-015-003 to EH-015-010 EH-028-003 to EH-028-010	<hr/>				
	<hr/>				
	<hr/>				
Metallschaftrohre glatt passend für Automatik-Trokarhülsen: EH-109-001 bis EH-109-011 EH-114-003 bis EH-114-011	3.5	EJ-015-001			
	5.5	EJ-015-023	Weiß/White		
	11.0	EJ-015-029	Blau/Blue		
	13.0	EJ-015-031	Grün/Green		
Gewindemetallschaftrohre passend für Automatik-Trokarhülsen: EH-115-003 bis EH-115-011 EH-128-003 bis EH-128-011	5.5	EJ-016-023	Weiß/White		
	11.0	EJ-016-029	Blau/Blue		
	13.0	EJ-016-031	Grün/Green		
	<hr/>				



	Ømm	Bestell-Nr. Ordering no.	Farbe Colour	
Kunststoffschaftrohre glatt passend für Automatik-Trokarhülsen: EH-007-003 bis EH-007-010 EH-016-003 bis EH-016-010 EH-029-003 bis EH-029-010	5.5	EJ-017-023		
	11.0	EJ-017-029		
	12.5	EJ-017-020		
<i>Plastic tubes smooth suitable for automatic trocar sleeves:</i> EH-007-003 to EH-007-010 EH-016-003 to EH-016-010 EH-029-003 to EH-029-010				
Gewindekunststoffschaftrohre passend für Automatik-Trokarhülsen: EH-008-003 bis EH-008-010 EH-017-003 bis EH-017-010 EH-029-303 bis EH-029-310	5.5	EJ-017-003		
	11.0	EJ-017-009		
	12.5	EJ-017-010		
<i>Threaded plastic tubes suitable for automatic trocar sleeves:</i> EH-008-003 to EH-008-010 EH-017-003 to EH-017-010 EH-029-303 to EH-029-310				
Kunststoffschaftrohre glatt passend für Automatik-Trokarhülsen: EH-116-003 bis EH-116-011 EH-129-003 bis EH-129-011	5.5	EJ-017-030	Weiß/White	
	11.0	EJ-017-031	Blau/Blue	
	13.0	EJ-017-032	Grau/Grey	
<i>Plastic tubes smooth suitable for automatic trocar sleeves:</i> EH-116-003 to EH-116-011 EH-129-003 to EH-129-011				
Gewindekunststoffschaftrohre passend für Automatik-Trokarhülsen: EH-117-003 bis EH-117-011 EH-129-303 bis EH-129-311	5.5	EJ-017-013	Weiß/White	
	11.0	EJ-017-018	Blau/Blue	
	13.0	EJ-017-019	Grau/Grey	
<i>Threaded plastic tubes suitable for automatic trocar sleeves:</i> EH-117-003 to EH-117-011 EH-129-303 to EH-129-311				

	Ømm	Bestell-Nr. Ordering no.	Farbe Colour	
	3.5	EJ-020-001	Rot/Red	
Dichtkappen (10/Pack) passend für Automatik-Trokarhülsen: EH-009-001 bis EH-029-303	5.0/5.5	EJ-020-002	Rot/Red	
	7.0	EJ-020-004	Rot/Red	
Sealing caps (10/pack) suitable for automatic trocar sleeves: EH-009-001 to EH-029-303	8.0	EJ-020-005	Rot/Red	
	10.0/11.0	EJ-020-006	Blau/Blue	
	12.5	EJ-020-007	Grün/Green	
Dichtkappen (10/Pack) passend für Automatik-Trokarhülsen: EH-109-001 bis EH-129-303	5.5	EJ-020-011	Weiß/White	
	11.0	EJ-020-006	Blau/Blue	
Sealing caps (10/pack) suitable for automatic trocar sleeves: EH-109-001 to EH-129-303	13.0	EJ-020-012	Grün/Green	
Innendichtungen (10/Pack) passend für Automatik-Trokare: EH-005-001 bis EH-029-310	3.5	EJ-021-001	Schwarz/Black	
	5.0-8.0	EJ-021-002	Grau/Grey	
Inner seals (10/pack) suitable for automatic trocars: EH-005-001 to EH-029-310	10.0-13.0	EJ-021-003	Gelb/Yellow	
Innendichtungen (10/Pack) passend für Automatik-Trokare: EH-109-001 bis EH-129-311	3.5	EJ-021-001	Schwarz/Black	
	5.5	EJ-021-006	Weiß/White	
Inner seals (10/pack) suitable for automatic trocars: EH-109-001 to EH-129-311	11.0	EJ-021-007	Blau/Blue	
	13.0	EJ-021-008	Grün/Green	
Silikonventile (5/Pack) passend für Automatik-Trokare: EH-014-001 bis EH-117-011	3.5-8.0	EJ-023-001		
Silicone valves (5/pack) suitable for automatic trocars: EH-014-001 to EH-117-011	10.0-13.0	EJ-023-002		
O-Ringe (10/Pack):	3.5	EJ-022-001		
O-rings (10/pack):	5.0-8.0	EJ-022-002		
	10.0-13.0	EJ-022-003		





**EH-009-112**  
 bis / to  
**EH-009-113**



**EH-009-212**  
 bis / to  
**EH-009-213**

	Ømm	Set inkl. Trokar Set incl. trocar	Hülse mit Schaftrohr Sleeve with tube	
Automatik Trokarhülse mit manueller Klappenöffnung, Metallschaftrohr glatt, Gehäuse mit Gewindeverschluss, mit <b>konischem Trokar</b>	15.0	<b>EH-009-112</b>	<b>EH-009-012</b>	
Automatic trocar sleeve with separate opening lever, metal tube smooth, housing with winded locking, with <b>conical trocar</b>	20.0	<b>EH-009-113</b>	<b>EH-009-013</b>	
Automatik Trokarhülse mit manueller Klappenöffnung, Plastikschaftrohr glatt, Gehäuse mit Gewindeverschluss, mit <b>dreikant Trokar</b>	15.0	<b>EH-009-212</b>	<b>EH-009-012</b>	
Automatic trocar sleeve with separate opening lever, plastic tube smooth, housing with winded locking, with <b>pyramidal trocar</b>	20.0	<b>EH-009-213</b>	<b>EH-009-013</b>	

	Ømm	Bestell-Nr. Ordering no.	
Metallschaftrohre glatt passend für Automatik-Trokarhülsen: EH-009-012 und EH-009-013	15.0	<b>EJ-015-012</b>	
Metal tubes smooth suitable for automatic trocar sleeves: EH-009-012 and EH-009-013	20.0	<b>EJ-015-013</b>	

	<b>Ømm</b>	<b>Bestell-Nr. Ordering no.</b>	<b>Farbe Colour</b>	
Dichtkappen (2/Pack) passend für Automatik-Trokarhülsen: EH-009-012 und EH-009-013	<b>15.0</b>	<b>EJ-020-008</b>	<b>Grau/Grey</b>	
Sealing caps (2/pack) suitable for automatic trocar sleeves: EH-009-012 and EH-009-013	<b>20.0</b>	<b>EJ-020-009</b>	<b>Grau/Grey</b>	
Innendichtungen (1/Pack) passend für Automatik-Trokare: EH-009-012 und EH-009-013	<b>15.0</b>	<b>EJ-021-004</b>	<b>Grün/Green</b>	
Inner seals (1/pack) suitable for automatic trocars: EH-009-012 and EH-009-013	<b>20.0</b>	<b>EJ-021-005</b>	<b>Blau/Blue</b>	
O-Ringe (10/Pack): O-rings (10/pack):	<b>15.0/20.0</b>	<b>EJ-022-004</b>		



**EH-005-118**  
 bis / to  
**EH-005-120**







**EH-005-218**  
 bis / to  
**EH-005-220**



**EH-009-118**  
 bis / to  
**EH-009-120**



**EH-009-218**  
 bis / to  
**EH-009-220**

	Ømm	Set inkl. Trokar Set incl. trocar	Hülse mit Schaftrohr Sleeve with tube	
Automatik Trokarhülse, Metallschaftrohr glatt (150mm), Gehäuse mit Gewindeverschluss, mit <b>konischem Trokar</b>  Automatic trocar sleeve, metal tube smooth (150mm), housing with winded locking, with <b>conical trocar</b>	5.5	<b>EH-005-118</b>	<b>EH-005-018</b>	
	11.0	<b>EH-005-119</b>	<b>EH-005-019</b>	
	12.5	<b>EH-005-120</b>	<b>EH-005-020</b>	
Automatik Trokarhülse, Metallschaftrohr glatt (150mm), Gehäuse mit Gewindeverschluss, mit <b>dreikant Trokar</b>  Automatic trocar sleeve, metal tube smooth (150mm), housing with winded locking, with <b>pyramidal trocar</b>	5.5	<b>EH-005-218</b>	<b>EH-005-018</b>	
	11.0	<b>EH-005-219</b>	<b>EH-005-019</b>	
	12.5	<b>EH-005-220</b>	<b>EH-005-020</b>	
Automatik Trokarhülse mit manueller Klappenöffnung, Metallschaftrohr glatt (150mm), Gehäuse mit Gewindeverschluss, mit <b>konischem Trokar</b>  Automatic trocar sleeve with separate opening lever, metal tube smooth (150mm), housing with winded locking, with <b>conical trocar</b>	5.5	<b>EH-009-118</b>	<b>EH-009-018</b>	
	11.0	<b>EH-009-119</b>	<b>EH-009-019</b>	
	12.5	<b>EH-009-120</b>	<b>EH-009-020</b>	
Automatik Trokarhülse mit manueller Klappenöffnung, Metallschaftrohr glatt (150mm), Gehäuse mit Gewindeverschluss, mit <b>dreikant Trokar</b>  Automatic trocar sleeve with separate opening lever, metal tube smooth (150mm), housing with winded locking, with <b>pyramidal trocar</b>	5.5	<b>EH-009-218</b>	<b>EH-009-018</b>	
	11.0	<b>EH-009-219</b>	<b>EH-009-019</b>	
	12.5	<b>EH-009-220</b>	<b>EH-009-020</b>	







**EH-014-118**  
bis / to  
**EH-014-120**



**EH-014-218**  
bis / to  
**EH-014-220**

	Ømm	Set inkl. Trokar Set incl. trocar	Hülse mit Schaftrohr Sleeve with tube	
Automatik Trokarhülse mit Silikonventil, Metallschaftrohr glatt (150mm), mit <b>konischem Trokar</b>  <i>Automatic trocar sleeve with silicone valve, metal tube smooth (150mm), with <b>conical trocar</b></i>	5.5	<b>EH-014-118</b>	<b>EH-014-018</b>	
	11.0	<b>EH-014-119</b>	<b>EH-014-019</b>	
	12.5	<b>EH-014-120</b>	<b>EH-014-020</b>	
Automatik Trokarhülse mit Silikonventil, Metallschaftrohr glatt (150mm), mit <b>dreikant Trokar</b>  <i>Automatic trocar sleeve with silicone valve, metal tube smooth (150mm), with <b>pyramidal trocar</b></i>	5.5	<b>EH-014-218</b>	<b>EH-014-018</b>	
	11.0	<b>EH-014-219</b>	<b>EH-014-019</b>	
	12.5	<b>EH-014-220</b>	<b>EH-014-020</b>	

	Ømm	Bestell-Nr. Ordering no.	
Metallschaftrohre (150mm) glatt passend für Automatik-Trokarhülsen: EH-005-018 bis EH-005-020 EH-009-018 bis EH-009-020 EH-014-018 bis EH-014-020	5.5	EJ-015-015	
	11.0	EJ-015-016	
	12.5	EJ-015-017	
<i>Metal tubes (150mm) smooth suitable for automatic trocar sleeves: EH-005-018 to EH-005-020 EH-009-018 to EH-009-020 EH-014-018 to EH-014-020</i>			

	Ømm	Bestell-Nr. Ordering no.	Farbe Colour	
Dichtkappen (10/Pack) passend für alle Automatik-Trokarhülsen  Sealing caps (10/pack) suitable for all automatic trocar sleeves	3.5	EJ-020-001	Rot/Red	
	5.0/5.5	EJ-020-002	Rot/Red	
	7.0	EJ-020-004	Rot/Red	
	8.0	EJ-020-005	Rot/Red	
	10.0/11.0	EJ-020-006	Blau/Blue	
	12.5	EJ-020-007	Grün/Green	
	Innendichtungen (10/Pack) passend für Automatik-Trokare: EH-005-018 bis EH-009-020  Inner seals (10/pack) suitable for automatic trocars: EH-005-018 to EH-009-020	3.5	EJ-021-001	
5.0-8.0		EJ-021-002	Grau/Grey	
10.0-13.0		EJ-021-003	Gelb/Yellow	
Silikonventile (5/Pack) passend für Automatik-Trokare: EH-014-018 bis EH-014-020  Silicone valves (5/pack) suitable for automatic trocars: EH-014-018 to EH-014-020	3.5-8.0	EJ-023-001		
	10.0-13.0	EJ-023-002		
O-Ringe (10/Pack):  O-rings (10/pack):	3.5	EJ-022-001		
	5.0-8.0	EJ-022-002		
	10.0-13.0	EJ-022-003		



**EH-109-118**  
bis / to  
**EH-109-120**



**EH-109-218**  
bis / to  
**EH-109-220**

	Ømm	Set inkl. Trokar Set incl. trocar	Hülse mit Schaftrohr Sleeve with tube	Farbe Colour	
<p>Automatik Trokarhülse mit manueller Klappenöffnung, Metallschaftrohr glatt (150mm), Gehäuse mit Gewindeverschluss, mit <b>konischem Trokar</b></p> <p><i>Automatic trocar sleeve with seperate opening lever, metal tube smooth (150mm), housing with winded locking, with <b>conical trocar</b></i></p>	5.5	<b>EH-109-118</b>	<b>EH-109-018</b>	<b>Weiß/White</b>	
	11.0	<b>EH-109-119</b>	<b>EH-109-019</b>	<b>Blau/Blue</b>	
	13.0	<b>EH-109-120</b>	<b>EH-109-020</b>	<b>Grün/Green</b>	
<p>Automatik Trokarhülse mit manueller Klappenöffnung, Metallschaftrohr glatt (150mm), Gehäuse mit Gewindeverschluss, mit <b>dreikant Trokar</b></p> <p><i>Automatic trocar sleeve with seperate opening lever, metal tube smooth (150mm), housing with winded locking, with <b>pyramidal trocar</b></i></p>	5.5	<b>EH-109-218</b>	<b>EH-109-018</b>	<b>Weiß/White</b>	
	11.0	<b>EH-109-219</b>	<b>EH-109-019</b>	<b>Blau/Blue</b>	
	13.0	<b>EH-109-220</b>	<b>EH-109-020</b>	<b>Grün/Green</b>	









**EH-114-118**  
 bis / to  
**EH-114-120**



**EH-114-218**  
 bis / to  
**EH-114-220**

	Ømm	Set inkl. Trokar Set incl. trocar	Hülse mit Schaftrohr Sleeve with tube	Farbe Colour	
Automatik Trokarhülse mit Silikonventil, Metallschaftrohr glatt (150mm), mit <b>konischem Trokar</b> Automatic trocar sleeve with silicone valve, metal tube smooth (150mm), with <b>conical trocar</b>	5.5	<b>EH-114-118</b>	<b>EH-114-018</b>	<b>Weiß/White</b>	
	11.0	<b>EH-114-119</b>	<b>EH-114-019</b>	<b>Blau/Blue</b>	
	13.0	<b>EH-114-120</b>	<b>EH-114-020</b>	<b>Grün/Green</b>	
Automatik Trokarhülse mit Silikonventil, Metallschaftrohr glatt (150mm), mit <b>dreikant Trokar</b> Automatic trocar sleeve with silicone valve, metal tube smooth (150mm), with <b>pyramidal trocar</b>	5.5	<b>EH-114-218</b>	<b>EH-114-018</b>	<b>Weiß/White</b>	
	11.0	<b>EH-114-219</b>	<b>EH-114-019</b>	<b>Blau/Blue</b>	
	13.0	<b>EH-114-220</b>	<b>EH-114-020</b>	<b>Grün/Green</b>	

	Ømm	Bestell-Nr. Ordering no.	
Metallschaftrohre (150mm) glatt passend für Automatik-Trokarhülsen: EH-109-018 bis EH-109-020 EH-114-018 bis EH-114-020	5.5	EJ-015-033	
	11.0	EJ-015-039	
	12.5	EJ-015-041	
<i>Metal tubes (150mm) smooth suitable for automatic trocar sleeves:</i> EH-109-018 to EH-109-020 EH-114-018 to EH-114-020			

	Ømm	Bestell-Nr. Ordering no.	Farbe Colour	
Dichtkappen (10/Pack) passend für Automatik-Trokarhülsen: EH-109-018 bis EH-109-020 EH-114-018 bis EH-114-020	5.5	EJ-020-011	Weiß/White	
	11.0	EJ-020-006	Blau/Blue	
	13.0	EJ-020-012	Blau/Blue	
<i>Sealing caps (10/pack) suitable for automatic trocar sleeves:</i> EH-109-018 to EH-109-020 EH-114-018 to EH-114-020				
Innendichtungen (10/Pack) passend für Automatik-Trokare: EH-109-018 bis EH-109-020 EH-114-018 bis EH-114-020	5.5	EJ-021-006	Weiß/White	
	11.0	EJ-021-007	Blau/Blue	
	13.0	EJ-021-008	Grün/Green	
<i>Inner seals (10/pack) suitable for automatic trocars:</i> EH-109-018 to EH-109-020 EH-114-018 to EH-114-020				
Silikonventile (5/Pack) passend für Automatik-Trokare: EH-114-018 bis EH-114-020	3.5-8.0	EJ-023-001		
	10.0-13.0	EJ-023-002		
<i>Silicone valves (5/pack) suitable for automatic trocars:</i> EH-114-018 to EH-114-020				
O-Ringe (10/Pack): O-rings (10/pack):	5.5	EJ-022-006		
	11.0	EJ-022-007		
	13.0	EJ-022-008		

	Ømm	Bestell-Nr. Ordering no.	
	5.0	EH-030-002	
	5.5	EH-030-003	
Trokarstop, Länge 35mm, passend für alle Automatik-Trokarhülsen	10.0	EH-030-008	
Trocar stop, length 35mm, suitable for automatic trocar sleeves	11.0	EH-030-009	
	12.5	EH-030-010	



**Bestell-Nr.  
Ordering no.**

**EL-001-001** Bauchdeckenspekulum zur Gallenblasenextraktion  
Abdominal speculum for the extraction of the gall bladder



	Ømm	Bestell-Nr. Ordering no.	Ømm	Bestell-Nr. Ordering no.
Trokare, <b>dreikant</b> Trocars, <b>pyramidal</b>	3.0	EJ-001-001-1	10.0	EJ-001-008
	3.5	EJ-001-001	11.0	EJ-001-009
	5.0	EJ-001-002	12.5	EJ-001-010
	5.5	EJ-001-003	13.0	EJ-001-011
	7.0	EJ-001-006	15.0	EJ-001-012
	8.0	EJ-001-007	20.0	EJ-001-013
	Bariatric-Trokare, 150mm, <b>dreikant</b> Bariatric trocars, 150mm, <b>pyramidal</b>	5.5	EJ-001-018	13.0
	11.0	EJ-001-019		
	12.5	EJ-001-019-1		



	Ømm	Bestell-Nr. Ordering no.	Ømm	Bestell-Nr. Ordering no.
Trokare, <b>konisch</b> Trocars, <b>conical</b>	3.0	EJ-002-001-1	10.0	EJ-002-008
	3.5	EJ-002-001	11.0	EJ-002-009
	5.0	EJ-002-002	12.5	EJ-002-010
	5.5	EJ-002-003	13.0	EJ-002-011
	7.0	EJ-002-006	15.0	EJ-002-012
	8.0	EJ-002-007	20.0	EJ-002-013
	Bariatric-Trokare, 150mm, <b>konisch</b> Bariatric trocars, 150mm, <b>conical</b>	5.5	EJ-002-018	13.0
	11.0	EJ-002-019		
	12.5	EJ-002-019-1		



	Ømm	Bestell-Nr. Ordering no.	Ømm	Bestell-Nr. Ordering no.
Trokare, <b>stumpf</b> Trocars, <b>blunt</b>	3.5	EJ-011-001	10.0	EJ-011-008
	5.0	EJ-011-002	11.0	EJ-011-009
	5.5	EJ-011-003	12.5	EJ-011-010



	Ømm	Bestell-Nr. Ordering no.	Ømm	Bestell-Nr. Ordering no.
Trokare, durchlässig, <b>dreikant</b> (hohlschliff)	5.0	EJ-001-021	11.0	EJ-001-025
	5.5	EJ-001-022	12.5	EJ-001-026
Trocars, leaky, <b>pyramidal</b> (hollow grinded)	8.0	EJ-001-023	13.0	EJ-001-020
	10.0	EJ-001-024		
Bariatric-Trokare, 150mm, durchlässig, <b>dreikant</b> (hohlschliff) Bariatric trocars, 150mm, leaky, <b>pyramidal</b> (hollow grinded)	5.5	EJ-001-027	13.0	EJ-001-030
	11.0	EJ-001-028		
	12.5	EJ-001-029		



	Ømm	Bestell-Nr. Ordering no.	Ømm	Bestell-Nr. Ordering no.
Trokare, durchlässig, <b>konisch</b>	5.0	EJ-002-021	11.0	EJ-002-025
	5.5	EJ-002-022	12.5	EJ-002-026
Trocars, leaky, <b>conical</b>	8.0	EJ-002-023	13.0	EJ-002-020
	10.0	EJ-002-024		
Bariatric-Trokare, 150mm, durchlässig, <b>konisch</b> Bariatric trocars, 150mm, leaky, <b>conical</b>	5.5	EJ-002-027	13.0	EJ-001-030
	11.0	EJ-002-028		
	12.5	EJ-002-029		



	Ømm	Bestell-Nr. Ordering no.	Ømm	Bestell-Nr. Ordering no.
Sicherheitstrokare, <b>Dreikantschliff</b> , mit automatischem Verriegelungsmechanismus	5.0	EH-022-002	11.0	EH-022-009
	5.5	EH-022-003	12.5	EH-022-010
Safety trocars, <b>pyramidal tip</b> , with automatic locking mechanism	8.0	EH-022-007	13.0	EH-022-011
	10.0	EH-022-008		
Bariatric-Sicherheitstrokare, 150mm, <b>Dreikantschliff</b> , mit automatischem Verriegelungsmechanismus Bariatric safety trocars, 150mm, <b>pyramidal tip</b> , with automatic locking mechanism	5.5	EH-022-018	13.0	EH-022-021
	11.0	EH-022-019		
	12.5	EH-022-020		



	Ømm	Bestell-Nr. Ordering no.	Ømm	Bestell-Nr. Ordering no.
Sicherheitstrokare, <b>Halbmondschliff</b> , mit automatischem Verriegelungsmechanismus	5.0	EH-023-002	11.0	EH-023-009
	5.5	EH-023-003	12.5	EH-023-010
Safety trocars, <b>half moon tip</b> , with automatic locking mechanism	8.0	EH-023-007	13.0	EH-023-011
	10.0	EH-023-008		



	Ømm	Bestell-Nr. Ordering no.	Ømm	Bestell-Nr. Ordering no.
Sicherheitstrokare, <b>Halbmondschliff</b>	5.0	EH-024-002	10.0	EH-024-008
	5.5	EH-024-003	11.0	EH-024-009
Safety trocars, <b>half moon tip</b>	8.0	EH-024-007	12.5	EH-024-010



	Ømm	Bestell-Nr. Ordering no.	Ømm	Bestell-Nr. Ordering no.
Sicherheitstrokare, <b>Halbmondschliff</b> , V-förmig	5.0	EH-024-020	10.0	EH-024-023
	5.5	EH-024-021	11.0	EH-024-024
Safety trocars, <b>half moon tip</b> , V-shape	8.0	EH-024-022	12.5	EH-024-025



	Ømm	Bestell-Nr. Ordering no.	Ømm	Bestell-Nr. Ordering no.
Sicherheitstrokare, <b>Messerform</b> , mit automatischem Verriegelungsmechanismus Safety trocars, <b>knife type</b> , with automatic locking mechanism	5.5	EH-022-033	13.0	EH-022-036
	11.0	EH-022-034		
	12.5	EH-022-035		



	Ømm	Bestell-Nr. Ordering no.
Sicherheitstroker, <b>stumpf</b> Safety trocar, <b>blunt</b>	3.5	EH-025-001

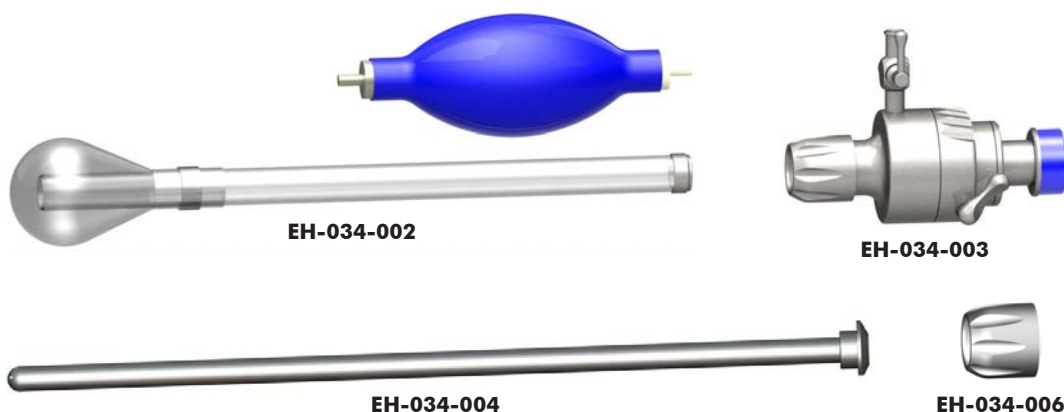

**Bestell-Nr.  
Ordering no.**

**EH-034-001** Dilatation Ballon System komplett, bestehend aus:  
*Dilatation balloon system complete, consisting of:*

**EH-034-002** Steriles Ballonset inkl. Ballonpumpe, 5 Stück  
*Sterile balloon set incl. balloon pump, 5 pieces*

**EH-034-003** Ø 11 mm Automatiktrokarhülse mit Hahn  
*Ø 11 mm automatic trocar sleeve with stopcock*

**EH-034-004** Ø 10mm Trokar  
*Ø 10mm trocar*

**EH-034-005** Abdichtungskonus (ohne Abbildung)  
*Sealing cone (without illustration)*

**EH-034-006** Spannmutter  
*Tension nut*



	Ømm	Bestell-Nr. Ordering no.	Ømm	Bestell-Nr. Ordering no.
Reduzierhülsen <i>Reducer sleeves</i>	5.5 > 3.0	EH-032-011	15.0 > 10.0	EH-032-005
	10.0 > 5.5	EH-032-001	15.0 > 5.5	EH-032-006
	11.0 > 5.5	EH-032-002	20.0 > 15.0	EH-032-007
	12.5 > 10.0	EH-032-003	20.0 > 10.0	EH-032-008
	12.5 > 5.5	EH-032-004	20.0 > 5.5	EH-032-009

	Ømm	Bestell-Nr. Ordering no.	Ømm	Bestell-Nr. Ordering no.
Kunststoffreduzierer <i>Plastic reducer</i>	5.5 > 3.0	EH-032-020	12.5 > 5.5	EH-032-026
	10.0 > 5.5	EH-032-021	15.0 > 10.0	EH-032-027
	11.0 > 5.5	EH-032-022	13.0 > 5.5	EH-032-028
	15.0 > 5.5	EH-032-023	20.0 > 10.0	EH-032-029
	20.0 > 5.5	EH-032-024	13.0 > 10.0	EH-032-030
	12.5 > 10.0	EH-032-025		



	Ømm	Bestell-Nr. Ordering no.	Ømm	Bestell-Nr. Ordering no.
Kunststoffreduzierer mit Silikonlasche <i>Plastic reducer with silicone latch</i>	8.0 > 5.5	EH-032-033	12.5 > 10.0	EH-032-035
	10.0 > 5.5	EH-032-031	13.0 > 5.5	EH-032-038
	11.0 > 5.5	EH-032-032	13.0 > 10.0	EH-032-039
	11.0 > 8.0	EH-032-034		
	12.5 > 5.5	EH-032-036		
	12.5 > 8.0	EH-032-037		



	Ømm	Bestell-Nr. Ordering no.
Kunststoffreduzierer <i>Plastic reducer</i>	10.0 > 5.5	EH-032-041
	11.0 > 5.5	EH-032-042
	12.5 > 10.0	EH-032-045
	12.5 > 5.5	EH-032-046
	13.0 > 5.5	EH-032-047
	13.0 > 10.0	EH-032-048







**Bestell-Nr.  
 Ordering no.**

**EH-032-010** Applikator für Endo-Naht, Ø 5.0mm > 4.0mm, Arbeitslänge 180mm  
 Applicator for Endo-Ligature, Ø 5.0mm > 4.0mm, working length 180mm



	Ømm Nadel Ømm needle	Arbeitslänge Working length	Bestell-Nr. Ordering no.
<b>Ø 5mm</b> Injektionskanüle, Nadellänge 20mm  <b>Ø 5mm</b> injection needle, length of needle 20mm	0.7	330mm	EH-041-001
	0.7	450mm	EH-041-002
	0.9	330mm	EH-041-003
	0.9	450mm	EH-041-004
	1.2	330mm	EH-041-005
	1.2	450mm	EH-041-006
	1.4	330mm	EH-041-007
	1.4	450mm	EH-041-008
	1.5	330mm	EH-041-009
	1.5	450mm	EH-041-010
	1.8	330mm	EH-041-011
	1.8	450mm	EH-041-012
<b>Ø 2.8mm</b> Injektionskanüle, Nadellänge 20mm <b>Ø 2.8mm</b> injection needle, length of needle 20mm	1.2	330mm	EH-041-025



	Ømm	Arbeitslänge Working length	Bestell-Nr. Ordering no.	Ømm	Arbeitslänge Working length	Bestell-Nr. Ordering no.
Taststab graduert	5	300mm	EH-042-001	2	330mm	EH-042-011
	5	330mm	EH-042-002	2.8	330mm	EH-042-012
Palpation probe graduated	5	400mm	EH-042-003	2.8	250mm	EH-042-013
	5	450mm	EH-042-004			



	Ømm	Bestell-Nr. Ordering no.	Ømm	Bestell-Nr. Ordering no.
Dilatationssatz	5.0 - 10.0	EH-040-001	10.0 - 15.0	EH-040-005
	5.0 - 11.0	EH-040-002	10.0 - 20.0	EH-040-006
Dilation set	5.0 - 15.0	EH-040-003		
	5.0 - 20.0	EH-040-004		



**Bestell-Nr.**  
**Ordering no.**

**EH-035-001**     $\varnothing$  5mm Saug-Spülkanüle mit Schiebeventil, Rundlochsauger mit 4 Bohrungen, Arbeitslänge 330mm  
 *$\varnothing$  5mm suction-irrigation cannula with sliding valve, roundhole sucker with 4 drillings, working length 330mm*



**Bestell-Nr.**  
**Ordering no.**

**EH-035-002**     $\varnothing$  5mm Saug-Spülkanüle mit Schlauchanschluss, Rundlochsauger mit 4 Bohrungen, Arbeitslänge 330mm  
 *$\varnothing$  5mm suction-irrigation cannula with tube connection, roundhole sucker with 4 drillings, working length 330mm*



**Bestell-Nr.**  
**Ordering no.**

**EH-035-003**     $\varnothing$  5mm Saug-Spülkanüle mit LL-Anschluss, Rundlochsauger mit 4 Bohrungen, Arbeitslänge 330mm  
 *$\varnothing$  5mm suction-irrigation cannula with LL-connection, roundhole sucker with 4 drillings, working length 330mm*



**Bestell-Nr.**  
**Ordering no.**

**EH-035-004**     $\varnothing$  5mm Saug-Spülkanüle mit LL-Anschluss und Hahn, Sauger graduiert, 16 Bohrungen, Arbeitslänge **330mm**  
 *$\varnothing$  5mm suction-irrigation cannula with LL-connection and stopcock, tube with 16 drillings, working length **330mm***

**EH-035-005**     $\varnothing$  5mm Saug-Spülkanüle mit LL-Anschluss und Hahn, Sauger graduiert, 16 Bohrungen, Arbeitslänge **450mm**  
 *$\varnothing$  5mm suction-irrigation cannula with LL-connection and stopcock, tube with 16 drillings, working length **450mm***



**Bestell-Nr.**  
**Ordering no.**

**EH-039-001**     $\varnothing$  5mm Saug-Spülrohr mit 4 Bohrungen, Arbeitslänge 330mm  
 *$\varnothing$  5mm suction-irrigation tube with 4 drillings, working length 330mm*



**Bestell-Nr.  
Ordering no.**

<b>EH-035-041</b>	Ø 5mm Saug-Spülkanüle, Trompetenventilausführung, Rundlochsauger mit 4 Bohrungen, Arbeitslänge 330mm Ø 5mm suction-irrigation cannula, trumpet valve type, roundhole sucker with 4 drillings, working length 330mm
<b>EH-035-040</b>	Ø 5mm Saug-Spülkanüle mit Laserführung, Trompetenventilausführung, Rundlochsauger mit 4 Bohrungen, AL 330mm Ø 5mm suction-irrigation cannula with laser guide, trumpet valve type, roundhole sucker with 4 drillings, WL 330mm
<b>EH-035-042</b>	Laserführung mit Luer-Lock Verbindung Laser guide with Luer-Lock connection

**Bestell-Nr.  
Ordering no.**

Ø 5mm Saug-Spül Handgriff mit Schiebeventil für Rohre:  
EH-035-021 bis EH-035-028

**EH-035-011**



Ø 5mm suction-irrigation handle with sliding valve for tubes:  
EH-035-021 to EH-035-028

Ø 5mm Saug-Spül Handgriff mit Schlauchanschluss für Rohre:  
EH-035-021 bis EH-035-028

**EH-035-012**



Ø 5mm suction-irrigation handle with tube connection for tubes:  
EH-035-021 to EH-035-028

Ø 5mm Saug-Spül Handgriff mit Luer-Lock Anschluss für Rohre:  
EH-035-021 bis EH-035-028

**EH-035-013**



Ø 5mm suction-irrigation handle with Luer-Lock connection for tubes:  
EH-035-021 to EH-035-028

**Bestell-Nr.  
Ordering no.**      **Arbeitslänge  
Working length**

Ø 5mm Saug-Spülrohr mit 4 Bohrungen  
Ø 5mm suction-irrigation tube with 4 drillings

**EH-035-021**      **330mm**

**EH-035-043**      **450mm**

Ø 5mm Saug-Spülrohr mit 16 Bohrungen  
Ø 5mm suction-irrigation tube with 16 drillings

**EH-035-022**      **328mm**

**EH-035-036**      **450mm**



Ø 10mm Saug-Spülrohr mit 32 Bohrungen  
Ø 10mm suction-irrigation tube with 32 drillings

**EH-035-037**      **330mm**

Ø 5mm Saug-Spülrohr, Rundloch-Bienenkorbsauger  
Ø 5mm suction-irrigation tube, roundhole bee hive sucker

**EH-035-023**      **330mm**



Ø 5mm Saug-Spülrohr, stumpfer Bienenkorbsauger  
Ø 5mm suction-irrigation tube, stump bee hive sucker

**EH-035-024**      **330mm**

**EH-035-025**      **500mm**



Ø 5mm Saug-Spülrohr, Punktionsnadelsauger  
Ø 5mm suction-irrigation tube, puncture needle sucker

**EH-035-026**      **330mm**



Ø 5mm Saug-Spülrohr, Aqua-Dissektionskanüle  
Ø 5mm suction-irrigation tube, Aqua dissection cannula



**EH-035-027**      **330mm**



Ø 5mm Saug-Spülrohr, stumpfer Sauger  
Ø 5mm suction-irrigation tube, stump sucker

**EH-035-028**      **330mm**



	<b>Bestell-Nr.</b> <b>Ordering no.</b>	
<p>Ø 10mm Saug-Spülkanüle mit großem Schlauchanschluss und seitlichem LL-Anschluss                      Ø 10mm suction-irrigation handle with large tube connection and sidewise LL-connection</p>	<b>EH-035-017</b>	
<p>Ø 10mm Saug-Spülkanüle mit großem Schlauchanschluss und seitlichem LL-Anschluss, <b>komplett</b> mit 5 und 10mm Rohrset, AL 330mm                      Ø 10mm suction-irrigation handle with large tube connection and sidewise LL-connection <b>complete</b> with 5 and 10mm tube set, WL 330mm</p>	<b>EH-035-007</b>	
<p>Ø 10mm Saug-Spülkanüle mit kleinem Schlauchanschluss und seitlichem LL-Anschluss                      Ø 10mm suction-irrigation handle with small tube connection and sidewise LL-connection</p>	<b>EH-035-018</b>	
<p>Ø 10mm Saug-Spülkanüle mit kleinem Schlauchanschluss und seitlichem LL-Anschluss, <b>komplett</b> mit 5 und 10mm Rohrset, AL 330mm                      Ø 10mm suction-irrigation handle with small tube connection and sidewise LL-connection <b>complete</b> with 5 and 10mm tube set, WL 330mm</p>	<b>EH-035-008</b>	



**Bestell-Nr.**  
**Ordering no.**

- EH-038-033**    Ø 3.5mm Saug-Spülrohr mit 8 Bohrungen, für 10mm Saug-Spül Handgriff, Arbeitslänge 240mm  
 Ø 3.5mm suction-irrigation tube with 8 drillings, for 10 mm suction-irrigation handle, working length 240mm



**Bestell-Nr.**  
**Ordering no.**

- EH-035-029**    Ø 5mm Saug-Spülrohr, für 10mm Saug-Spül Handgriffe, Arbeitslänge 330mm  
 Ø 5mm suction-irrigation tube, for 10mm suction-irrigation handle, working length 330mm



**Bestell-Nr.**  
**Ordering no.**

- EH-035-030**    Ø 10mm Saug-Spülrohr, für 10mm Saug-Spül Handgriffe, Arbeitslänge 330mm  
 Ø 10mm suction-irrigation tube, for 10mm suction-irrigation handle, working length 330mm
- EH-035-030-45**    Ø 10mm Saug-Spülrohr, für 10mm Saug-Spül Handgriffe, Arbeitslänge 450mm  
 Ø 10mm suction-irrigation tube, for 10mm suction-irrigation handle, working length 450mm

**Bestell-Nr.**  
**Ordering no.**

Ø 5mm Saug-Spül Handgriff mit Schiebeventil, Drehadapter  
Ø 5mm suction-irrigation handle with sliding valve, rotating adapter

**EH-035-014**



**Bestell-Nr.**  
**Ordering no.**

<b>EH-035-034</b>	Ø <b>3mm</b> Saug-Spülrohr für Saug-Spülhandgriff (Schiebeventil), 4 Bohrungen, Arbeitslänge 340mm Ø <b>3mm</b> suction-irrigation tube for suction-irrigation handle (sliding valve), 4 drillings, working length 340mm
<b>EH-035-035</b>	Ø <b>5mm</b> Saug-Spülrohr für Saug-Spülhandgriff (Schiebeventil), 4 Bohrungen, Arbeitslänge 340mm Ø <b>5mm</b> suction-irrigation tube for suction-irrigation handle (sliding valve), 4 drillings, working length 340mm
<b>EH-035-038</b>	Ø <b>3mm</b> Saug-Spülrohr für Saug-Spülhandgriff (Schiebeventil), 16 Bohrungen, Arbeitslänge 340mm Ø <b>3mm</b> suction-irrigation tube for suction-irrigation handle (sliding valve), 16 drillings, working length 340mm
<b>EH-035-039</b>	Ø <b>5mm</b> Saug-Spülrohr für Saug-Spülhandgriff (Schiebeventil), 16 Bohrungen, Arbeitslänge 340mm Ø <b>5mm</b> suction-irrigation tube for suction-irrigation handle (sliding valve), 16 drillings, working length 340mm



**Bestell-Nr.**  
**Ordering no.**

<b>EH-035-037</b>	Ø 10mm Saug-Spülrohr für Saug-Spülhandgriff (Schiebeventil), 4 Bohrungen, Arbeitslänge 340mm Ø 10mm suction-irrigation tube for suction-irrigation handle (sliding valve), 4 drillings, working length 340mm
<b>EH-035-045</b>	Ø 10mm Saug-Spülrohr für Saug-Spülhandgriff (Schiebeventil), 16 Bohrungen, Arbeitslänge 340mm Ø 10mm suction-irrigation tube for suction-irrigation handle (sliding valve), 16 drillings, working length 340mm

	<b>Bestell-Nr.</b> <b>Ordering no.</b>	
Saug-Spülhandgriff mit Trompetenventil für adaptierbare Rohre (M8x1 mm) <i>Suction-irrigation handle with trumpet valve for adaptable tubes (M8x1 mm)</i>	<b>EH-036-001</b>	

	<b>Bestell-Nr.</b> <b>Ordering no.</b>	
Saug-Spül-Pistolenhandgriff mit Schiebeventil für adaptierbare Rohre (M8x1 mm) <i>Suction-irrigation pistol handle with sliding valve for adaptable tubes (M8x1 mm)</i>	<b>EH-036-003</b>	



**Bestell-Nr.**  
**Ordering no.**

**EH-036-024** Adaptierbares Ø 5mm Saug-Spülrohr (M8x1mm), Punktionsnadelsauger, Ø Nadel 1.5mm, Arbeitslänge 330mm  
Adaptable Ø 5mm suction-irrigation tube (M8x1mm), puncture needle sucker, Ø needle 1.5mm, working length 330mm



**Bestell-Nr.**  
**Ordering no.**

**EH-036-011** Adaptierbares Ø 3mm Saug-Spülrohr (M8x1mm), 4 Bohrungen, Arbeitslänge 340mm  
Adaptable Ø 3mm suction-irrigation tube (M8x1mm), 4 holes, working length 340mm



**EH-036-021** Adaptierbares Ø 3mm Saug-Spülrohr (M8x1mm), 16 Bohrungen, Arbeitslänge 340mm  
Adaptable Ø 3mm suction-irrigation tube (M8x1mm), 16 holes, working length 340mm



**Bestell-Nr.**  
**Ordering no.**

**EH-036-012** Adaptierbares Ø 5mm Saug-Spülrohr (M8x1mm), 4 Bohrungen, Arbeitslänge 340mm  
Adaptable Ø 5mm suction-irrigation tube (M8x1mm), 4 holes, working length 340mm



**EH-036-022** Adaptierbares Ø 5mm Saug-Spülrohr (M8x1mm), 16 Bohrungen, Arbeitslänge 340mm  
Adaptable Ø 5mm suction-irrigation tube (M8x1mm), 16 holes, working length 340mm



**Bestell-Nr.**  
**Ordering no.**

**EH-036-013** Adaptierbares Ø 10mm Saug-Spülrohr (M8x1mm), 4 Bohrungen, Arbeitslänge 340mm  
Adaptable Ø 10mm suction-irrigation tube (M8x1mm), 4 holes, working length 340mm



**EH-036-023** Adaptierbares Ø 10mm Saug-Spülrohr (M8x1mm), 16 Bohrungen, Arbeitslänge 340mm  
Adaptable Ø 10mm suction-irrigation tube (M8x1mm), 16 holes, working length 340mm



	<b>Bestell-Nr.</b> <b>Ordering no.</b>	
<p>Saug-Spül-Pistolenhandgriff (Schiebeventil) mit Schlauchanschlüssen</p> <p><i>Suction-irrigation pistol handle (sliding valve) with tube connections</i></p>	<b>EH-035-019</b>	
<p>∅ 10mm Saug-Spülkanüle mit Pistolenhandgriff (Schiebeventil) mit Schlauchanschlüssen, komplett mit 5 und 10mm Rohr-Set, Arbeitslänge 330mm</p> <p><i>∅ 10mm suction-irrigation cannula with pistol handle (sliding valve) with tube connections, complete with 5 and 10mm tube set, working length 330mm</i></p>	<b>EH-035-009</b>	



<b>Bestell-Nr.</b> <b>Ordering no.</b>	
<b>EH-035-031</b>	<p>∅ 3mm Saug-Spülrohr, für Saug-Spül-Pistolenhandgriff (Schiebeventil), Arbeitslänge 330mm</p> <p><i>∅ 3mm suction-irrigation tube, for suction-irrigation pistol handle (sliding valve), working length 330mm</i></p>



<b>Bestell-Nr.</b> <b>Ordering no.</b>	
<b>EH-035-032</b>	<p>∅ 5mm Saug-Spülrohr, für Saug-Spül-Pistolenhandgriff (Schiebeventil), Arbeitslänge 330mm</p> <p><i>∅ 5mm suction-irrigation tube, for suction-irrigation pistol handle (sliding valve), working length 330mm</i></p>



<b>Bestell-Nr.</b> <b>Ordering no.</b>	
<b>EH-035-033</b>	<p>∅ 10mm Saug-Spülrohr, für Saug-Spül-Pistolenhandgriff (Schiebeventil), Arbeitslänge 330mm</p> <p><i>∅ 10mm suction-irrigation tube, for suction-irrigation pistol handle (sliding valve), working length 330mm</i></p>





**Bestell-Nr.**  
**Ordering no.**

**EH-035-060**

Saug-Spül-Pistolenhandgriff mit Schlauchanschlüssen und 5mm Instrumentenkanal  
Suction-irrigation pistol handle with tube connections and 5mm instrument channel



**Bestell-Nr.**  
**Ordering no.**

**EH-035-061**

Adaptierbares Ø 10mm Saug-Spülrohr (M8x1mm), Metall, für 5mm Instrumente  
Adaptable Ø 10mm suction-irrigation tube (M8x1mm), metal, for 5mm instruments



**Bestell-Nr.**  
**Ordering no.**





**EH-035-062**

Adaptierbares Ø 10mm Saug-Spülrohr (M8x1mm), Kunststoff, für 5mm Instrumente  
Adaptable Ø 10mm suction-irrigation tube (M8x1mm), plastic, for 5mm instruments

	<b>Bestell-Nr.</b> <b>Ordering no.</b>	
Saug-Spül-Pistolenhandgriff (Schiebeventil) mit Schlauchanschlüssen <i>Suction-irrigation pistol handle (sliding valve) with tube connections</i>	<b>EH-035-019</b>	
Ø 10mm Saug-Spülkanüle mit Pistolenhandgriff (Schiebeventil) mit Schlauchanschlüssen, komplett mit 5 und 10mm Rohr-Set, Arbeitslänge 330mm <i>Ø 10mm suction-irrigation cannula with pistol handle (sliding valve) with tube connections, complete with 5 and 10mm tube set, working length 330mm</i>	<b>EH-035-009</b>	





	<b>Bestell-Nr.</b> <b>Ordering no.</b>	
Elektrodenadapter für Saug-Spül-Pistolenhandgriff <i>Adapter for electrodes for suction-irrigation pistol handle</i>	<b>EE-004-000</b>	



<b>Bestell-Nr.</b> <b>Ordering no.</b>		
<b>EE-004-006</b>	Ø 5.0mm austauschbare Knopfelektrode für Saug-Spül-Pistolenhandgriff, 330mm Ø 5.0mm exchangeable button electrode for suction-irrigation pistol handle, 330mm	
<b>EE-004-003</b>	Ø 5.0mm austauschbare J-Hakenelektrode für Saug-Spül-Pistolenhandgriff, 330mm Ø 5.0mm exchangeable J-hook electrode for suction-irrigation pistol handle, 330mm	
<b>EE-004-002</b>	Ø 5.0mm austauschbare 90° Hakenelektrode für Saug-Spül-Pistolenhandgriff, 330mm Ø 5.0mm exchangeable 90° hook electrode for suction-irrigation pistol handle, 330mm	
<b>EE-004-005</b>	Ø 5.0mm austauschbare Spatenelektrode für Saug-Spül-Pistolenhandgriff, 330mm Ø 5.0mm exchangeable spatula electrode electrode for suction-irrigation pistol handle, 330mm	
<b>EE-004-001</b>	Ø 5.0mm austauschbare Nadelelektrode für Saug-Spül-Pistolenhandgriff, 330mm Ø 5.0mm exchangeable needle electrode for suction-irrigation pistol handle, 330mm	











	<b>Bestell-Nr. Ordering no.</b>	
<p>Trompetenventil mit Elektrodenadapter für austauschbare Elektroden</p> <p><i>Trumpet valve with electrode adapter for exchangeable electrodes</i></p>	<b>EE-004-021</b>	
<p>Saug-Spül Schiebeventil mit Elektrodenadapter für austauschbare Elektroden</p> <p><i>Suction-irrigation slide valve with electrode adapter for exchangeable electrodes</i></p>	<b>EE-004-022</b>	
<p>Handgriff mit Doppel-Trompetenventil mit Elektrodenadapter für austauschbare Elektroden</p> <p><i>Handle with double trumpet valve with electrode adapter for exchangeable electrodes</i></p>	<b>EE-004-024</b>	
<p>Pistolenhandgriff mit Schiebeventil mit Elektrodenadapter für austauschbare Elektroden</p> <p><i>Pistol handle with sliding valve with electrode adaptor for exchangeable electrodes</i></p>	<b>EE-004-025</b>	



<b>Bestell-Nr. Ordering no.</b>		
<b>EE-004-006</b>	<p>Ø 5.0mm austauschbare Knopfelektrode für Handgriffe mit Adapter, 330mm</p> <p><i>Ø 5.0mm exchangeable button electrode for handles with adapter, 330mm</i></p>	
<b>EE-004-003</b>	<p>Ø 5.0mm austauschbare J-Hakenelektrode für Handgriffe mit Adapter, 330mm</p> <p><i>Ø 5.0mm exchangeable J-hook electrode for handles with adapter, 330mm</i></p>	
<b>EE-004-002</b>	<p>Ø 5.0mm austauschbare 90° Hakenelektrode für Handgriffe mit Adapter, 330mm</p> <p><i>Ø 5.0mm exchangeable 90° hook electrode for handles with adapter, 330mm</i></p>	
<b>EE-004-005</b>	<p>Ø 5.0mm austauschbare Spatenelektrode für Handgriffe mit Adapter, 330mm</p> <p><i>Ø 5.0mm exchangeable spatula electrode electrode for handles with adapter, 330mm</i></p>	
<b>EE-004-001</b>	<p>Ø 5.0mm austauschbare Nadelelektrode für Handgriffe mit Adapter, 330mm</p> <p><i>Ø 5.0mm exchangeable needle electrode for handles with adapter, 330mm</i></p>	













**Bestell-Nr.**  
**Ordering no.**

<b>EE-001-006</b>	Ø 5.0mm monopolare Knopfelektrode, <b>330mm</b> Ø 5.0mm monopolar button electrode, <b>330mm</b>	
<b>EE-001-016</b>	Ø 5.0mm monopolare Knopfelektrode, <b>450mm</b> Ø 5.0mm monopolar button electrode, <b>450mm</b>	
<b>EE-001-003</b>	Ø 5.0mm monopolare J-Hakenelektrode, <b>330mm</b> Ø 5.0mm monopolar J-hook electrode, <b>330mm</b>	
<b>EE-001-013</b>	Ø 5.0mm monopolare J-Hakenelektrode, <b>450mm</b> Ø 5.0mm monopolar J-hook electrode, <b>450mm</b>	
<b>EE-001-002</b>	Ø 5.0mm monopolare 90° Hakenelektrode, <b>330mm</b> Ø 5.0mm monopolar 90° hook electrode, <b>330mm</b>	
<b>EE-001-012</b>	Ø 5.0mm monopolare 90° Hakenelektrode, <b>450mm</b> Ø 5.0mm monopolar 90° hook electrode, <b>450mm</b>	
<b>EE-001-005</b>	Ø 5.0mm monopolare Spatelektrode, <b>330mm</b> Ø 5.0mm monopolar spatula electrode, <b>330mm</b>	
<b>EE-001-015</b>	Ø 5.0mm monopolare Spatelektrode, <b>450mm</b> Ø 5.0mm monopolar spatula electrode, <b>450mm</b>	
<b>EE-001-001</b>	Ø 5.0mm monopolare Nadelelektrode, <b>330mm</b> Ø 5.0mm monopolar needle electrode, <b>330mm</b>	
<b>EE-001-011</b>	Ø 5.0mm monopolare Nadelelektrode, <b>450mm</b> Ø 5.0mm monopolar needle electrode, <b>450mm</b>	



**Bestell-Nr.**  
**Ordering no.**

<b>EE-001-026</b>	Ø 5.0mm monopolare Knopfelektrode mit Luer-Lock Adapter, <b>330mm</b> Ø 5.0mm monopolar button electrode with Luer-Lock adapter, <b>330mm</b>	
<b>EE-001-036</b>	Ø 5.0mm monopolare Knopfelektrode mit Luer-Lock Adapter, <b>450mm</b> Ø 5.0mm monopolar button electrode with Luer-Lock adapter, <b>450mm</b>	
<b>EE-001-023</b>	Ø 5.0mm monopolare J-Hakenelektrode mit Luer-Lock Adapter, <b>330mm</b> Ø 5.0mm monopolar J-hook electrode with Luer-Lock adapter, <b>330mm</b>	
<b>EE-001-033</b>	Ø 5.0mm monopolare J-Hakenelektrode mit Luer-Lock Adapter, <b>450mm</b> Ø 5.0mm monopolar J-hook electrode with Luer-Lock adapter, <b>450mm</b>	
<b>EE-001-022</b>	Ø 5.0mm monopolare 90° Hakenelektrode mit Luer-Lock Adapter, <b>330mm</b> Ø 5.0mm monopolar 90° hook electrode with Luer-Lock adapter, <b>330mm</b>	
<b>EE-001-032</b>	Ø 5.0mm monopolare 90° Hakenelektrode mit Luer-Lock Adapter, <b>450mm</b> Ø 5.0mm monopolar 90° hook electrode with Luer-Lock adapter, <b>450mm</b>	
<b>EE-001-025</b>	Ø 5.0mm monopolare Spatelektrode mit Luer-Lock Adapter, <b>330mm</b> Ø 5.0mm monopolar spatula electrode with Luer-Lock adapter, <b>330mm</b>	
<b>EE-001-035</b>	Ø 5.0mm monopolare Spatelektrode mit Luer-Lock Adapter, <b>450mm</b> Ø 5.0mm monopolar spatula electrode with Luer-Lock adapter, <b>450mm</b>	
<b>EE-001-021</b>	Ø 5.0mm monopolare Nadelelektrode mit Luer-Lock Adapter, <b>330mm</b> Ø 5.0mm monopolar needle electrode with Luer-Lock adapter, <b>330mm</b>	
<b>EE-001-031</b>	Ø 5.0mm monopolare Nadelelektrode mit Luer-Lock Adapter, <b>450mm</b> Ø 5.0mm monopolar needle electrode with Luer-Lock adapter, <b>450mm</b>	



**Bestell-Nr.**  
**Ordering no.**

<b>EE-001-046</b>	Ø 5.0mm monopolare Knopfelektrode mit Trompetenventil, <b>330mm</b> Ø 5.0mm monopolar button electrode with trumpet valve, <b>330mm</b>	
<b>EE-001-056</b>	Ø 5.0mm monopolare Knopfelektrode mit Trompetenventil, <b>450mm</b> Ø 5.0mm monopolar button electrode with trumpet valve, <b>450mm</b>	
<b>EE-001-043</b>	Ø 5.0mm monopolare J-Hakenelektrode mit Trompetenventil, <b>330mm</b> Ø 5.0mm monopolar J-hook electrode with trumpet valve, <b>330mm</b>	
<b>EE-001-053</b>	Ø 5.0mm monopolare J-Hakenelektrode mit Trompetenventil, <b>450mm</b> Ø 5.0mm monopolar J-hook electrode with trumpet valve, <b>450mm</b>	
<b>EE-001-042</b>	Ø 5.0mm monopolare 90° Hakenelektrode mit Trompetenventil, <b>330mm</b> Ø 5.0mm monopolar 90° hook electrode with trumpet valve, <b>330mm</b>	
<b>EE-001-052</b>	Ø 5.0mm monopolare 90° Hakenelektrode mit Trompetenventil, <b>450mm</b> Ø 5.0mm monopolar 90° hook electrode with trumpet valve, <b>450mm</b>	
<b>EE-001-045</b>	Ø 5.0mm monopolare Spatelektrode mit Trompetenventil, <b>330mm</b> Ø 5.0mm monopolar spatula electrode with trumpet valve, <b>330mm</b>	
<b>EE-001-055</b>	Ø 5.0mm monopolare Spatelektrode mit Trompetenventil, <b>450mm</b> Ø 5.0mm monopolar spatula electrode with trumpet valve, <b>450mm</b>	
<b>EE-001-041</b>	Ø 5.0mm monopolare Nadelelektrode mit Trompetenventil, <b>330mm</b> Ø 5.0mm monopolar needle electrode with trumpet valve, <b>330mm</b>	
<b>EE-001-051</b>	Ø 5.0mm monopolare Nadelelektrode mit Trompetenventil, <b>450mm</b> Ø 5.0mm monopolar needle electrode with trumpet valve, <b>450mm</b>	



**Bestell-Nr.**  
**Ordering no.**





<b>EE-002-000</b>	Elektrodengriff mit Schaft für auswechselbare Elektrodenspitzen, 320mm <i>Electrode handle with sheath for changeable electrode tips, 320mm</i>
<b>EE-002-010</b>	Elektrodengriff mit Schaft für auswechselbare Elektrodenspitzen, 400mm <i>Electrode handle with sheath for changeable electrode tips, 400mm</i>
<b>EE-002-011</b>	Elektrodengriff mit Schaft für auswechselbare Elektrodenspitzen, 450mm <i>Electrode handle with sheath for changeable electrode tips, 450mm</i>

**Bestell-Nr.**  
**Ordering no.**

<b>EE-002-001</b>	Elektrodenspitze J-Haken <i>Electrode tip J-hook</i>	
<b>EE-002-002</b>	Elektrodenspitze 90° Haken <i>Electrode tip 90° hook</i>	
<b>EE-002-003</b>	Elektrodenspitze Spatel <i>Electrode tip spatula</i>	
<b>EE-002-004</b>	Elektrodenspitze Nadel <i>Electrode tip needle</i>	
<b>EE-002-005</b>	Elektrodenspitze Kugel <i>Electrode tip ball</i>	
<b>EE-002-006</b>	Elektrodenspitze Messer <i>Electrode tip knife</i>	







**Bestell-Nr.**  
**Ordering no.**

<b>EE-005-006</b>	Ø 5.0mm monopolare Keramik-Knopfelektrode, 360mm Ø 5.0mm monopolar ceramic button electrode, 360mm	
<b>EE-005-005</b>	Ø 5.0mm monopolare Keramik-Spatelektrode, 360mm Ø 5.0mm monopolar ceramic spatula electrode, 360mm	
<b>EE-005-003</b>	Ø 5.0mm monopolare Keramik-J-Hakenelektrode, 360mm Ø 5.0mm monopolar ceramic J-hook electrode, 360mm	
<b>EE-005-002</b>	Ø 5.0mm monopolare Keramik-Hakenelektrode 90°, 360mm Ø 5.0mm monopolar ceramic hook electrode 90°, 360mm	
<b>EE-005-001</b>	Ø 5.0mm monopolare Keramik-Nadelelektrode, 360mm Ø 5.0mm monopolar ceramic needle electrode, 360mm	



**Bestell-Nr.**  
**Ordering no.**

<b>EE-005-026</b>	Ø 5.0mm monopolare Keramik-Knopfelektrode mit LL-Adapter, 360mm Ø 5.0mm monopolar ceramic button electrode with LL adapter, 360mm	
<b>EE-005-025</b>	Ø 5.0mm monopolare Keramik-Spatelektrode mit LL-Adapter, 360mm Ø 5.0mm monopolar ceramic spatula electrode with LL adapter, 360mm	
<b>EE-005-023</b>	Ø 5.0mm monopolare Keramik-J-Hakenelektrode mit LL-Adapter, 360mm Ø 5.0mm monopolar ceramic J-hook electrode with LL adapter, 360mm	
<b>EE-005-022</b>	Ø 5.0mm monopolare Keramik-Hakenelektrode 90° mit LL-Adapter, 360mm Ø 5.0mm monopolar ceramic hook electrode 90° with LL adapter, 360mm	
<b>EE-005-021</b>	Ø 5.0mm monopolare Keramik-Nadelelektrode mit LL-Adapter, 360mm Ø 5.0mm monopolar ceramic needle electrode with LL adapter, 360mm	

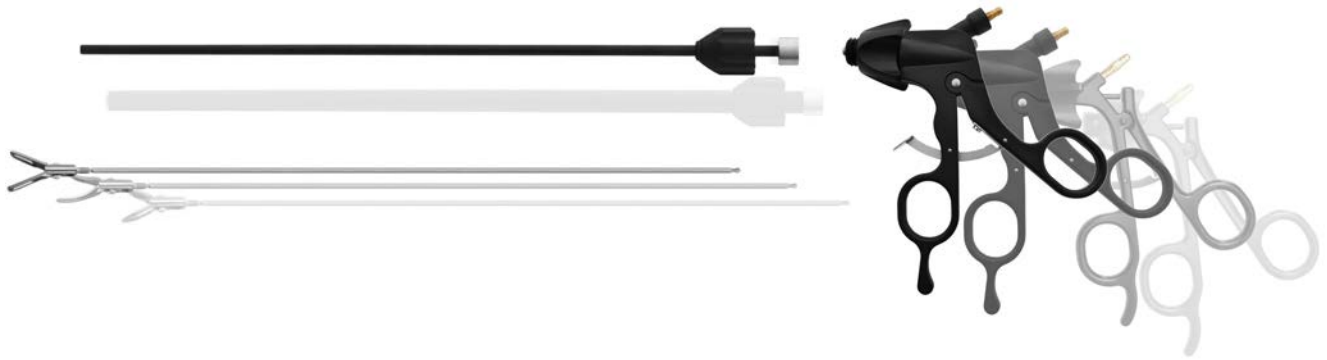

**Bestell-Nr.**  
**Ordering no.**

- |                   |  |
|-------------------|--|
| <b>EC-001-003</b> | Ø 5mm isolierter Schaft für modulares System, 330mm<br>Ø 5mm insulated shaft for modular system, 330mm |
| <b>EC-001-005</b> | Ø 5mm isolierter Schaft für modulares System, 450mm<br>Ø 5mm insulated shaft for modular system, 450mm |



**Bestell-Nr.**  
**Ordering no.**

- |                   |  |
|-------------------|--|
| <b>EC-001-004</b> | Ø 10mm isolierter Schaft für modulares System, 330mm<br>Ø 10mm insulated shaft for modular system, 330mm |
| <b>EC-001-006</b> | Ø 10mm isolierter Schaft für modulares System, 450mm<br>Ø 10mm insulated shaft for modular system, 450mm |

**Hinweis:** Alle Instrumenteneinsätze und Schäfte können mit den nachfolgenden Griffen kombiniert werden. Bitte kontaktieren Sie uns.

**Advice:** All instrument inserts and sheaths can be combined with the following handles. Please kindly contact us.





**Bestell-Nr.**  
**Ordering no.**

**EC-001-001**

STEMA ergonomischer Laparoskopie  
Handgriff mit HF-Anschluss  
*STEMA ergonomic laparoscopic handle  
with HF-connection*



**Bestell-Nr.**  
**Ordering no.**

**ED-001-001**

STEMA ergonomischer Laparoskopie  
Handgriff mit Sperre  
*STEMA ergonomic laparoscopic handle  
with ratchet*



**Bestell-Nr.**  
**Ordering no.**

**EC-001-002**

Standard Laparoskopie Handgriff mit  
HF-Anschluss, isoliert, ohne Sperre  
*Standard laparoscopic handle with  
HF-connection, insulated, without ratchet*



**Bestell-Nr.**  
**Ordering no.**

**ED-001-005**

Standard Laparoskopie Handgriff mit  
HF-Anschluss, isoliert, mit Sperre  
*Standard laparoscopic handle with  
HF-connection, insulated, with ratchet*



**Bestell-Nr.**  
**Ordering no.**

**ED-001-003**

Standard Laparoskopie Handgriff, nicht  
isoliert, ohne Sperre  
*Standard laparoscopic handle, not  
insulated, without ratchet*



**Bestell-Nr.**  
**Ordering no.**

**ED-001-002**

Standard Laparoskopie Handgriff, nicht  
isoliert, mit Sperre  
*Standard laparoscopic handle, not  
insulated, with ratchet*



**Bestell-Nr.**  
**Ordering no.**

**ED-001-006**

Standard Laparoskopie Handgriff,  
isoliert, mit französischer Sperre  
*Standard laparoscopic handle,  
insulated, with french ratchet*



**Bestell-Nr.**  
**Ordering no.**

**ED-001-009**

STEMA ergonomischer Laparoskopie  
Handgriff mit französischer Sperre  
*STEMA ergonomic laparoscopic  
handle with french ratchet*



**Bestell-Nr.**  
**Ordering no.**

**ED-001-004**









Standard Laparoskopie Handgriff mit  
Feder, nicht isoliert  
*Standard laparoscopic handle with  
spring, not insulated*



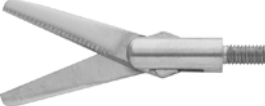

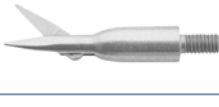
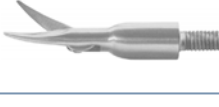
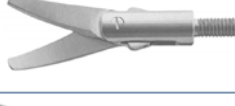









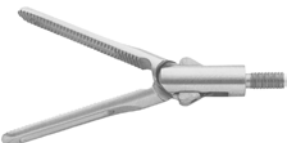

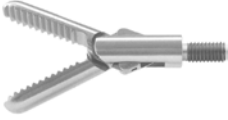



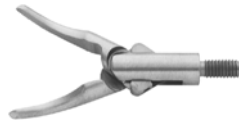

**Bestell-Nr.**  
**Ordering no.**





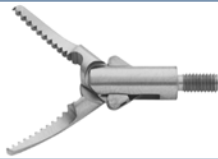
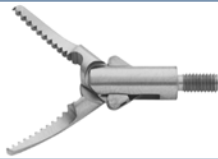

**ED-001-007**

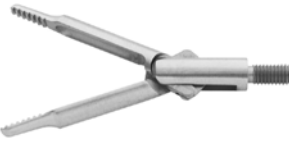
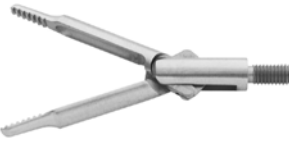



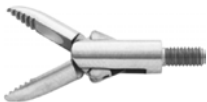

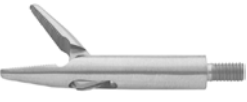

Axialer Ringgriff für modulares System,  
mit Sperre  
*Axial ring handle used for modular  
system, with ratchet*

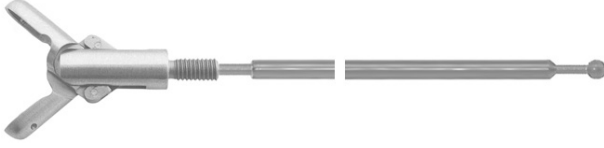
5mm Einsatz allein Insert only			5mm Instrument komplett Instrument complete		
					
330mm	450mm	Maul Tip	Bezeichnung Description	330mm	450mm
EC-005-041	EC-005-042		<b>Schere</b> , gerade, doppelbeweglich <b>Scissors</b> , straight, double action	EC-005-043	EC-005-044
EC-005-371	EC-005-372		<b>Schere</b> , gerade, gezahnt, doppelbeweglich <b>Scissors</b> , straight, serrated, double action	EC-005-373	EC-005-374
EC-005-021	EC-005-022		<b>Peritonealschere</b> , gezahnt, einfachbeweglich <b>Peritoneal scissors</b> , serrated, single action	EC-005-023	EC-005-024
EC-005-031	EC-005-032		<b>Hakenschere</b> , einfachbeweglich <b>Hook scissors</b> , single action	EC-005-033	EC-005-034
EC-005-051	EC-005-052		<b>Mikroschere</b> , gerade, einfachweglich <b>Micro scissors</b> , straight, single action	EC-005-053	EC-005-054
EC-005-351	EC-005-352		<b>Mikroschere</b> , gebogen, sehr fein, einfachweglich <b>Micro scissors</b> , curved, very delicate, double action	EC-005-353	EC-005-354
EC-005-001	EC-005-002		<b>Metzenbaumschere</b> , gebogen, kurz, doppelbeweglich <b>Metzenbaum scissors</b> , curved, short, double action	EC-005-003	EC-005-004
EC-005-011	EC-005-012		<b>Metzenbaumschere</b> , gebogen, lang, doppelbeweglich <b>Metzenbaum scissors</b> , curved, long, double action	EC-005-013	EC-005-014
EC-005-061	EC-005-062		<b>Metzenbaumschere</b> , gebogen, gezahnt, doppelbeweglich <b>Metzenbaum scissors</b> , curved, serrated, double action	EC-005-063	EC-005-064
EC-005-311	EC-005-312		<b>Mini-Metzenbaumschere</b> , gebo- gen, 5 auf 4mm, doppelbeweglich <b>Mini-Metzenbaum scissors</b> , curved, 5 to 4mm, double action	EC-005-313	EC-005-314













5mm		Einsatz allein Insert only		5mm		Instrument komplett Instrument complete	
330mm	450mm	Maul Tip		Bezeichnung Description		330mm	450mm
							
EC-005-111	EC-005-112			Präparier- und Faßzange, gefenestert, doppelbeweglich <b>Dissecting and grasping forceps, fenestrated, double action</b>	EC-005-113	EC-005-114	
EC-005-391	EC-005-392			Präparier- und Faßzange, gefenestert, 25mm lang, doppelbeweglich <b>Dissecting and grasping forceps, fenestrated, 25mm long, double action</b>	EC-005-393	EC-005-394	
EC-005-151	EC-005-152			Präparier- und Faßzange, doppelbeweglich <b>Dissecting and grasping forceps, double action</b>	EC-005-153	EC-005-154	
EC-005-161	EC-005-162			Präparier- und Faßzange, stumpf, doppelbeweglich <b>Dissecting and grasping forceps, blunt, double action</b>	EC-005-163	EC-005-164	
EC-005-211	EC-005-212			Präparier- und Faßzange, stumpf mit Löffel, doppelbeweglich <b>Dissecting and grasping forceps, blunt with spoon, double action</b>	EC-005-213	EC-005-214	
EC-005-171	EC-005-172			Mixer Präparier- und Faßzange, doppelbeweglich <b>Mixer dissecting and grasping forceps, double action</b>	EC-005-173	EC-005-174	
EC-005-361	EC-005-362			Mixer Präparier- und Faßzange, lang und dünn, doppelbeweglich <b>Mixer dissecting and grasping forceps, long and thin, double action</b>	EC-005-363	EC-005-364	
EC-005-421	EC-005-422			90° Mixer Präparier- und Faßzange, doppelbeweglich <b>90° Mixer dissecting and grasping forceps, double action</b>	EC-005-423	EC-005-424	



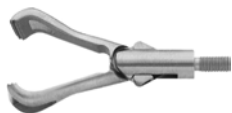



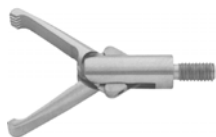





5mm			Einsatz allein Insert only	5mm			Instrument komplett Instrument complete
330mm	450mm	Maul Tip		Bezeichnung Description	330mm	450mm	
EC-005-181	EC-005-182			<b>Kelly</b> Präparier- und Faßzange, doppelbeweglich <b>Kelly</b> dissecting and grasping forceps, double action	EC-005-183	EC-005-184	
EC-005-431	EC-005-432			<b>Präparier- und Faßzange</b> , atraumatisch, gefenestert, gebogen, doppelbeweglich <b>Dissecting and grasping forceps</b> , atraumatic, fenestrated, curved, double action	EC-005-433	EC-005-434	
EC-005-121	EC-005-122			<b>Maryland</b> Dissektionszange, doppelbeweglich <b>Maryland</b> dissecting forceps, double action	EC-005-123	EC-005-124	
EC-005-411	EC-005-412			<b>Maryland</b> Dissektionszange, kurz, doppelbeweglich <b>Maryland</b> dissecting forceps, short, double action	EC-005-413	EC-005-414	
EC-005-271	EC-005-272			<b>Maryland</b> Dissektionszange, kreuzgezahnt, doppelbeweglich <b>Maryland</b> dissecting forceps, cross serrated, double action	EC-005-273	EC-005-274	
EC-005-131	EC-005-132			<b>Dolphin</b> Dissektionszange, doppelbeweglich <b>Dolphin</b> dissecting forceps, double action	EC-005-133	EC-005-134	
EC-005-141	EC-005-142			<b>Dolphin</b> Dissektionszange, lang, doppelbeweglich <b>Dolphin</b> dissecting forceps, long, double action	EC-005-143	EC-005-144	









5mm Einsatz allein Insert only			5mm Instrument komplett Instrument complete		
330mm	450mm	Maul Tip	Bezeichnung Description	330mm	450mm
					
EC-005-231	EC-005-232		<b>Slim</b> Dissektionszange, einfachbeweglich <b>Slim</b> dissecting forceps, single action	EC-005-233	EC-005-234
EC-005-241	EC-005-242		<b>Dissektionszange</b> , spitz mit Löffel, doppelbeweglich <b>Dissecting forceps</b> , pointed with spoon, double action	EC-005-243	EC-005-244
EC-005-301	EC-005-302		<b>Reddick-Olsen</b> Dissektionszange, doppelbeweglich <b>Reddick-Olsen</b> dissecting forceps, double action	EC-005-303	EC-005-304
EC-005-321	EC-005-322		<b>Dissektionszange</b> , gezahnt, stark gebogen, einfachbeweglich <b>Dissecting forceps</b> , serrated, strong curved, single action	EC-005-323	EC-005-324
EC-005-331	EC-005-332		<b>Dissektionszange</b> , fein gezahnt, gerade, einfachbeweglich <b>Dissecting forceps</b> , fine serrated, straight, single action	EC-005-333	EC-005-334
EC-005-341	EC-005-342		<b>Dissektionszange</b> , fein gezahnt, leicht gebogen, einfachbeweglich <b>Dissecting forceps</b> , fine serrated, slightly curved, single action	EC-005-343	EC-005-344



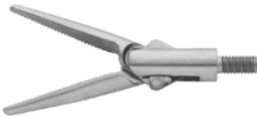

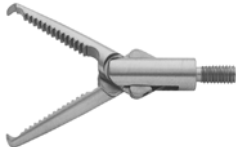

5mm			5mm		
Einsatz allein Insert only			Instrument komplett Instrument complete		
330mm	450mm	Maul Tip	Bezeichnung Description	330mm	450mm
					
<b>EC-005-191</b>	<b>EC-005-192</b>		<b>Löffel</b> Probeexzisionszange, doppelbeweglich <b>Spoon</b> biopsy forceps, double action	<b>EC-005-193</b>	<b>EC-005-194</b>
<b>EC-005-201</b>	<b>EC-005-202</b>		<b>Löffel</b> Probeexzisionszange, mit Dorn, doppelbeweglich <b>Spoon</b> biopsy forceps, with spike, double action	<b>EC-005-203</b>	<b>EC-005-204</b>
<b>EC-005-251</b>	<b>EC-005-252</b>		<b>Löffel</b> Probeexzisionszange, einfachbeweglich <b>Spoon</b> biopsy forceps, single action	<b>EC-005-253</b>	<b>EC-005-254</b>
<b>EC-005-261</b>	<b>EC-005-262</b>		<b>Löffel</b> Probeexzisionszange, mit Dorn, einfachbeweglich <b>Spoon</b> biopsy forceps, with spike, single action	<b>EC-005-263</b>	<b>EC-005-264</b>
<b>EC-005-221</b>	<b>EC-005-222</b>		<b>Blakesly</b> Probeexzisionszange, doppelbeweglich <b>Blakesly</b> biopsy forceps, double action	<b>EC-005-223</b>	<b>EC-005-224</b>
<b>EC-005-401</b>	<b>EC-005-402</b>		<b>Mikrobiopsielöffel</b> , einfachbeweglich <b>Micro biopsy forceps</b> , single action	<b>EC-005-403</b>	<b>EC-005-404</b>





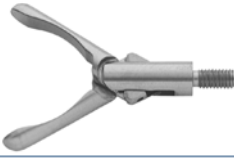
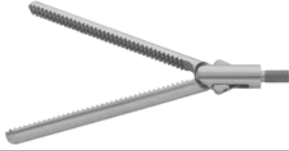







5mm		Einsatz allein Insert only		5mm		Instrument komplett Instrument complete	
330mm	450mm	Maul Tip		Bezeichnung Description		330mm	450mm
							
ED-005-011	ED-005-012			Fundus Faszange, doppelbeweglich Fundus grasping forceps, double action		ED-005-013	ED-005-014
ED-005-021	ED-005-022			Cobra Faszange, 2 x 3 Zähne, doppelbeweglich Cobra grasping forceps, 2 x 3 teeth, double action		ED-005-023	ED-005-024
ED-005-041	ED-005-042			Endo-Clinch Faszange, gefenestert, doppelbeweglich Endo-Clinch grasping forceps, fenestrated, double action		ED-005-043	ED-005-044
ED-005-051	ED-005-052			Babcock Faszange, doppelbeweglich Babcock grasping forceps, double action		ED-005-053	ED-005-054
ED-005-371	ED-005-372			Babcock Faszange, kurz, doppelbeweglich Babcock grasping forceps, short, double action		ED-005-373	ED-005-374
ED-005-081	ED-005-082			DeBakey Faszange, doppelbeweglich DeBakey grasping forceps, double action		ED-005-083	ED-005-084
ED-005-331	ED-005-332			DeBakey-Maryland atraumatische Faszange, doppelbeweglich DeBakey-Maryland atraumatic grasping forceps, double action		ED-005-333	ED-005-334
ED-005-101	ED-005-102			Allis Faszange, doppelbeweglich Allis grasping forceps, double action		ED-005-103	ED-005-104
ED-005-361	ED-005-362			Allis Faszange, atraumatisch, 3 x 4 Zähne, doppelbeweglich Allis grasping forceps, atraumatic, 3 x 4 teeth, double action		ED-005-363	ED-005-364
ED-005-191	ED-005-192			Allis Faszange, einfachbeweglich Allis grasping forceps, single action		ED-005-193	ED-005-194





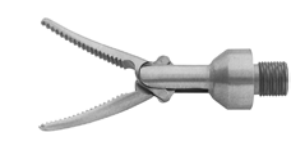





5mm Einsatz allein Insert only			5mm Instrument komplett Instrument complete		
330mm	450mm	Maul Tip	Bezeichnung Description	330mm	450mm
			<b>Alligator</b> Fass- und Probe- exzisionszange, doppelbeweglich <i>Alligator grasping and biopsy forceps, double action</i>		
<b>ED-005-031</b>	<b>ED-005-032</b>		<b>Alligator</b> Fasszange, doppelbeweglich <i>Alligator grasping forceps, double action</i>	<b>ED-005-033</b>	<b>ED-005-034</b>
<b>ED-005-201</b>	<b>ED-005-202</b>		<b>Alligator</b> Fasszange, einfachbeweglich <i>Alligator grasping forceps, single action</i>	<b>ED-005-383</b>	<b>ED-005-384</b>
<b>ED-005-311</b>	<b>ED-005-312</b>		<b>Duckbill</b> Fasszange, kurz, gefenstert, einfachbeweglich <i>Duckbill grasping forceps, short, fenestrated, single action</i>	<b>ED-005-313</b>	<b>ED-005-314</b>
<b>ED-005-171</b>	<b>ED-005-172</b>		<b>Duckbill</b> Fasszange, 22mm, gefenstert, einfachbeweglich <i>Duckbill grasping forceps, 22mm, fenestrated, single action</i>	<b>ED-005-173</b>	<b>ED-005-174</b>
<b>ED-005-321</b>	<b>ED-005-322</b>		<b>Duckbill</b> Fasszange, 38mm, gefenstert, einfachbeweglich <i>Duckbill grasping forceps, 38mm, fenestrated, single action</i>	<b>ED-005-323</b>	<b>ED-005-324</b>
<b>ED-005-431</b>	<b>ED-005-432</b>		<b>Bowel</b> Fasszange, gefenstert, doppelbeweglich <i>Bowel grasping forceps, fenestrated, double action</i>	<b>ED-005-433</b>	<b>ED-005-434</b>
<b>ED-005-061</b>	<b>ED-005-062</b>		<b>Wave</b> Fasszange, atraumatisch, doppelbeweglich <i>Wave grasping forceps, atraumatic, double action</i>	<b>ED-005-063</b>	<b>ED-005-064</b>
<b>ED-005-181</b>	<b>ED-005-182</b>		<b>Wave</b> Fasszange, atraumatisch, einfachbeweglich <i>Wave grasping forceps, atraumatic, single action</i>	<b>ED-005-183</b>	<b>ED-005-184</b>

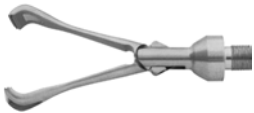
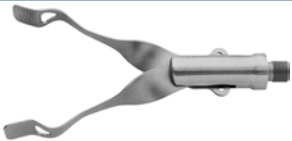











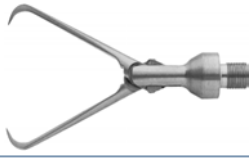

5mm		Einsatz allein Insert only		5mm		Instrument komplett Instrument complete	
330mm	450mm	Maul Tip	Bezeichnung Description	330mm	450mm		
							
<b>ED-005-351</b>	<b>ED-005-352</b>		<b>Glassmann</b> Fasszange, atraumatisch, doppelbeweglich <b>Glassmann</b> grasping forceps, atraumatic, double action	<b>ED-005-353</b>	<b>ED-005-354</b>		
<b>ED-005-071</b>	<b>ED-005-072</b>		<b>Slim</b> Fasszange, atraumatisch, doppelbeweglich <b>Slim</b> grasping forceps, atraumatic, double action	<b>ED-005-073</b>	<b>ED-005-074</b>		
<b>ED-005-421</b>	<b>ED-005-422</b>		<b>Tenaculum</b> Fasszange, doppelbeweglich <b>Tenaculum</b> grasping forceps, double action	<b>ED-005-423</b>	<b>ED-005-424</b>		
<b>ED-005-211</b>	<b>ED-005-212</b>		<b>Fasszange</b> , 1x2 Zähne, doppelbeweglich <b>Grasping forceps</b> , 1x2 teeth, double action	<b>ED-005-213</b>	<b>ED-005-214</b>		
<b>ED-005-281</b>	<b>ED-005-282</b>		<b>Fasszange</b> , gewellt, 2x3 Zähne, einfachbeweglich <b>Grasping forceps</b> , wavy, 2x3 teeth, single action	<b>ED-005-283</b>	<b>ED-005-284</b>		
<b>ED-005-341</b>	<b>ED-005-342</b>		<b>Fasszange</b> , scharf, atraumatisch, einfachbeweglich <b>Grasping forceps</b> , sharp, atraumatic, single action	<b>ED-005-343</b>	<b>ED-005-344</b>		
<b>ED-005-161</b>	<b>ED-005-162</b>		<b>Krallengreifer</b> , einfachbeweglich <b>Claw forceps</b> , single action	<b>ED-005-163</b>	<b>EC-005-164</b>		
<b>ED-005-391</b>	<b>ED-005-392</b>		<b>Krallengreifer</b> , doppelbeweglich <b>Claw forceps</b> , double action	<b>ED-005-393</b>	<b>ED-005-394</b>		

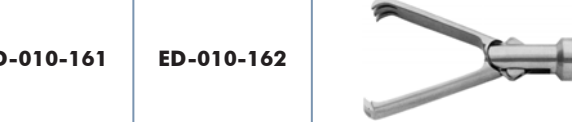
5mm			5mm		
Einsatz allein Insert only			Instrument komplett Instrument complete		
330mm	450mm	Maul Tip	Bezeichnung Description	330mm	450mm
					
<b>ED-005-091</b>	<b>ED-005-092</b>		<b>Bowel</b> Darmfasszange, doppelbeweglich <b>Bowel</b> intestinal grasping forceps, double action	<b>ED-005-093</b>	<b>ED-005-094</b>
<b>ED-005-111</b>	<b>ED-005-112</b>		<b>Bowel</b> Darmfasszange, doppelbeweglich <b>Bowel</b> intestinal grasping forceps, double action	<b>ED-005-113</b>	<b>ED-005-114</b>
<b>ED-005-151</b>	<b>ED-005-152</b>		<b>Dorsey</b> Darmfasszange, doppelbeweglich <b>Dorsey</b> intestinal grasping forceps, double action	<b>ED-005-153</b>	<b>ED-005-154</b>
<b>ED-005-401</b>	<b>ED-005-402</b>		<b>Satinsky</b> Klemme, 38mm, atraumatisch, einfachbeweglich <b>Satinsky</b> clamp, 38mm, atraumatic, single action	<b>ED-005-403</b>	<b>ED-005-404</b>
<b>ED-005-411</b>	<b>ED-005-412</b>		<b>Satinsky</b> Klemme, 60mm, atraumatisch einfachbeweglich <b>Satinsky</b> clamp, 60mm, atraumatic, single action	<b>ED-005-413</b>	<b>ED-005-414</b>
<b>ED-005-261</b>	<b>ED-005-262</b>		<b>Punch</b> durchschneidend, einfachbeweglich <b>Punch</b> cutting through, single action	<b>ED-005-263</b>	<b>ED-005-264</b>
<b>ED-005-451</b>	<b>ED-005-452</b>		<b>Punch</b> durchschneidend, hakenförmig, einfachbeweglich <b>Punch</b> cutting through, hook shape, single action	<b>ED-005-453</b>	<b>ED-005-454</b>

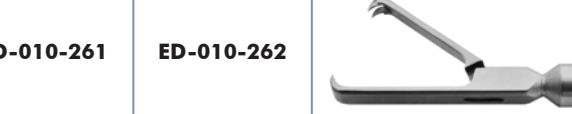
10mm Einsatz allein Insert only			10mm Instrument komplett Instrument complete		
					
330mm	450mm	Maul Tip	Bezeichnung Description	330mm	450mm
EC-010-011	EC-010-012		Schere, gebogen, doppelbeweglich Scissors, curved, double action	EC-010-013	EC-010-014
EC-010-021	EC-010-022		Schere, gerade, einfachbeweglich Scissors, straight, single action	EC-010-023	EC-010-024

10mm			Einsatz allein Insert only	10mm			Instrument komplett Instrument complete
330mm	450mm	Maul Tip	Bezeichnung Description	330mm	450mm		
EC-010-171	EC-010-172		<b>Mixer</b> Präparier- und Fasszange, doppelbeweglich <b>Mixer</b> dissecting and grasping forceps, double action	EC-010-173	EC-010-174		
EC-010-201	EC-010-202		<b>Mixer</b> Präparier- und Fasszange, 45° gewinkelt, doppelbeweglich <b>Mixer</b> dissecting and grasping forceps, 45° angled, double action	EC-010-203	EC-010-204		
EC-010-121	EC-010-122		<b>Maryland</b> Dissektionszange, doppelbeweglich <b>Maryland</b> dissecting forceps, double action	EC-010-123	EC-010-124		
EC-010-211	EC-010-212		<b>Maryland</b> Dissektionszange, kreuzgezahnt, doppelbeweglich <b>Maryland</b> dissecting forceps, cross serrated, double action	EC-010-213	EC-010-214		
EC-010-141	EC-010-142		<b>Dolphin</b> Dissektionszange, lang, doppelbeweglich <b>Dolphin</b> dissecting forceps, long, double action	EC-010-143	EC-010-144		
EC-010-191	EC-010-192		<b>Löffel</b> Probeexzisionszange, einfachbeweglich <b>Spoon</b> biopsy forceps, single action	EC-010-193	EC-010-194		

10mm		Einsatz allein Insert only		10mm		Instrument komplett Instrument complete	
330mm	450mm	Maul Tip		Bezeichnung Description		330mm	450mm
							
ED-010-051	ED-010-052			<b>Babcock</b> Fasszange, doppelbeweglich <b>Babcock</b> grasping forceps, double action		ED-010-053	ED-010-054
ED-010-301	ED-010-302			<b>Babcock</b> Fasszange, federnd, flexibel, doppelbeweglich <b>Babcock</b> grasping forceps, spring tension, flexible, double action		ED-010-303	ED-010-304
ED-010-081	ED-010-082			<b>DeBakey</b> Fasszange, doppelbeweglich <b>DeBakey</b> grasping forceps, double action		ED-010-083	ED-010-084
ED-010-341	ED-010-342			<b>DeBakey</b> Fasszange, 60mm, doppelbeweglich <b>Babcock</b> grasping forceps, 60mm, double action		ED-010-343	ED-010-344
ED-010-101	ED-010-102			<b>Allis</b> Fasszange, doppelbeweglich <b>Allis</b> grasping forceps, double action		ED-010-103	ED-010-104
ED-010-231	ED-010-232			<b>Johann</b> Fasszange, gefenstert, einfachbeweglich <b>Johann</b> grasping forceps, fenestrated, single action		ED-010-233	ED-010-234
ED-010-241	ED-010-242			<b>Pennington</b> Fasszange, doppelbeweglich <b>Pennington</b> grasping forceps, double action		ED-010-243	ED-010-244
ED-010-251	ED-010-252			<b>Duval</b> Fasszange, doppelbeweglich <b>Duval</b> grasping forceps, double action		ED-010-253	ED-010-254
ED-010-311	ED-010-312			<b>Kocher</b> Fasszange, axiale Zahnung, 40mm Maullänge, doppelbeweglich <b>Kocher</b> grasping forceps, axial serration, 40mm tip length, double action		ED-010-313	ED-010-314
ED-010-321	ED-010-322			<b>Kocher</b> Fasszange, axiale Zahnung, 60mm Maullänge, doppelbeweglich <b>Kocher</b> grasping forceps, axial serration, 60mm tip length, double action		ED-010-323	ED-010-324

10mm			Einsatz allein Insert only	10mm			Instrument komplett Instrument complete
330mm	450mm	Maul Tip		Bezeichnung Description	330mm	450mm	
ED-010-331	ED-010-332			<b>Alligator</b> Faszange, doppelbeweglich <b>Alligator</b> grasping forceps, double action	ED-010-333	ED-010-334	
ED-010-221	ED-010-222			<b>Tenaculum</b> Faszange, doppelbeweglich <b>Tenaculum</b> grasping forceps, double action	ED-010-223	ED-010-224	
ED-010-351	ED-010-352			<b>Anvil</b> Faszange, doppelbeweglich <b>Anvil</b> grasping forceps, double action	ED-010-353	ED-010-354	
ED-010-161	ED-010-162			<b>Krallengreifer,</b> doppelbeweglich <b>Claw</b> grasping forceps, double action	ED-010-163	ED-010-164	
ED-010-261	ED-010-262			<b>Krallengreifer,</b> einfachbeweglich <b>Claw</b> grasping forceps, single action	ED-010-263	ED-010-264	
ED-010-011	ED-010-012			<b>Faszange,</b> doppelbeweglich <b>Grasping forceps,</b> double action	ED-010-013	ED-010-014	
ED-010-281	ED-010-282			<b>Faszange,</b> atraumatisch, gebogen, doppelbeweglich <b>Grasping forceps,</b> atraumatic, curved, double action	ED-010-283	ED-010-284	
ED-010-291	ED-010-292			<b>Faszange,</b> atraumatisch, gerade, doppelbeweglich <b>Grasping forceps,</b> atraumatic, straight, double action	ED-010-293	ED-010-294	





**Bestell-Nr.  
Ordering no.**

**ED-010-053-A**

Ø 10mm Babcock Faßzange, doppelbeweglich, Griff mit Zugfeder, 330mm  
Ø 10mm Babcock grasping forceps, double action, handle with tension spring, 330mm



**ED-010-083-A**

Ø 10mm DeBakey Faßzange, doppelbeweglich, Griff mit Zugfeder, 330mm  
Ø 10mm DeBakey grasping forceps, double action, handle with tension spring, 330mm



**ED-010-103-A**

Ø 10mm Allis Faßzange, doppelbeweglich, Griff mit Zugfeder, 330mm  
Ø 10mm Allis grasping forceps, double action, handle with tension spring, 330mm



**ED-010-263-A**

Ø 10mm Krallengreifer, einfachbeweglich, Griff mit Zugfeder, 330mm  
Ø 10mm claw grasping forceps, single action, handle with tension spring, 330mm





Bestell-Nr. Ordering no.		
<b>ED-030-001</b>	Ø 5mm T-förmige Fasszange, Federgriff, Arbeitslänge 330mm Ø 5mm T-shaped grasping forceps, U-spring handle, working length 330mm	
<b>ED-030-002</b>	Ø 5mm Eileiter Fasszange, Federgriff, Arbeitslänge 330mm Ø 5mm tube grasping forceps, U-spring handle, working length 330mm	
<b>ED-030-003</b>	Ø 5mm Mauszahn Fasszange, Federgriff, Arbeitslänge 330mm Ø 5mm rat tooth grasping forceps, U-spring handle, working length 330mm	
<b>ED-030-004</b>	Ø 5mm Darmfasszange, Federgriff, Arbeitslänge 330mm Ø 5mm bowel grasping forceps, U-spring handle, working length 330mm	
<b>ED-030-005</b>	Ø 5mm Fasszange, rund, Federgriff, Arbeitslänge 330mm Ø 5mm grasping forceps, round, U-spring handle, working length 330mm	
<b>ED-030-006</b>	Ø 5mm atraumatische Fasszange, Federgriff, Arbeitslänge 330mm Ø 5mm atraumatic grasping forceps, U-spring handle, working length 330mm	
<b>ED-030-007</b>	Ø 5mm Fasszange 1x2 Zähne, Federgriff, Arbeitslänge 330mm Ø 5mm grasping forceps 1x2 teeth, U-spring handle, working length 330mm	
<b>ED-030-008</b>	Ø 5mm atraumatische Fasszange, gefenstert, Federgriff, Arbeitslänge 330mm Ø 5mm atraumatic grasping forceps, fenestrated, U-spring handle, working length 330mm	
<b>ED-030-009</b>	Ø 5mm Gewebefasszange, Federgriff, Arbeitslänge 330mm Ø 5mm tissue grasping forceps, U-spring handle, working length 330mm	
<b>ED-030-010</b>	Ø 5mm atraumatische Fasszange, Federgriff, Arbeitslänge 330mm Ø 5mm bowel grasping forceps, U-spring handle, working length 330mm	
<b>ED-030-011</b>	Ø 5mm atraumatische Fasszange, lang, Federgriff, Arbeitslänge 330mm Ø 5mm bowel grasping forceps, long, U-spring handle, working length 330mm	



**Bestell-Nr.  
Ordering no.**

<b>EG-003-001</b>	Ø 5mm axialer Nadelhalter, gerade, TC-Einsatz, Arbeitslänge 330mm Ø 5mm axial needleholder, straight, TC-insert, working length 330mm	
<b>EG-003-001-45</b>	Ø 5mm axialer Nadelhalter, gerade, TC-Einsatz, Arbeitslänge 450mm Ø 5mm axial needleholder, straight, TC-insert, working length 450mm	
<b>EG-003-002</b>	Ø 5mm axialer Nadelhalter, links gebogen, TC-Einsatz, Arbeitslänge 330mm Ø 5mm axial needleholder, curved left, TC-insert, working length 330mm	
<b>EG-003-002-45</b>	Ø 5mm axialer Nadelhalter, links gebogen, TC-Einsatz, Arbeitslänge 450mm Ø 5mm axial needleholder, curved left, TC-insert, working length 450mm	
<b>EG-003-003</b>	Ø 5mm axialer Nadelhalter, rechts gebogen, TC-Einsatz, Arbeitslänge 330mm Ø 5mm axial needleholder, curved right, TC-insert, working length 330mm	
<b>EG-003-003-45</b>	Ø 5mm axialer Nadelhalter, rechts gebogen, TC-Einsatz, Arbeitslänge 450mm Ø 5mm axial needleholder, curved right, TC-insert, working length 450mm	
<b>EG-003-004</b>	Ø 5mm axialer Nadelhalter, gerade, selbstjustierend, diamantbeschichtet, AL 330mm Ø 5mm axial needleholder, straight, selfadjusting, diamond coated, WL 330mm	
<b>EG-003-004-45</b>	Ø 5mm axialer Nadelhalter, gerade, selbstjustierend, diamantbeschichtet, AL 330mm Ø 5mm axial needleholder, straight, selfadjusting, diamond coated, WL 330mm	











**Bestell-Nr.  
Ordering no.**

<b>EG-003-021</b>	Ø 5mm Nadelhalter, gerade, Ringgriff, TC-Einsatz, Arbeitslänge 330mm Ø 5mm needleholder, straight, ring handle, TC-insert, working length 330mm	
<b>EG-003-021-45</b>	Ø 5mm Nadelhalter, gerade, Ringgriff, TC-Einsatz, Arbeitslänge 450mm Ø 5mm needleholder, straight, ring handle, TC-insert, working length 450mm	
<b>EG-003-022</b>	Ø 5mm Nadelhalter, links gebogen, Ringgriff, TC-Einsatz, Arbeitslänge 330mm Ø 5mm needleholder, curved left, ring handle, TC-insert, working length 330mm	
<b>EG-003-022-45</b>	Ø 5mm Nadelhalter, links gebogen, Ringgriff, TC-Einsatz, Arbeitslänge 450mm Ø 5mm needleholder, curved left, ring handle, TC-insert, working length 450mm	
<b>EG-003-023</b>	Ø 5mm Nadelhalter, rechts gebogen, Ringgriff, TC-Einsatz, Arbeitslänge 330mm Ø 5mm needleholder, curved right, ring handle, TC-insert, working length 330mm	
<b>EG-003-023-45</b>	Ø 5mm Nadelhalter, rechts gebogen, Ringgriff, TC-Einsatz, Arbeitslänge 450mm Ø 5mm needleholder, curved right, ring handle, TC-insert, working length 450mm	
<b>EG-003-024</b>	Ø 5mm Nadelhalter, gerade, selbstjustierend, Ringgriff, diamantbeschichtet, AL 330mm Ø 5mm needleholder, straight, selfadjusting, ring handle, diamond coated, WL 330mm	
<b>EG-003-024-45</b>	Ø 5mm Nadelhalter, gerade, selbstjustierend, Ringgriff, diamantbeschichtet, AL 450mm Ø 5mm needleholder, straight, selfadjusting, ring handle, diamond coated, WL 450mm	











**Bestell-Nr.  
Ordering no.**

<b>EG-003-042</b>	Ø 5mm gewinkelter axialer Nadelhalter, gerade, TC-Einsatz, Arbeitslänge 330mm Ø 5mm angled axial needleholder, straight, TC-insert, working length 330mm	
<b>EG-003-049</b>	Ø 5mm gewinkelter axialer Nadelhalter, gerade, TC-Einsatz, Arbeitslänge 450mm Ø 5mm angled axial needleholder, straight, TC-insert, working length 450mm	
<b>EG-003-043</b>	Ø 5mm gewinkelter axialer Nadelhalter, links gebogen, TC-Einsatz, Arbeitslänge 330mm Ø 5mm angled axial needleholder, curved left, TC-insert, working length 330mm	
<b>EG-003-050</b>	Ø 5mm gewinkelter axialer Nadelhalter, links gebogen, TC-Einsatz, Arbeitslänge 450mm Ø 5mm angled axial needleholder, curved left, TC-insert, working length 450mm	
<b>EG-003-044</b>	Ø 5mm gewinkelter axialer Nadelhalter, rechts gebogen, TC-Einsatz, Arbeitslänge 330mm Ø 5mm angled axial needleholder, curved right, TC-insert, working length 330mm	
<b>EG-003-059</b>	Ø 5mm gewinkelter axialer Nadelhalter, rechts gebogen, TC-Einsatz, Arbeitslänge 450mm Ø 5mm angled axial needleholder, curved right, TC-insert, working length 450mm	
<b>EG-003-045</b>	Ø 5mm gewinkelter axialer Nadelhalter, gerade, selbstjust., diamantbeschichtet, AL 330mm Ø 5mm angled axial needleholder, straight, selfadjusting, diamond coated, WL 330mm	
<b>EG-003-045-1</b>	Ø 5mm gewinkelter axialer Nadelhalter, gerade, selbstjust., diamantbeschichtet, AL 450mm Ø 5mm angled axial needleholder, straight, selfadjusting, diamond coated, WL 450mm	



**Bestell-Nr.  
Ordering no.**

<b>EG-003-051</b>	Ø 5mm axialer Nadelhalter, gerade, TC-Einsatz, Arbeitslänge 330mm Ø 5mm axial needleholder, straight, TC-insert, working length 330mm	
<b>EG-003-055</b>	Ø 5mm axialer Nadelhalter, gerade, TC-Einsatz, Arbeitslänge 450mm Ø 5mm axial needleholder, straight, TC-insert, working length 450mm	
<b>EG-003-052</b>	Ø 5mm axialer Nadelhalter, links gebogen, TC-Einsatz, Arbeitslänge 330mm Ø 5mm axial needleholder, curved left, TC-insert, working length 330mm	
<b>EG-003-056</b>	Ø 5mm axialer Nadelhalter, links gebogen, TC-Einsatz, Arbeitslänge 450mm Ø 5mm axial needleholder, curved left, TC-insert, working length 450mm	
<b>EG-003-053</b>	Ø 5mm axialer Nadelhalter, rechts gebogen, TC-Einsatz, Arbeitslänge 330mm Ø 5mm axial needleholder, curved right, TC-insert, working length 330mm	
<b>EG-003-057</b>	Ø 5mm axialer Nadelhalter, rechts gebogen, TC-Einsatz, Arbeitslänge 450mm Ø 5mm axial needleholder, curved right, TC-insert, working length 450mm	
<b>EG-003-054</b>	Ø 5mm axialer Nadelhalter, gerade, selbstjustierend, diamantbeschichtet, AL 330mm Ø 5mm axial needleholder, straight, selfadjusting, diamond coated, WL 330mm	
<b>EG-003-058</b>	Ø 5mm axialer Nadelhalter, gerade, selbstjustierend, diamantbeschichtet, AL 450mm Ø 5mm axial needleholder, straight, selfadjusting, diamond coated, WL 450mm	



**Bestell-Nr.**  
**Ordering no.**

<b>EG-003-070</b>	<p>Ø 5mm gewinkelter axialer Nadelhalter, gerade, TC-Einsatz, Arbeitslänge 330mm, <b>zerlegbar</b>                  Ø 5mm angled axial needleholder, straight, TC-insert, working length 330mm, <b>detachable</b></p>	
<b>EG-003-071</b>	<p>Ø 5mm gewinkelter axialer Nadelhalter, links gebogen, TC-Einsatz, Arbeitslänge 330mm, <b>zerlegbar</b>                  Ø 5mm angled axial needleholder, curved left, TC-insert, working length 330mm, <b>detachable</b></p>	
<b>EG-003-072</b>	<p>Ø 5mm gewinkelter axialer Nadelhalter, rechts gebogen, TC-Einsatz, Arbeitslänge 330mm, <b>zerlegbar</b>                  Ø 5mm angled axial needleholder, curved right, TC-insert, working length 330mm, <b>detachable</b></p>	



**Bestell-Nr.**  
**Ordering no.**

<b>EG-003-066</b>	<p>Ø 5mm gewinkelter axialer Nadelhalter, gerade, TC-Einsatz, Arbeitslänge 330mm, <b>zerlegbar</b> (modular)                  Ø 5mm angled axial needleholder, straight, TC-insert, working length 330mm, <b>detachable</b> (modular)</p>	
<b>EG-003-067</b>	<p>Ø 5mm gewinkelter axialer Nadelhalter, links gebogen, TC-Einsatz, Arbeitslänge 330mm, <b>zerlegbar</b> (modular)                  Ø 5mm angled axial needleholder, curved left, TC-insert, working length 330mm, <b>detachable</b> (modular)</p>	
<b>EG-003-068</b>	<p>Ø 5mm gewinkelter axialer Nadelhalter, rechts gebogen, TC-Einsatz, Arbeitslänge 330mm, <b>zerlegbar</b> (modular)                  Ø 5mm angled axial needleholder, curved right, TC-insert, working length 330mm, <b>detachable</b> (modular)</p>	
<b>EG-003-069</b>	<p>Ø 5mm gewinkelter axialer Nadelhalter, gerade, selbstjustierend, diamantbeschichtet, Arbeitslänge 330mm, <b>zerlegbar</b> (modular)                  Ø 5mm angled axial needleholder, straight, selfadjusting, diamond coated, working length 330mm, <b>detachable</b> (modular)</p>	

**Hinweis:** Alle Einzelkomponenten können auch separat geordert werden. Bitte kontaktieren Sie uns.

**Advice:** All single components can also be ordered separately. Please kindly contact us.







**Bestell-Nr.**  
**Ordering no.**

<b>EG-003-101</b>	<p>Ø 5mm Nadelhalter, gerade, Ringgriff, TC-Einsatz, Arbeitslänge 330mm, <b>zerlegbar</b> (modular)          Ø 5mm needleholder, straight, ring handle, TC-insert, working length 330mm, <b>detachable</b> (modular)</p>	
<b>EG-003-102</b>	<p>Ø 5mm Nadelhalter, links gebogen, Ringgriff, TC-Einsatz, Arbeitslänge 330mm, <b>zerlegbar</b> (modular)          Ø 5mm needleholder, curved left, ring handle, TC-insert, working length 330mm, <b>detachable</b> (modular)</p>	
<b>EG-003-103</b>	<p>Ø 5mm Nadelhalter, rechts gebogen, Ringgriff, TC-Einsatz, Arbeitslänge 330mm, <b>zerlegbar</b> (modular)          Ø 5mm needleholder, curved right, ring handle, TC-insert, working length 330mm, <b>detachable</b> (modular)</p>	
<b>EG-003-104</b>	<p>Ø 5mm Nadelhalter, gerade, selbstjustierend, Ringgriff, diamantbeschichtet, Arbeitslänge 330mm, <b>zerlegbar</b> (modular)          Ø 5mm needleholder, straight, self adjusting, ring handle, diamond coated, working length 330mm, <b>detachable</b> (modular)</p>	
<b>EG-003-041</b>	<p>Ø 5mm Assistent-Nadelhalter, aufgebogen, Ringgriff, TC-Einsatz, Arbeitslänge 330mm, <b>zerlegbar</b> (modular)          Ø 5mm assistant needleholder, curved upwards, ring handle, TC-insert, working length 330mm, <b>detachable</b> (modular)</p>	

**Hinweis:** Alle Einzelkomponenten können auch separat geordert werden. Bitte kontaktieren Sie uns.

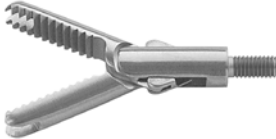
**Advice:** All single components can also be ordered separately. Please kindly contact us.

5mm Einsatz allein Insert only			5mm Instrument komplett Instrument complete		
					
330mm	450mm	Maul Tip	Bezeichnung Description	330mm	450mm
EC-005-291	EC-005-292		<b>Darzy</b> Knotenschieber, doppelbeweglich <b>Darzy</b> knot pusher, double action	EC-005-293	EC-005-294

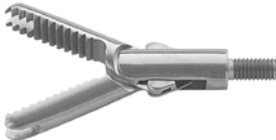
5mm Einsatz allein Insert only			5mm Instrument komplett Instrument complete		
					
330mm	450mm	Maul Tip	Bezeichnung Description	330mm	450mm
EC-005-291	EC-005-292		<b>Darzy</b> Knotenschieber, doppelbeweglich <b>Darzy</b> knot pusher, double action	EC-505-293	EC-505-294

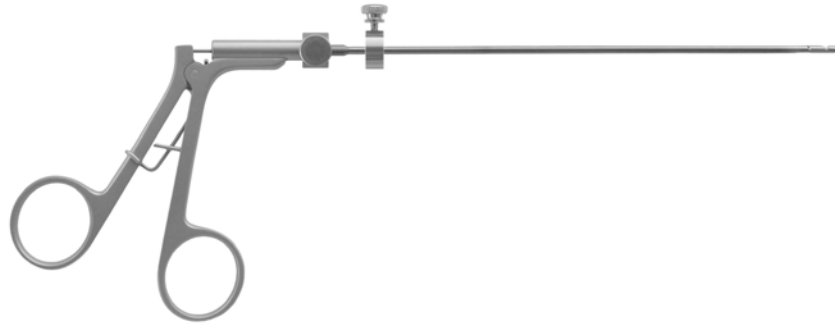

**Bestell-Nr.**  
**Ordering no.**

**EG-004-001**    Ø 5mm Nahtschließinstrument  
                  Ø 5mm fascia closure instrument



**Bestell-Nr.**  
**Ordering no.**

**EG-004-002**    Ø 2.3mm Fascia Nähhilfe, Arbeitslänge 140mm  
                  Ø 2.3mm fascia assisted instrument, working length 140mm



**Bestell-Nr.**  
**Ordering no.**

**EG-001-001**    Ø 4mm Knotenführer mit Öse, Arbeitslänge 330mm  
                  Ø 4mm knot pusher with loop, working length 330mm

**EG-001-011**    Ø 4mm Knotenführer mit Öse, Arbeitslänge 450mm  
                  Ø 4mm knot pusher with loop, working length 450mm

**EG-001-003**    Ø 4mm Knotenführer mit geschlossener Öse, Arbeitslänge 330mm  
                  Ø 4mm knot pusher with closed loop, working length 330mm

**EG-001-013**    Ø 4mm Knotenführer mit geschlossener Öse, Arbeitslänge 450mm  
                  Ø 4mm knot pusher with closed loop, working length 450mm

**EG-001-002**    Ø 4.5mm Knotenführer mit Schlitz, Arbeitslänge 330mm  
                  Ø 4.5mm knot pusher with slot, working length 330mm







**Bestell-Nr.  
Ordering no.**

<b>EG-002-030</b>	Ø 10mm Clipanlegezange, drehbar, Luer-Lock Spülansatz, Ethicon <b>medium</b> Ø 10mm clip applying forceps, rotatable, Luer-Lock rinsing channel, Ethicon <b>medium</b>	
<b>EG-002-031</b>	Ø 10mm Clipanlegezange, drehbar, Luer-Lock Spülansatz, Ethicon <b>medium/large</b> Ø 10mm clip applying forceps, rotatable, Luer-Lock rinsing channel, Ethicon <b>medium/large</b>	<b>ETHICON</b>
<b>EG-002-032</b>	Ø 10mm Clipanlegezange, drehbar, Luer-Lock Spülansatz, Ethicon <b>large</b> Ø 10mm clip applying forceps, rotatable, Luer-Lock rinsing channel, Ethicon <b>large</b>	
<b>EG-002-035</b>	Ø 10mm Clipanlegezange, drehbar, Luer-Lock Spülansatz, Pilling <b>medium</b> Ø 10mm clip applying forceps, rotatable, Luer-Lock rinsing channel, Pilling <b>medium</b>	<b>PILLING</b>
<b>EG-002-036</b>	Ø 10mm Clipanlegezange, drehbar, Luer-Lock Spülansatz, Pilling <b>medium/large</b> Ø 10mm clip applying forceps, rotatable, Luer-Lock rinsing channel, Pilling <b>medium/large</b>	
<b>EG-002-040</b>	Ø 10mm Clipanlegezange, drehbar, Luer-Lock Spülansatz, SLS <b>small</b> Ø 10mm clip applying forceps, rotatable, Luer-Lock rinsing channel, SLS <b>small</b>	
<b>EG-002-041</b>	Ø 10mm Clipanlegezange, drehbar, Luer-Lock Spülansatz, SLS <b>medium</b> Ø 10mm clip applying forceps, rotatable, Luer-Lock rinsing channel, SLS <b>medium</b>	<b>SLS</b>
<b>EG-002-042</b>	Ø 10mm Clipanlegezange, drehbar, Luer-Lock Spülansatz, SLS <b>medium/large</b> Ø 10mm clip applying forceps, rotatable, Luer-Lock rinsing channel, SLS <b>medium/large</b>	
<b>EG-002-043</b>	Ø 10mm Clipanlegezange, drehbar, Luer-Lock Spülansatz, SLS <b>large</b> Ø 10mm clip applying forceps, rotatable, Luer-Lock rinsing channel, SLS <b>large</b>	
<b>EG-002-046</b>	Ø 10mm Clipanlegezange, drehbar, Luer-Lock Spülansatz, Horizon <b>medium/large</b> Ø 10mm clip applying forceps, rotatable, Luer-Lock rinsing channel, Horizon <b>medium/large</b>	<b>HORIZON</b>

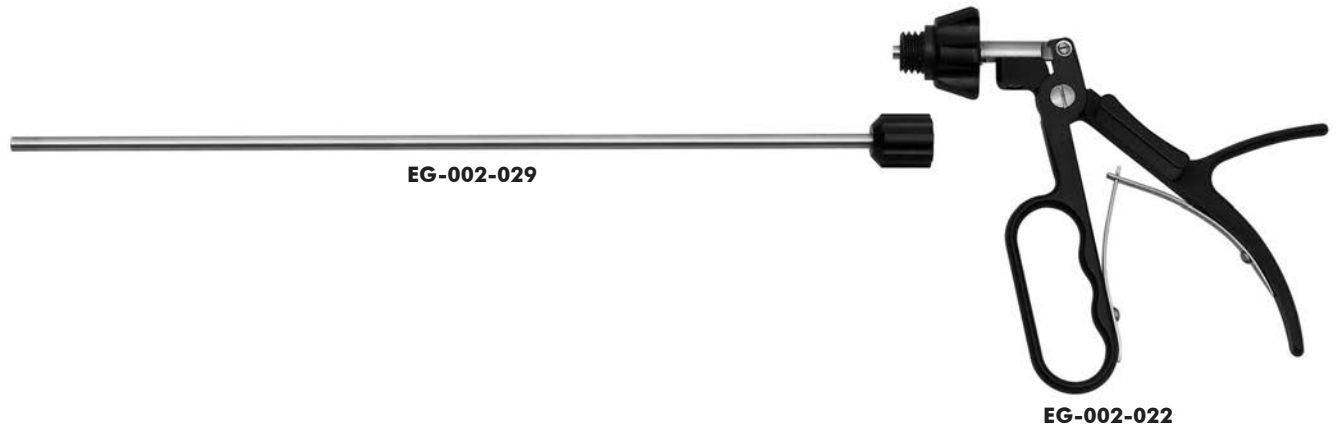

Bestell-Nr. Ordering no.	
<b>EG-002-022</b>	Handgriff für alle zerlegbaren Ø 5mm Clipanlegezangen <i>Handpiece for all detachable Ø 5mm clip applying forceps</i>
<b>EG-002-029</b>	Schaft für alle zerlegbaren Ø 5mm Clipanlegezangen <i>Sheath for all detachable Ø 5mm clip applying forceps</i>



Bestell-Nr. Ordering no.		
<b>EG-002-020</b>	Ø 5mm Clipanlegezange, zerlegbar, <b>komplett</b> , Ethicon <b>small</b> Ø 5mm clip applying forceps, detachable, <b>complete</b> , Ethicon <b>small</b>	
<b>EG-002-021</b>	Einsatz Ø 5mm Clipanlegezange, Ethicon <b>small</b> Insert Ø 5mm clip applying forceps, Ethicon <b>small</b>	
<b>EG-002-025</b>	Ø 5mm Clipanlegezange, zerlegbar, <b>komplett</b> , Ethicon <b>medium</b> Ø 5mm clip applying forceps, detachable, <b>complete</b> , Ethicon <b>medium</b>	<b>ETHICON</b>
<b>EG-002-027</b>	Einsatz Ø 5mm Clipanlegezange, Ethicon <b>medium</b> Insert Ø 5mm clip applying forceps, Ethicon <b>medium</b>	
<b>EG-002-023</b>	Ø 5mm Clipanlegezange, zerlegbar, <b>komplett</b> , Pilling <b>small</b> Ø 5mm clip applying forceps, detachable, <b>complete</b> , Pilling <b>small</b>	<b>PILLING</b>
<b>EG-002-024</b>	Einsatz Ø 5mm Clipanlegezange, Pilling <b>small</b> Insert Ø 5mm clip applying forceps, Pilling <b>small</b>	
<b>EG-002-026</b>	Ø 5mm Clipanlegezange, zerlegbar, <b>komplett</b> , Pilling <b>medium</b> Ø 5mm clip applying forceps, detachable, <b>complete</b> , Pilling <b>medium</b>	
<b>EG-002-028</b>	Einsatz Ø 5mm Clipanlegezange, Pilling <b>medium</b> Insert Ø 5mm clip applying forceps, Pilling <b>medium</b>	

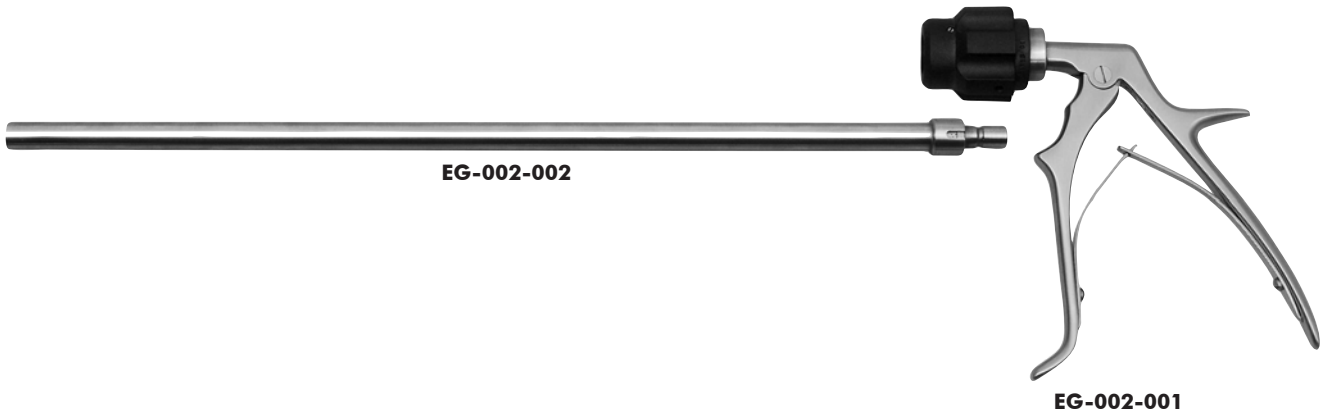

**Bestell-Nr.  
Ordering no.**

<b>EG-002-001</b>	Handgriff für alle zerlegbaren Ø 10mm Clipanlegezangen Handpiece for all detachable Ø 10mm clip applying forceps
<b>EG-002-002</b>	Schaft für alle zerlegbaren Ø 10mm Clipanlegezangen Sheath for all detachable Ø 10mm clip applying forceps



**Bestell-Nr.  
Ordering no.**

<b>EG-002-010</b>	Ø 10mm Clipanlegezange, zerlegbar, <b>komplett</b> , Ethicon <b>medium</b> Ø 10mm clip applying forceps, detachable, <b>complete</b> , Ethicon <b>medium</b>	<b>ETHICON</b>
<b>EG-002-003</b>	Einsatz Ø 10mm Clipanlegezange, Ethicon <b>medium</b> Insert Ø 10mm clip applying forceps, Ethicon <b>medium</b>	
<b>EG-002-011</b>	Ø 10mm Clipanlegezange, zerlegbar, <b>komplett</b> , Ethicon <b>medium/large</b> Ø 10mm clip applying forceps, detachable, <b>complete</b> , Ethicon <b>medium/large</b>	
<b>EG-002-004</b>	Einsatz Ø 10mm Clipanlegezange, Ethicon <b>medium/large</b> Insert Ø 10mm clip applying forceps, Ethicon <b>medium/large</b>	
<b>EG-002-012</b>	Ø 10mm Clipanlegezange, zerlegbar, <b>komplett</b> , Ethicon <b>large</b> Ø 10mm clip applying forceps, detachable, <b>complete</b> , Ethicon <b>large</b>	<b>PILLING</b>
<b>EG-002-005</b>	Einsatz Ø 10mm Clipanlegezange, Ethicon <b>large</b> Insert Ø 10mm clip applying forceps, Ethicon <b>large</b>	
<b>EG-002-013</b>	Ø 10mm Clipanlegezange, zerlegbar, <b>komplett</b> , Pilling <b>medium</b> Ø 10mm clip applying forceps, detachable, <b>complete</b> , Pilling <b>medium</b>	
<b>EG-002-006</b>	Einsatz Ø 10mm Clipanlegezange, Pilling <b>medium</b> Insert Ø 10mm clip applying forceps, Pilling <b>medium</b>	
<b>EG-002-014</b>	Ø 10mm Clipanlegezange, zerlegbar, <b>komplett</b> , Pilling <b>medium/large</b> Ø 10mm clip applying forceps, detachable, <b>complete</b> , Pilling <b>medium/large</b>	
<b>EG-002-007</b>	Einsatz Ø 10mm Clipanlegezange, Pilling <b>medium/large</b> Insert Ø 10mm clip applying forceps, Pilling <b>medium/large</b>	
<b>EG-002-015</b>	Ø 10mm Clipanlegezange, zerlegbar, <b>komplett</b> , Pilling <b>large</b> Ø 10mm clip applying forceps, detachable, <b>complete</b> , Pilling <b>large</b>	
<b>EG-002-008</b>	Einsatz Ø 10mm Clipanlegezange, Pilling <b>large</b> Insert Ø 10mm clip applying forceps, Pilling <b>large</b>	

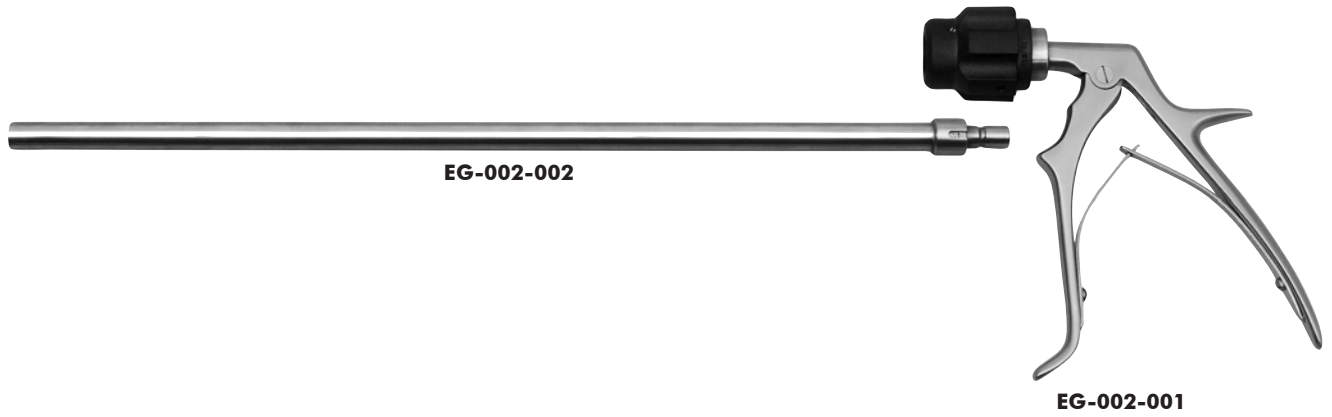

Bestell-Nr. Ordering no.	
<b>EG-002-001</b>	Handgriff für alle zerlegbaren Ø 10mm Clipanlegezangen <i>Handpiece for all detachable Ø 10mm clip applying forceps</i>
<b>EG-002-002</b>	Schaft für alle zerlegbaren Ø 10mm Clipanlegezangen <i>Sheath for all detachable Ø 10mm clip applying forceps</i>



Bestell-Nr. Ordering no.		
<b>EG-002-050</b>	Ø 10mm Clipanlegezange, zerlegbar, <b>komplett</b> , SLS <b>small</b> Ø 10mm clip applying forceps, detachable, <b>complete</b> , SLS <b>small</b>	
<b>EG-002-055</b>	Einsatz Ø 10mm Clipanlegezange, SLS <b>small</b> Insert Ø 10mm clip applying forceps, SLS <b>small</b>	
<b>EG-002-051</b>	Ø 10mm Clipanlegezange, zerlegbar, <b>komplett</b> , SLS <b>medium</b> Ø 10mm clip applying forceps, detachable, <b>complete</b> , SLS <b>medium</b>	
<b>EG-002-056</b>	Einsatz Ø 10mm Clipanlegezange, SLS <b>medium</b> Insert Ø 10mm clip applying forceps, SLS <b>medium</b>	
<b>EG-002-052</b>	Ø 10mm Clipanlegezange, zerlegbar, <b>komplett</b> , SLS <b>medium/large</b> Ø 10mm clip applying forceps, detachable, <b>complete</b> , SLS <b>medium/large</b>	<b>SLS</b>
<b>EG-002-057</b>	Einsatz Ø 10mm Clipanlegezange, SLS <b>medium/large</b> Insert Ø 10mm clip applying forceps, SLS <b>medium/large</b>	
<b>EG-002-053</b>	Ø 10mm Clipanlegezange, zerlegbar, <b>komplett</b> , SLS <b>large</b> Ø 10mm clip applying forceps, detachable, <b>complete</b> , SLS <b>large</b>	
<b>EG-002-058</b>	Einsatz Ø 10mm Clipanlegezange, SLS <b>large</b> Insert Ø 10mm clip applying forceps, SLS <b>large</b>	

**Bestell-Nr.**  
**Ordering no.**

<b>EL-010-010</b>	Hemostatic clips, Ethicon <b>LT 100</b> , 1 Box beinhaltet 216 Clips <i>Hemostatic clips, Ethicon <b>LT 100</b>, 1 box includes 216 clips</i>	
<b>EL-010-011</b>	Hemostatic clips, Ethicon <b>LT 200</b> , 1 Box beinhaltet 216 Clips <i>Hemostatic clips, Ethicon <b>LT 200</b>, 1 box includes 216 clips</i>	<b>ETHICON</b>
<b>EL-010-012</b>	Hemostatic clips, Ethicon <b>LT 300</b> , 1 Box beinhaltet 108 Clips <i>Hemostatic clips, Ethicon <b>LT 300</b>, 1 box includes 108 clips</i>	
<b>EL-010-013</b>	Hemostatic clips, Ethicon <b>LT 400</b> , 1 Box beinhaltet 108 Clips <i>Hemostatic clips, Ethicon <b>LT 400</b>, 1 box includes 108 clips</i>	



**Bestell-Nr.**  
**Ordering no.**

**EI-001-001**    Ø 5mm Endoretraktor, 3 Finger, Spülanschluß, Arbeitslänge 330mm  
 Ø 5mm endo retractor, 3 fingers, irrigation port, working length 330mm

**EI-001-011**    Ø 5mm Endoretraktor, 3 Finger gebogen, Spülanschluß, Arbeitslänge 330mm  
 Ø 5mm endo retractor, 3 fingers bended, irrigation port, working length 330mm



**Bestell-Nr.**  
**Ordering no.**

**EI-001-002**    Ø 10mm Endoretraktor, 5 Finger, Spülanschluß, Arbeitslänge 380mm  
 Ø 10mm endo retractor, 5 fingers, irrigation port, working length 380mm

**EI-001-012**    Ø 10mm Endoretraktor, 5 Finger gebogen, Spülanschluß, Arbeitslänge 380mm  
 Ø 10mm endo retractor, 5 fingers bended, irrigation port, working length 380mm



**Bestell-Nr.**  
**Ordering no.**

**EI-001-003**    Ø 5mm abwinkelbarer Endoretraktor, 3 Finger, Spülanschluß, Arbeitslänge 330mm  
 Ø 5mm articulating endo retractor, 3 fingers, irrigation port, working length 330mm

**EI-001-013**    Ø 5mm abwinkelbarer Endoretraktor, 3 Finger gebogen, Spülanschluß, Arbeitslänge 330mm  
 Ø 5mm articulating endo retractor, 3 fingers bended, irrigation port, working length 330mm



**Bestell-Nr.**  
**Ordering no.**

**EI-001-004**    Ø 10mm abwinkelbarer Endoretraktor, 5 Finger, Spülanschluß, Arbeitslänge 380mm  
 Ø 10mm articulating endo retractor, 5 fingers, irrigation port, working length 380mm

**EI-001-014**    Ø 10mm abwinkelbarer Endoretraktor, 5 Finger gebogen, Spülanschluß, Arbeitslänge 380mm  
 Ø 10mm articulating endo retractor, 5 fingers bended, irrigation port, working length 380mm



**Bestell-Nr.  
Ordering no.**

**EI-001-034** Ø 10mm abwinkelbarer Endoretraktor, 5 Finger gebogen, **zerlegbar**, Arbeitslänge 380mm  
Ø 10mm articulating endo retractor, 5 fingers bended, **detachable**, working length 380mm

**EI-001-035** Ø 10mm abwinkelbarer Endoretraktor, 5 Finger gebogen, **zerlegbar**, Arbeitslänge 450mm  
Ø 10mm articulating endo retractor, 5 fingers bended, **detachable**, working length 450mm



**Bestell-Nr.  
Ordering no.**

**EI-002-001** Ø 5mm Ösophagus Retraktor, 1 Finger, Spülanschluß, Arbeitslänge 330mm  
Ø 5mm esophagus retractor, 1 finger, irrigation port, working length 330mm

**EI-002-011** Ø 5mm Ösophagus Retraktor, 1 Finger, Spülanschluß, Arbeitslänge 440mm  
Ø 5mm esophagus retractor, 1 finger, irrigation port, working length 440mm



**Bestell-Nr.  
Ordering no.**

**EI-002-002** Ø 10mm Ösophagus Retraktor, 1 Finger, Spülanschluß, Arbeitslänge 330mm  
Ø 10mm esophagus retractor, 1 finger, irrigation port, working length 330mm

**EI-002-012** Ø 10mm Ösophagus Retraktor, 1 Finger, Spülanschluß, Arbeitslänge 440mm  
Ø 10mm esophagus retractor, 1 finger, irrigation port, working length 440mm



**Bestell-Nr.**  
**Ordering no.**

<b>EI-001-050</b>	<p>Ø 5mm justierbarer Endoretraktor, Länge geöffnet 530mm, Länge geschlossen (Arbeitsposition) 360mm, Breite geschlossen (Arbeitsposition) 80mm, Spülanschluß          Ø 5mm adjustable endo retractor, length opened 530mm, length closed (working position) 360mm, width closed (working position) 80mm, irrigation port</p>
<b>EI-001-052</b>	<p>Ø 5mm justierbarer Endoretraktor, Länge geöffnet 530mm, Länge geschlossen (Arbeitsposition) 450mm, Breite geschlossen (Arbeitsposition) 80mm, Spülanschluß          Ø 5mm adjustable endo retractor, length opened 530mm, length closed (working position) 450mm, width closed (working position) 80mm, irrigation port</p>
<b>EI-001-053</b>	<p>Ø 5mm justierbarer Endoretraktor, Länge geöffnet 530mm, Länge geschlossen (Arbeitsposition) 360mm, Breite geschlossen (Arbeitsposition) 60mm, Spülanschluß          Ø 5mm adjustable endo retractor, length opened 530mm, length closed (working position) 360mm, width closed (working position) 60mm, irrigation port</p>
<b>EI-001-054</b>	<p>Ø 5mm justierbarer Endoretraktor, Länge geöffnet 530mm, Länge geschlossen (Arbeitsposition) 450mm, Breite geschlossen (Arbeitsposition) 60mm, Spülanschluß          Ø 5mm adjustable endo retractor, length opened 530mm, length closed (working position) 450mm, width closed (working position) 60mm, irrigation port</p>
<b>EI-001-055</b>	<p>Ø 5mm justierbarer Endoretraktor, Länge geöffnet 530mm, Länge geschlossen (Arbeitsposition) 360mm, Breite geschlossen (Arbeitsposition) 80mm, <b>30° aufgewinkelt</b>, Spülanschluß          Ø 5mm adjustable endo retractor, length opened 530mm, length closed (working position) 360mm, width closed (working position) 80mm, <b>30° angled upwards</b>, irrigation port</p>
<b>EI-001-056</b>	<p>Ø 5mm justierbarer Endoretraktor, Länge geöffnet 530mm, Länge geschlossen (Arbeitsposition) 450mm, Breite geschlossen (Arbeitsposition) 80mm, <b>30° aufgewinkelt</b>, Spülanschluß          Ø 5mm adjustable endo retractor, length opened 530mm, length closed (working position) 450mm, width closed (working position) 80mm, <b>30° angled upwards</b>, irrigation port</p>
<b>EI-001-057</b>	<p>Ø 5mm justierbarer Endoretraktor, Länge geöffnet 530mm, Länge geschlossen (Arbeitsposition) 360mm, Breite geschlossen (Arbeitsposition) 60mm, <b>30° aufgewinkelt</b>, Spülanschluß          Ø 5mm adjustable endo retractor, length opened 530mm, length closed (working position) 360mm, width closed (working position) 60mm, <b>30° angled upwards</b>, irrigation port</p>
<b>EI-001-058</b>	<p>Ø 5mm justierbarer Endoretraktor, Länge geöffnet 530mm, Länge geschlossen (Arbeitsposition) 450mm, Breite geschlossen (Arbeitsposition) 60mm, <b>30° aufgewinkelt</b>, Spülanschluß          Ø 5mm adjustable endo retractor, length opened 530mm, length closed (working position) 450mm, width closed (working position) 60mm, <b>30° angled upwards</b>, irrigation port</p>



**Bestell-Nr.**  
**Ordering no.**

<b>ED-020-001</b>	<p>Ø 5mm Cholangiographiezange, doppelbeweglich, Griff mit Sperre, Spülanschluß, Arbeitslänge 330mm          Ø 5mm cholangiography forceps, double action, handle with ratchet, irrigation port, working length 330mm</p>
-------------------	---





**Bestell-Nr.  
Ordering no.**

**EK-020-001** Ø 5mm bipolare 90° Hakenelektrode, Arbeitslänge 340mm  
Ø 5mm bipolar 90° hook electrode, working length 340mm



**EK-020-003** Ø 5mm bipolare J-Hakenelektrode, Arbeitslänge 340mm  
Ø 5mm bipolar J-hook electrode, working length 340mm



**EK-020-005** Ø 5mm bipolare Spatelektrode, Arbeitslänge 340mm  
Ø 5mm bipolar spatula electrode, working length 340mm



**EK-020-006** Ø 5mm bipolare Knopfelektrode, Arbeitslänge 340mm  
Ø 5mm bipolar button electrode, working length 340mm



**EK-020-002** Ø 5mm bipolare Tellerelektrode, Arbeitslänge 340mm  
Ø 5mm bipolar plate electrode, working length 340mm



**Bestell-Nr.  
Ordering no.**

**EK-000-001** Ø 5mm bipolare Koagulationszange, Pinzettenspitze, Federgriff, Flachstecker, Arbeitslänge 340mm  
Ø 5mm bipolar coagulation forceps, fluted bit, spring handle, flat plug, working length 340mm



**EK-000-002** Ø 5mm bipolare Koagulationszange, Pinzettenspitze, Federgriff, Flachstecker, Arbeitslänge 450mm  
Ø 5mm bipolar coagulation forceps, fluted bit, spring handle, flat plug, working length 450mm



**EK-000-003** Ø 5mm bipolare Tubenkoagulationszange, gewellter Steg, Federgriff, Flachstecker, AL 340mm  
Ø 5mm bipolar tube coagulation forceps, rippled bar, spring handle, flat plug, WL 340mm



**EK-000-004** Ø 5mm bipolare Tubenkoagulationszange, gewellter Steg, Federgriff, Flachstecker, AL 450mm  
Ø 5mm bipolar tube coagulation forceps, rippled bar, spring handle, flat plug, WL 450mm



**EK-000-005** Ø 5mm bipolare Tubenkoagulationszange, zangenartiges Maul, Federgriff, Flachstecker, AL 340mm  
Ø 5mm bipolar tube coagulation forceps, tongue type tip, spring handle, flat plug, WL 340mm



**EK-000-006** Ø 5mm bipolare Tubenkoagulationszange, zangenartiges Maul, Federgriff, Flachstecker, AL 450mm  
Ø 5mm bipolar tube coagulation forceps, tongue type tip, spring handle, flat plug, WL 450mm





**Bestell-Nr.**  
**Ordering no.**

**EK-001-007**

Ringgriff für zerlegbare bipolare  
Koagulationszangen  
*Ring handle for detachable bipolar  
coagulation forceps*



**Bestell-Nr.**  
**Ordering no.**

**EK-002-008**

Standardgriff für zerlegbare bipolare  
Koagulationszangen  
*Standard handle for detachable bipolar  
coagulation forceps*



**Bestell-Nr.**  
**Ordering no.**

**EK-001-003**

Innenrohr für zerlegbare Koagulationszange, 340mm  
*Inner sheath for detachable coagulation forceps, 340mm*

**EK-001-005**

Innenrohr für zerlegbare Koagulationszange, 450mm  
*Inner sheath for detachable coagulation forceps, 450mm*











**Bestell-Nr.**  
**Ordering no.**

**EK-001-004**

Ø 5mm Außenrohr für zerlegbare Koagulationszangen, 340mm  
*Ø 5mm outer sheath for detachable coagulation forceps, 340mm*

**EK-001-006**

Ø 5mm Außenrohr für zerlegbare Koagulationszangen, 450mm  
*Ø 5mm outer sheath for detachable coagulation forceps, 450mm*

Einsatz allein Insert only			Instrument komplett Instrument complete		
					
330mm	450mm	Maul Tip	Bezeichnung Description	330mm	450mm
EK-005-010	EK-005-020		<b>Tubenfasszangenelektrode,</b> gewellter Steg <b>Tubal grasping forceps</b> <b>electrode,</b> rippled bar	EK-001-010	EK-001-020
EK-005-011	EK-005-021		<b>Pinzettenelektrode,</b> 1mm Spitze <b>Fluted bit electrode,</b> 1mm tip	EK-001-011	EK-001-021
EK-005-012	EK-005-022		<b>Kleppingerelektrode,</b> gerieft <b>Kleppinger electrode,</b> serrated	EK-001-012	EK-001-022
EK-005-013	EK-005-023		<b>Plattenelektrode,</b> 3mm <b>Plate electrode,</b> 3mm	EK-001-013	EK-001-023
EK-005-014	EK-005-024		<b>Maryland</b> Dissektionselektrode, gebogen <b>Maryland</b> dissecting electrode, curved	EK-001-014	EK-001-024
EK-005-015	EK-005-025		<b>Scherenelektrode,</b> gebogen <b>Scissors electrode,</b> curved	EK-001-015	EK-001-025
EK-005-016	EK-005-026		<b>Scherenelektrode, TC,</b> gebogen <b>Scissors electrode, TC,</b> curved	EK-001-016	EK-001-026

**Bestell-Nr.**  
**Ordering no.**

**EK-010-008**

Adapter für 2-Pin Stecker  
Adapter for 2-pin plug



**EK-010-009**

Adapter für Flachstecker-Bipolarkabel  
Adapter for flat plug bipolar cable



Einsatz allein <i>Insert only</i>			Instrument komplett <i>Instrument complete</i>		
330mm	450mm	Maul Tip	Bezeichnung Description	330mm	450mm
EK-005-010	EK-005-020		<b>Tubenfasszangenelektrode,</b> gewellter Steg <b>Tubal grasping forceps</b> <b>electrode, rippled bar</b>	EK-002-010	EK-002-020
EK-005-011	EK-005-021		<b>Pinzettenelektrode,</b> 1mm Spitze <b>Fluted bit electrode,</b> 1mm tip	EK-002-011	EK-002-021
EK-005-012	EK-005-022		<b>Kleppingerelektrode,</b> gerieft <b>Kleppinger electrode,</b> serrated	EK-002-012	EK-002-022
EK-005-013	EK-005-023		<b>Plattenelektrode,</b> 3mm <b>Plate electrode,</b> 3mm	EK-002-013	EK-002-023
EK-005-014	EK-005-024		<b>Maryland</b> Dissektionslektrode, gebogen <b>Maryland</b> dissecting electrode, curved	EK-002-014	EK-002-024
EK-005-015	EK-005-025		<b>Scherenelektrode,</b> gebogen <b>Scissors electrode,</b> curved	EK-002-015	EK-002-025
EK-005-016	EK-005-026		<b>Scherenelektrode, TC,</b> gebogen <b>Scissors electrode, TC,</b> curved	EK-002-016	EK-002-026

**Bestell-Nr.**  
**Ordering no.**

**EK-010-008** Adapter für 2-Pin Stecker  
*Adapter for 2-pin plug*



**EK-010-009** Adapter für Flachstecker-Bipolarkabel  
*Adapter for flat plug bipolar cable*





**Bestell-Nr.**  
**Ordering no.**

**EK-003-003**









Griff für zerlegbare bipolare Superline  
Koagulationszangen  
Handle for detachable bipolar Superline  
coagulation forceps



**Bestell-Nr.**  
**Ordering no.**

**EK-003-002**

Ø 5mm Schaft für zerlegbare bipolare Superline Koagulationszangen, 340mm  
Ø 5mm sheath for detachable bipolar Superline coagulation forceps, 340mm

Einsatz allein Insert only		Instrument komplett Instrument complete	
			
330mm	Maul Tip	Bezeichnung Description	330mm
EK-003-010		Fasszangenelektrode, 3mm Grasping forceps electrode, 3mm	EK-003-020
EK-003-011		Metzenbaum Scherenelektrode Metzenbaum scissors electrode	EK-003-021
EK-003-012		Maryland Elektrode Maryland electrode	EK-003-022
EK-003-013		Fasszangenelektrode, gebogen Grasping forceps electrode, curved	EK-003-023
EK-003-014		Pinzettenelektrode Forceps electrode	EK-003-024
EK-003-015		Fasszangenelektrode Grasping forceps electrode	EK-003-025
EK-003-016		Hakenzangenelektrode Claw forceps electrode	EK-003-026



**Bestell-Nr.**  
**Ordering no.**

**EK-003-039** Drehbarer Griff mit Arretierung für zerlegbare bipolare Koagulationszangen  
*Rotatable handle with locking device for detachable bipolar coagulation forceps*

**EK-003-040** Drehbarer Griff für zerlegbare bipolare Koagulationszangen  
*Rotatable handle for detachable bipolar coagulation forceps*



**Bestell-Nr.**  
**Ordering no.**

**EK-003-041** Ø 5mm Schaft für zerlegbare bipolare Superline Koagulationszangen, 340mm  
*Ø 5mm sheath for detachable bipolar Superline coagulation forceps, 340mm*

Einsatz allein <i>Insert only</i>		Instrument komplett <i>Instrument complete</i>	
<b>340mm</b>	<b>Maul Tip</b>	<b>Bezeichnung Description</b>	<b>340mm</b>
<b>EK-003-042</b>		<b>Metzenbaum</b> Scherenelektrode <i>Metzenbaum scissors electrode</i>	<b>EK-003-052</b>
<b>EK-003-043</b>		<b>Fasszangenelektrode,</b> gefenestert <b>Grasping forceps electrode,</b> <i>fenestrated</i>	<b>EK-003-053</b>
<b>EK-003-044</b>		<b>Fasszangenelektrode,</b> gebogen, gefenestert <b>Grasping forceps electrode,</b> <i>curved, fenestrated</i>	<b>EK-003-054</b>
<b>EK-003-045</b>		<b>Maryland</b> Elektrode <i>Maryland electrode</i>	<b>EK-003-055</b>

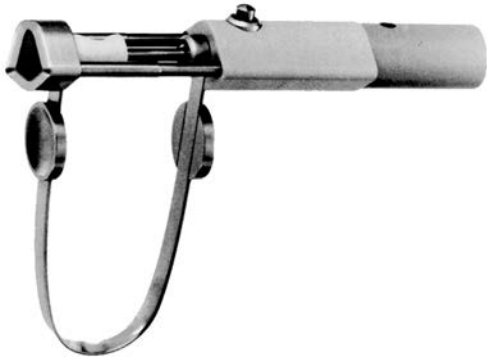

**Bestell-Nr.**  
**Ordering no.**

**EK-004-001**

Federgriff für zerlegbare bipolare  
Koagulationszangen  
*Spring handle for bipolar coagulation  
forceps*



**Bestell-Nr.**  
**Ordering no.**

**EK-004-051**

Ringgriff für zerlegbare bipolare  
Koagulationszangen  
*Ring handle for detachable bipolar  
coagulation forceps*



**Bestell-Nr.**  
**Ordering no.**

**EK-004-002**

Ø 5mm Kunststoffrohr für zerlegbare bipolare Koagulationszangen, 330mm  
*Ø 5mm plastic sheath for modular bipolar coagulation forceps, 330mm*

**EK-004-004**

Ø 5mm Kunststoffrohr für zerlegbare bipolare Koagulationszangen, 430mm  
*Ø 5mm plastic sheath for detachable bipolar coagulation forceps, 430mm*







**Bestell-Nr.**  
**Ordering no.**





**EK-004-003**

Ø 5mm Metallrohr für zerlegbare bipolare Koagulationszangen, 330mm  
*Ø 5mm metal sheath for modular bipolar coagulation forceps, 330mm*





**EK-004-005**

Ø 5mm Metallrohr für zerlegbare bipolare Koagulationszangen, 430mm  
*Ø 5mm metal sheath for detachable bipolar coagulation forceps, 430mm*

Einsatz allein <i>Insert only</i>			Instrument komplett <i>Instrument complete</i>		
					
330mm	450mm	Maul Tip	Bezeichnung Description	330mm	450mm
EK-004-023	EK-004-030		Plattenelektrode, 3mm <i>Plate electrode,</i> 3mm	EK-004-013	EK-004-019
EK-004-021	EK-004-028		Pinzettenelektrode, 1mm Spitze <i>Fluted bit electrode,</i> 1mm tip	EK-004-011	EK-004-018
EK-004-020	EK-004-027		Tubenfasszangenelektrode, gewellter Steg <i>Tubal grasping forceps</i> <i>electrode, rippled bar</i>	EK-004-010	EK-004-017





Einsatz allein <i>Insert only</i>			Instrument komplett <i>Instrument complete</i>		
					
330mm	450mm	Maul Tip	Bezeichnung Description	330mm	450mm
EK-004-023	EK-004-030		Plattenelektrode, 3mm <i>Plate electrode,</i> 3mm	EK-004-063	EK-004-069
EK-004-021	EK-004-028		Pinzettenelektrode, 1mm Spitze <i>Fluted bit electrode,</i> 1mm tip	EK-004-061	EK-004-068
EK-004-020	EK-004-027		Tubenfasszangenelektrode, gewellter Steg <i>Tubal grasping forceps</i> <i>electrode, rippled bar</i>	EK-004-060	EK-004-067







Anschluss Ø 4mm Instrumentenseite Connection Ø 4mm instrument side	Anschluss Geräteseite Connection unit side
	 <p><b>EE-010-001 / EE-010-011</b></p>
	 <p><b>EE-010-002 / EE-010-012</b></p>
	 <p><b>EE-010-003 / EE-010-013</b></p>
	 <p><b>EE-010-004 / EE-010-014</b></p>
<p><b>Alle Kabel passen zu den monopolaren Elektroden/Instrumenten auf den Seiten 49 - 71 / 107</b>  <b>All cables fit with the electrodes/instruments on pages 49 - 71 / 107</b></p>	

**Bestell-Nr.**  
**Ordering no.**

<b>EE-010-001</b>	HF-Anschlusskabel, monopolar, Ø 4mm, Länge 3m, für Martin / Berchtold / Aesculap HF connection cable, monopolar, Ø 4mm, length 3m, for Martin / Berchtold / Aesculap
<b>EE-010-011</b>	HF-Anschlusskabel, monopolar, Ø 4mm, Länge 5m, für Martin / Berchtold / Aesculap HF connection cable, monopolar, Ø 4mm, length 5m, for Martin / Berchtold / Aesculap
<b>EE-010-002</b>	HF-Anschlusskabel, monopolar, Ø 4mm, Länge 3m, für Erbe ACC / ICC / VIO HF connection cable, monopolar, Ø 4mm, length 3m, for Erbe ACC / ICC / VIO
<b>EE-010-012</b>	HF-Anschlusskabel, monopolar, Ø 4mm, Länge 5m, für Erbe ACC / ICC / VIO HF connection cable, monopolar, Ø 4mm, length 5m, for Erbe ACC / ICC / VIO
<b>EE-010-003</b>	HF-Anschlusskabel, monopolar, Ø 4mm, Länge 3m, für Bovie / Valleylab / Conmed HF connection cable, monopolar, Ø 4mm, length 3m, for Bovie / Valleylab / Conmed
<b>EE-010-013</b>	HF-Anschlusskabel, monopolar, Ø 4mm, Länge 5m, für Bovie / Valleylab / Conmed HF connection cable, monopolar, Ø 4mm, length 5m, for Bovie / Valleylab / Conmed
<b>EE-010-004</b>	HF-Anschlusskabel, monopolar, Ø 4mm, Länge 3m, für Erbe T-Serie / Martin / Berchtold HF connection cable, monopolar, Ø 4mm, length 3m, for Erbe T-Series / Martin / Berchtold
<b>EE-010-014</b>	HF-Anschlusskabel, monopolar, Ø 4mm, Länge 5m, für Erbe T-Serie / Martin / Berchtold HF connection cable, monopolar, Ø 4mm, length 5m, for Erbe T-Series / Martin / Berchtold





Anschluss Flachstecker Instrumentenseite <i>Connection flat plug instrument side</i>	Anschluss Geräteseite <i>Connection unit side</i>
	 <p><b>EK-010-010 / EK-010-011</b></p>
	 <p><b>EK-010-012 / EK-010-013</b></p>
	 <p><b>EK-010-014 / EK-010-015</b></p>
	 <p><b>EK-010-016 / EK-010-017</b></p>
<p><b>Alle Kabel passen zu den monopolaren Elektroden/Instrumenten auf den Seiten 88 - 93 / 126 - 128</b> <b>All cables fit with the electrodes/instruments on pages 88 - 93 / 126 - 128</b></p>	

<b>Bestell-Nr.</b> <b>Ordering no.</b>	
<b>EK-010-010</b>	HF-Anschlusskabel, bipolar, Flachstecker, Länge 3m, für Martin / Berchtold / Aesculap <i>HF connection cable, bipolar, flat plug, length 3m, for Martin / Berchtold / Aesculap</i>
<b>EK-010-011</b>	HF-Anschlusskabel, bipolar, Flachstecker, Länge 5m, für Martin / Berchtold / Aesculap <i>HF connection cable, bipolar, flat plug, length 5m, for Martin / Berchtold / Aesculap</i>
<b>EK-010-012</b>	HF-Anschlusskabel, bipolar, Flachstecker, Länge 3m, für Erbe / Storz <i>HF connection cable, bipolar, flat plug, length 3m, for Erbe / Storz</i>
<b>EK-010-013</b>	HF-Anschlusskabel, bipolar, Flachstecker, Länge 5m, für Erbe / Storz <i>HF connection cable, bipolar, flat plug, length 5m, for Erbe / Storz</i>
<b>EK-010-014</b>	HF-Anschlusskabel, bipolar, Flachstecker, Länge 3m, für Valleylab / EMC <i>HF connection cable, bipolar, flat plug, length 3m, for Valleylab / EMC</i>
<b>EK-010-015</b>	HF-Anschlusskabel, bipolar, Flachstecker, Länge 5m, für Valleylab / EMC <i>HF connection cable, bipolar, flat plug, length 5m, for Valleylab / EMC</i>
<b>EK-010-016</b>	HF-Anschlusskabel, bipolar, Flachstecker, Länge 3m, Bananenstecker <i>HF connection cable, bipolar, flat plug, length 3m, banana plugs</i>
<b>EK-010-017</b>	HF-Anschlusskabel, bipolar, Flachstecker, Länge 5m, Bananenstecker <i>HF connection cable, bipolar, flat plug, length 5m, banana plugs</i>

Anschluss 2-Pin Stecker Instrumentenseite Connection 2-pin plug instrument side	Anschluss Geräteseite Connection unit side
	 <p><b>EK-010-030 / EK-010-031</b></p>
	 <p><b>EK-010-032 / EK-010-033</b></p>
	 <p><b>EK-010-034 / EK-010-035</b></p>
	 <p><b>EK-010-036 / EK-010-037</b></p>
<p><b>Alle Kabel passen zu den monopolaren Elektroden/Instrumenten auf den Seiten 89 - 91 / 126 - 128</b>  <b>All cables fit with the electrodes/instruments on pages 89 - 91 / 126 - 128</b></p>	

**Bestell-Nr.  
Ordering no.**

<b>EK-010-030</b>	HF-Anschlusskabel, bipolar, 2-Pin Stecker, Länge 3m, für Martin / Berchtold / Aesculap HF connection cable, bipolar, 2-pin plug, length 3m, for Martin / Berchtold / Aesculap
<b>EK-010-031</b>	HF-Anschlusskabel, bipolar, 2-Pin Stecker, Länge 5m, für Martin / Berchtold / Aesculap HF connection cable, bipolar, 2-pin plug, length 5m, for Martin / Berchtold / Aesculap
<b>EK-010-032</b>	HF-Anschlusskabel, bipolar, 2-Pin Stecker, Länge 3m, für Erbe / Storz HF connection cable, bipolar, 2-pin plug, length 3m, for Erbe / Storz
<b>EK-010-033</b>	HF-Anschlusskabel, bipolar, 2-Pin Stecker, Länge 5m, für Erbe / Storz HF connection cable, bipolar, 2-pin plug, length 5m, for Erbe / Storz
<b>EK-010-034</b>	HF-Anschlusskabel, bipolar, 2-Pin Stecker, Länge 3m, für Valleylab / EMC HF connection cable, bipolar, 2-pin plug, length 3m, for Valleylab / EMC
<b>EK-010-035</b>	HF-Anschlusskabel, bipolar, 2-Pin Stecker, Länge 5m, für Valleylab / EMC HF connection cable, bipolar, 2-pin plug, length 5m, for Valleylab / EMC
<b>EK-010-036</b>	HF-Anschlusskabel, bipolar, 2-Pin Stecker, Länge 3m, Bananenstecker HF connection cable, bipolar, 2-pin plug, length 3m, banana plugs
<b>EK-010-037</b>	HF-Anschlusskabel, bipolar, 2-Pin Stecker, Länge 5m, Bananenstecker HF connection cable, bipolar, 2-pin plug, length 5m, banana plugs

Anschluss Flachstecker Instrumentenseite <i>Connection flat plug instrument side</i>	Anschluss Geräteseite <i>Connection unit side</i>
	 <p><b>EK-010-060 / EK-010-061</b></p>
	 <p><b>EK-010-062 / EK-010-063</b></p>
	 <p><b>EK-010-064 / EK-010-065</b></p>
	 <p><b>EK-010-066 / EK-010-067</b></p>
<p><b>Alle Kabel passen zu den monopolaren Elektroden/Instrumenten auf den Seiten 94 und 95</b> <b>All cables fit with the electrodes/instruments on pages 94 and 95</b></p>	

<b>Bestell-Nr.</b> <b>Ordering no.</b>	
<b>EK-010-060</b>	HF-Anschlusskabel, bipolar, Flachstecker Vierkant, Länge 3m, für Martin / Berchtold <i>HF connection cable, bipolar, flat plug square, length 3m, for Martin / Berchtold</i>
<b>EK-010-061</b>	HF-Anschlusskabel, bipolar, Flachstecker Vierkant, Länge 5m, für Martin / Berchtold <i>HF connection cable, bipolar, flat plug square, length 5m, for Martin / Berchtold</i>
<b>EK-010-062</b>	HF-Anschlusskabel, bipolar, Flachstecker Vierkant, Länge 3m, für Erbe / Storz <i>HF connection cable, bipolar, flat plug square, length 3m, for Erbe / Storz</i>
<b>EK-010-063</b>	HF-Anschlusskabel, bipolar, Flachstecker Vierkant, Länge 5m, für Erbe / Storz <i>HF connection cable, bipolar, flat plug square, length 5m, for Erbe / Storz</i>
<b>EK-010-064</b>	HF-Anschlusskabel, bipolar, Flachstecker Vierkant, Länge 3m, für Valleylab <i>HF connection cable, bipolar, flat plug square, length 3m, for Valleylab</i>
<b>EK-010-065</b>	HF-Anschlusskabel, bipolar, Flachstecker Vierkant, Länge 5m, für Valleylab <i>HF connection cable, bipolar, flat plug square, length 5m, for Valleylab</i>
<b>EK-010-066</b>	HF-Anschlusskabel, bipolar, Flachstecker Vierkant, Länge 3m, Bananenstecker <i>HF connection cable, bipolar, flat plug square, length 3m, banana plugs</i>
<b>EK-010-067</b>	HF-Anschlusskabel, bipolar, Flachstecker Vierkant, Länge 5m, Bananenstecker <i>HF connection cable, bipolar, flat plug square, length 5m, banana plugs</i>



**Bestell-Nr.**  
**Ordering no.**

**EL-002-003** STEMA flexibles Haltearm-System  
STEMA flexible holding assistance system



**Bestell-Nr.**  
**Ordering no.**

**EL-002-004** STEMA Doppel-Haltearm-System  
*STEMA double stem holding assistance system*



**EL-002-031**



**EL-002-033**



**EL-002-034**



**EL-002-032**



**EL-002-035**

**Bestell-Nr.  
Ordering no.**

<b>EL-002-030</b>	STEMA flexibles Haltearm-System, komplett mit 1 Aufsatz <i>STEMA flexible holding assistance system, complete with 1 attachment</i>
<b>EL-002-031</b>	Grundelement für flexibles Haltearm-System <i>Basic element for flexible holding assistance system</i>
<b>EL-002-032</b>	Fixationselement (an OP-Tischschiene) für flexibles Haltearm-System <i>Fixation element (on OR table rail) for flexible holding assistance system</i>
<b>EL-002-033</b>	Halteelement (für Optiken, etc.) für flexibles Haltearm-System <i>Holding element (for scopes, etc.) for flexible holding assistance system</i>
<b>EL-002-034</b>	Halteelement (für Optiken, etc.) für flexibles Haltearm-System <i>Holding element (for scopes, etc.) for flexible holding assistance system</i>
<b>EL-002-035</b>	Halteelement (für Nasenspekulas, etc.) für flexibles Haltearm-System <i>Holding element (for nasal speculas, etc.) for flexible holding assistance system</i>

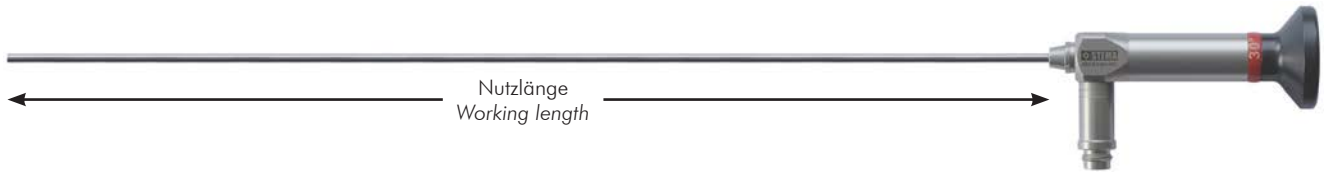

<b>Bestell-Nr.</b> <b>Ordering no.</b>	<b>Durchmesser</b> <b>Diameter</b>	<b>Blickrichtung</b> <b>Direction of view</b>	<b>Nutzlänge</b> <b>Working length</b>
<b>EA-000-001</b>	2.0mm	0°	200mm
<b>EA-000-002</b>	2.0mm	0°	300mm
<b>EA-001-001</b>	2.9mm	0°	300mm
<b>EA-001-002</b>	2.9mm	30°	300mm



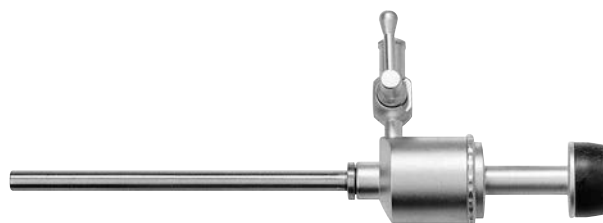

**Bestell-Nr.  
Ordering no.**

<b>EH-000-001</b>	Ø 2.5mm automatik Trokarhülse, Metallschaftrohr glatt Ø 2.5mm automatic trocar sleeve, metal tube smooth
<b>EH-000-101</b>	Ø 2.5mm automatik Trokarhülse, Metallschaftrohr glatt, <b>komplett</b> mit konischem Trokar Ø 2.5mm automatic trocar sleeve, metal tube smooth, <b>complete</b> with conical trocar
<b>EH-000-201</b>	Ø 2.5mm automatik Trokarhülse, Metallschaftrohr glatt, <b>komplett</b> mit dreikant Trokar Ø 2.5mm automatic trocar sleeve, metal tube smooth, <b>complete</b> with pyramidal trocar
<b>EH-005-001</b>	Ø 3.5mm automatik Trokarhülse, Metallschaftrohr glatt Ø 3.5mm automatic trocar sleeve, metal tube smooth
<b>EH-005-101</b>	Ø 3.5mm automatik Trokarhülse, Metallschaftrohr glatt, <b>komplett</b> mit konischem Trokar Ø 3.5mm automatic trocar sleeve, metal tube smooth, <b>complete</b> with conical trocar
<b>EH-005-201</b>	Ø 3.5mm automatik Trokarhülse, Metallschaftrohr glatt, <b>komplett</b> mit dreikant Trokar Ø 3.5mm automatic trocar sleeve, metal tube smooth, <b>complete</b> with pyramidal trocar

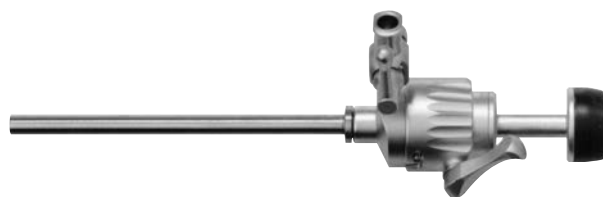

**Bestell-Nr.  
Ordering no.**

<b>EH-001-001</b>	Ø 3.5mm automatik Trokarhülse mit manueller Klappenöffnung, Metallschaftrohr glatt Ø 3.5mm automatic trocar sleeve with separate opening lever, metal tube smooth
<b>EH-001-101</b>	Ø 3.5mm automatik Trokarhülse mit manueller Klappenöffnung, Metallschaftrohr glatt, <b>komplett</b> mit konischem Trokar Ø 3.5mm automatic trocar sleeve with separate opening lever, metal tube smooth, <b>complete</b> with conical trocar
<b>EH-001-201</b>	Ø 3.5mm automatik Trokarhülse mit manueller Klappenöffnung, Metallschaftrohr glatt, <b>komplett</b> mit dreikant Trokar Ø 3.5mm automatic trocar sleeve with separate opening lever, metal tube smooth, <b>complete</b> with pyramidal trocar

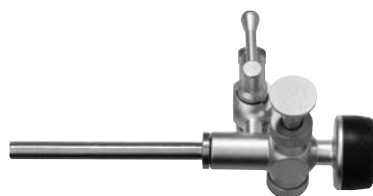

**Bestell-Nr.  
Ordering no.**

<b>EH-010-001</b>	Ø 3.0mm Trokarhülse mit Trompetenventil, Metallschaftrohr glatt Ø 3.0mm trocar sleeve with trumpet valve, metal tube smooth
<b>EH-010-101</b>	Ø 3.0mm Trokarhülse mit Trompetenventil, Metallschaftrohr glatt, <b>komplett</b> mit konischem Trokar Ø 3.0mm trocar sleeve with trumpet valve, metal tube smooth, <b>complete</b> with conical trocar
<b>EH-010-201</b>	Ø 3.0mm Trokarhülse mit Trompetenventil, Metallschaftrohr glatt, <b>komplett</b> mit dreikant Trokar Ø 3.0mm trocar sleeve with trumpet valve, metal tube smooth, <b>complete</b> with pyramidal trocar



**Bestell-Nr.**  
**Ordering no.**

<b>EJ-001-000</b>	Ø 2.5mm Trokar, dreikant Ø 2.5mm trocar, pyramidal
<b>EJ-001-001</b>	Ø 3.0mm Trokar, dreikant Ø 3.0mm trocar, pyramidal
<b>EJ-001-001-1</b>	Ø 3.5mm Trokar, dreikant Ø 3.5mm trocar, pyramidal



**Bestell-Nr.**  
**Ordering no.**

<b>EJ-002-000</b>	Ø 2.5mm Trokar, konisch Ø 2.5mm trocar, conical
<b>EJ-002-001</b>	Ø 3.0mm Trokar, konisch Ø 3.0mm trocar, conical
<b>EJ-002-001-1</b>	Ø 3.5mm Trokar, konisch Ø 3.5mm trocar, conical



**Bestell-Nr.**  
**Ordering no.**

<b>EH-025-001</b>	Ø 3.5mm Sicherheitstrokar, stumpf Ø 3.5mm safety trocar, blunt
-------------------	---



**Bestell-Nr.**  
**Ordering no.**

<b>EH-042-011</b>	Ø 2.0mm Taststab graduert, Arbeitslänge 330mm Ø 2.0mm palpation probe graduated, working length 330mm
<b>EH-042-012</b>	Ø 2.8mm Taststab graduert, Arbeitslänge 330mm Ø 2.8mm palpation probe graduated, working length 330mm
<b>EH-042-013</b>	Ø 2.8mm Taststab graduert, Arbeitslänge 250mm Ø 2.8mm palpation probe graduated, working length 250mm



**Bestell-Nr.  
 Ordering no.**

<b>EH-041-026</b>	Ø 2.8mm Injektionskanüle, Nadel Ø 1.2mm, Nadellänge 20mm, Arbeitslänge 250mm Ø 2.8mm injection cannula, needle Ø 1.2mm, needle length 20mm, working length 250mm
<b>EH-041-025</b>	Ø 2.8mm Injektionskanüle, Nadel Ø 1.2mm, Nadellänge 20mm, Arbeitslänge 330mm Ø 2.8mm injection cannula, needle Ø 1.2mm, needle length 20mm, working length 330mm



**Bestell-Nr.  
 Ordering no.**

<b>EH-038-001-25</b>	Ø 2.8mm Saug-Spülkanüle mit Schiebeventil, Rundlochsauger mit 8 Bohrungen, Arbeitslänge 250mm Ø 2.8mm suction-irrigation cannula with sliding valve, roundhole sucker with 8 drillings, working length 250mm
<b>EH-038-001</b>	Ø 2.8mm Saug-Spülkanüle mit Schiebeventil, Rundlochsauger mit 8 Bohrungen, Arbeitslänge 330mm Ø 2.8mm suction-irrigation cannula with sliding valve, roundhole sucker with 8 drillings, working length 330mm



**Bestell-Nr.  
 Ordering no.**

<b>EH-038-002-25</b>	Ø 2.8mm Saug-Spülkanüle mit Schlauchanschluss, Rundlochsauger mit 8 Bohrungen, Arbeitslänge 250mm Ø 2.8mm suction-irrigation cannula with tube connection, roundhole sucker with 8 drillings, working length 250mm
<b>EH-038-002</b>	Ø 2.8mm Saug-Spülkanüle mit Schlauchanschluss, Rundlochsauger mit 8 Bohrungen, Arbeitslänge 330mm Ø 2.8mm suction-irrigation cannula with tube connection, roundhole sucker with 8 drillings, working length 330mm

**Bestell-Nr.  
 Ordering no.**

Ø 10mm Saug-Spül Handgriff mit großem Schlauchanschluss und seitlichem Schlauchanschluss Ø 10mm suction-irrigation handle with large tube connection and sidewise tube connection	<b>EH-035-016</b>
Ø 10mm Saug-Spül Handgriff mit großem Schlauchanschluss und seitlichem Schlauchanschluss <b>komplett</b> inkl. 3.5mm Rohr, AL 330mm Ø 10mm suction-irrigation handle with large tube connection and sidewise tube connection <b>complete</b> incl. 3.5mm tube, WL 330mm	<b>EH-038-003</b>



**Bestell-Nr.  
 Ordering no.**

<b>EH-038-033</b>	Ø 3.5mm Saug-Spülrohr mit 8 Bohrungen, für 10mm Saug-Spül Handgriff, Arbeitslänge 240mm Ø 3.5mm suction-irrigation tube with 8 drillings, for 10 mm suction-irrigation handle, working length 240mm
-------------------	--



<b>Bestell-Nr.</b> <b>Ordering no.</b>		
<b>EE-000-001-20</b>	Ø 2.8mm monopolare Knopfelektrode, <b>200mm</b> Ø 2.8mm monopolar button electrode, <b>200mm</b>	
<b>EE-000-001-25</b>	Ø 2.8mm monopolare Knopfelektrode, <b>250mm</b> Ø 2.8mm monopolar button electrode, <b>250mm</b>	
<b>EE-000-001</b>	Ø 2.8mm monopolare Knopfelektrode, <b>330mm</b> Ø 2.8mm monopolar button electrode, <b>330mm</b>	
<b>EE-000-002-20</b>	Ø 2.8mm monopolare J-Hakenelektrode, <b>200mm</b> Ø 2.8mm monopolar J-hook electrode, <b>200mm</b>	
<b>EE-000-002-25</b>	Ø 2.8mm monopolare J-Hakenelektrode, <b>250mm</b> Ø 2.8mm monopolar J-hook electrode, <b>250mm</b>	
<b>EE-000-002</b>	Ø 2.8mm monopolare J-Hakenelektrode, <b>330mm</b> Ø 2.8mm monopolar J-hook electrode, <b>330mm</b>	
<b>EE-000-003-20</b>	Ø 2.8mm monopolare 90° Hakenelektrode, <b>200mm</b> Ø 2.8mm monopolar 90° hook electrode, <b>200mm</b>	
<b>EE-000-003-25</b>	Ø 2.8mm monopolare 90° Hakenelektrode, <b>250mm</b> Ø 2.8mm monopolar 90° hook electrode, <b>250mm</b>	
<b>EE-000-003</b>	Ø 2.8mm monopolare 90° Hakenelektrode, <b>330mm</b> Ø 2.8mm monopolar 90° hook electrode, <b>330mm</b>	
<b>EE-000-005-20</b>	Ø 2.8mm monopolare Spatelektrode, <b>200mm</b> Ø 2.8mm monopolar spatula electrode, <b>200mm</b>	
<b>EE-000-005-25</b>	Ø 2.8mm monopolare Spatelektrode, <b>250mm</b> Ø 2.8mm monopolar spatula electrode, <b>250mm</b>	
<b>EE-000-005</b>	Ø 2.8mm monopolare Spatelektrode, <b>330mm</b> Ø 2.8mm monopolar spatula electrode, <b>330mm</b>	
<b>EE-000-006-20</b>	Ø 2.8mm monopolare Nadelelektrode, <b>200mm</b> Ø 2.8mm monopolar needle electrode, <b>200mm</b>	
<b>EE-000-006-25</b>	Ø 2.8mm monopolare Nadelelektrode, <b>250mm</b> Ø 2.8mm monopolar needle electrode, <b>250mm</b>	
<b>EE-000-006</b>	Ø 2.8mm monopolare Nadelelektrode, <b>330mm</b> Ø 2.8mm monopolar needle electrode, <b>330mm</b>	



**Bestell-Nr.  
Ordering no.**

<b>EG-003-011</b>	Ø 3mm axialer Nadelhalter, gerade, Axialgriff, TC-Einsatz, Arbeitslänge 280mm Ø 3mm axial needleholder, straight, axial handle, TC-insert, working length 280mm	
<b>EG-003-012</b>	Ø 3mm axialer Nadelhalter, links gebogen, Axialgriff, TC-Einsatz, Arbeitslänge 280mm Ø 3mm axial needleholder, curved left, axial handle, TC-insert, working length 280mm	
<b>EG-003-013</b>	Ø 3mm axialer Nadelhalter, rechts gebogen, Axialgriff, TC-Einsatz, Arbeitslänge 280mm Ø 3mm axial needleholder, curved right, axial handle, TC-insert, working length 280mm	



**Bestell-Nr.  
Ordering no.**

<b>EG-003-031</b>	Ø 3mm Nadelhalter, gerade, Ringgriff, TC-Einsatz, Arbeitslänge 280mm Ø 3mm needleholder, straight, ring handle, TC-insert, working length 280mm	
<b>EG-003-032</b>	Ø 3mm Nadelhalter, links gebogen, Ringgriff, TC-Einsatz, Arbeitslänge 280mm Ø 3mm needleholder, curved left, ring handle, TC-insert, working length 280mm	
<b>EG-003-034</b>	Ø 3mm Nadelhalter, rechts gebogen, Ringgriff, TC-Einsatz, Arbeitslänge 280mm Ø 3mm needleholder, curved right, ring handle, TC-insert, working length 280mm	



**Bestell-Nr.**  
**Ordering no.**

<b>EC-002-023</b>	<p>Ø 2mm Schere, gerade, gezahnt, einfachbeweglich, Arbeitslänge 240mm          Ø 2mm scissors, straight, serrated, single action, working length 240mm</p>	
<b>EC-002-253</b>	<p>Ø 2mm Löffel-Probeexzisionszange, einfachbeweglich, Arbeitslänge 240mm          Ø 2mm spoon biopsy forceps, single action, working length 240mm</p>	
<b>ED-002-203</b>	<p>Ø 2mm Alligator Fasszange, einfachbeweglich, Arbeitslänge 240mm          Ø 2mm Alligator grasping forceps, single action, working length 240mm</p>	
<b>ED-002-263</b>	<p>Ø 2mm Punch, durchschneidend, einfachbeweglich, Arbeitslänge 240mm          Ø 2mm punch, cutting through, single action, working length 240mm</p>	



**Bestell-Nr.**  
**Ordering no.**

**EC-001-003-25** Ø 5mm isolierter Schaft für modulares System, 250mm  
Ø 5mm insulated shaft for modular system, 250mm

**Hinweis:** Alle Instrumenteneinsätze und Schäfte können mit den nachfolgenden Griffen kombiniert werden.  
Bitte kontaktieren Sie uns.

**Advice:** All instrument inserts and sheaths can be combined with the following handles.  
Please kindly contact us.



**Bestell-Nr.**  
**Ordering no.**

**EC-001-001**

STEMA ergonomischer Laparoskopie  
Handgriff mit HF-Anschluss  
*STEMA ergonomic laparoscopic handle  
with HF-connection*



**Bestell-Nr.**  
**Ordering no.**

**ED-001-001**

STEMA ergonomischer Laparoskopie  
Handgriff mit Sperre  
*STEMA ergonomic laparoscopic handle  
with ratchet*





**Bestell-Nr.**  
**Ordering no.**

**EC-001-002**

Standard Laparoskopie Handgriff mit  
HF-Anschluss, isoliert, ohne Sperre  
*Standard laparoscopic handle with  
HF-connection, insulated, without ratchet*



**Bestell-Nr.**  
**Ordering no.**

**ED-001-005**

Standard Laparoskopie Handgriff mit  
HF-Anschluss, isoliert, mit Sperre  
*Standard laparoscopic handle with  
HF-connection, insulated, with ratchet*



**Bestell-Nr.**  
**Ordering no.**

**ED-001-003**

Standard Laparoskopie Handgriff, nicht  
isoliert, ohne Sperre  
*Standard laparoscopic handle, not  
insulated, without ratchet*



**Bestell-Nr.**  
**Ordering no.**

**ED-001-002**

Standard Laparoskopie Handgriff, nicht  
isoliert, mit Sperre  
*Standard laparoscopic handle, not  
insulated, with ratchet*



**Bestell-Nr.**  
**Ordering no.**

**ED-001-006**

Standard Laparoskopie Handgriff,  
isoliert, mit französischer Sperre  
*Standard laparoscopic handle,  
insulated, with french ratchet*



**Bestell-Nr.**  
**Ordering no.**

**ED-001-009**

STEMA ergonomischer Laparoskopie  
Handgriff mit französischer Sperre  
*STEMA ergonomic laparoscopic  
handle with french ratchet*



**Bestell-Nr.**  
**Ordering no.**

**ED-001-004**













Standard Laparoskopie Handgriff mit  
Feder, nicht isoliert  
*Standard laparoscopic handle with  
spring, not insulated*















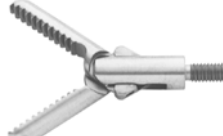
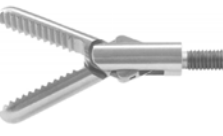

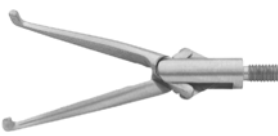

**Bestell-Nr.**  
**Ordering no.**



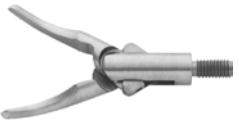





**ED-001-007**







Axialer Ringgriff für modulares System,  
mit Sperre  
*Axial ring handle used for modular  
system, with ratchet*











5mm		Einsatz allein Insert only	5mm	Instrument komplett Instrument complete
				
250mm	Maul Tip	Bezeichnung Description	250mm	
EC-005-041-25		<b>Schere</b> , gerade, doppelbeweglich <b>Scissors</b> , straight, double action	EC-005-043-25	
EC-005-371-25		<b>Schere</b> , gerade, gezahnt, doppelbeweglich <b>Scissors</b> , straight, serrated, double action	EC-005-373-25	
EC-005-021-25		<b>Peritonealschere</b> , gezahnt, einfachbeweglich <b>Peritoneal scissors</b> , serrated, single action	EC-005-023-25	
EC-005-031-25		<b>Hakenschere</b> , einfachbeweglich <b>Hook scissors</b> , single action	EC-005-033-25	
EC-005-051-25		<b>Mikroschere</b> , gerade, einfachweglich <b>Micro scissors</b> , straight, single action	EC-005-053-25	
EC-005-351-25		<b>Mikroschere</b> , gebogen, sehr fein, einfachweglich <b>Micro scissors</b> , curved, very delicate, single action	EC-005-353-25	
EC-005-001-25		<b>Metzenbaumschere</b> , gebogen, kurz, doppelbeweglich <b>Metzenbaum scissors</b> , curved, short, double action	EC-005-003-25	
EC-005-011-25		<b>Metzenbaumschere</b> , gebogen, lang, doppelbeweglich <b>Metzenbaum scissors</b> , curved, long, double action	EC-005-013-25	
EC-005-061-25		<b>Metzenbaumschere</b> , gebogen, gezahnt, doppelbeweglich <b>Metzenbaum scissors</b> , curved, serrated, double action	EC-005-063-25	
EC-005-311-25		<b>Mini-Metzenbaumschere</b> , gebogen, 5 auf 4mm, doppelbeweglich <b>Mini-Metzenbaum scissors</b> , curved, 5 to 4mm, double action	EC-005-313-25	

5mm Einsatz allein Insert only		5mm Instrument komplett Instrument complete	
			
250mm	Maul Tip	Bezeichnung Description	250mm
EC-005-111-25		<b>Präparier- und Faßzange,</b> gefenestert, doppelbeweglich <b>Dissecting and grasping</b> <b>forceps, fenestrated, double action</b>	EC-005-113-25
EC-005-391-25		<b>Präparier- und Faßzange,</b> gefenestert, 25mm lang, doppelbeweglich <b>Dissecting and grasping</b> <b>forceps, fenestrated, 25mm long,</b> <b>double action</b>	EC-005-393-25
EC-005-151-25		<b>Präparier- und Faßzange,</b> doppelbeweglich <b>Dissecting and grasping</b> <b>forceps, double action</b>	EC-005-153-25
EC-005-161-25		<b>Präparier- und Faßzange,</b> stumpf, doppelbeweglich <b>Dissecting and grasping</b> <b>forceps, blunt, double action</b>	EC-005-163-25
EC-005-211-25		<b>Präparier- und Faßzange,</b> stumpf mit Löffel, doppelbeweglich <b>Dissecting and grasping</b> <b>forceps, blunt with spoon,</b> <b>double action</b>	EC-005-213-25
EC-005-171-25		<b>Mixer Präparier- und Faßzange,</b> doppelbeweglich <b>Mixer dissecting and grasping</b> <b>forceps, double action</b>	EC-005-173-25
EC-005-361-25		<b>Mixer Präparier- und Faßzange,</b> lang und dünn, doppelbeweglich <b>Mixer dissecting and grasping</b> <b>forceps, long and thin, double action</b>	EC-005-363-25
EC-005-421-25		<b>90° Mixer Präparier- und Faßzange,</b> doppelbeweglich <b>90° Mixer dissecting and grasping</b> <b>forceps, double action</b>	EC-005-423-25

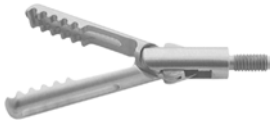
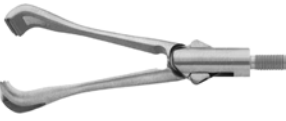
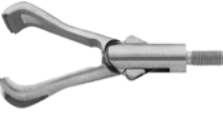



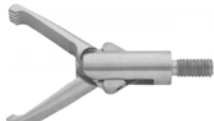



5mm Einsatz allein Insert only		5mm Instrument komplett Instrument complete	
			
250mm	Maul Tip	Bezeichnung Description	250mm
EC-005-181-25		<b>Kelly</b> Präparier- und Faßzange, doppelbeweglich <b>Kelly</b> dissecting and grasping forceps, double action	EC-005-183-25
EC-005-431-25		<b>Präparier- und Faßzange</b> , atraumatisch, gefenestert, doppelbeweglich <b>Dissecting and grasping</b> <b>forceps</b> , atraumatic, fenestrated, double action	EC-005-433-25
EC-005-121-25		<b>Maryland</b> Dissektionszange, doppelbeweglich <b>Maryland</b> dissecting forceps, double action	EC-005-123-25
EC-005-411-25		<b>Maryland</b> Dissektionszange, kurz, doppelbeweglich <b>Maryland</b> dissecting forceps, short, double action	EC-005-413-25
EC-005-271-25		<b>Maryland</b> Dissektionszange, kreuzgezahnt, doppelbeweglich <b>Maryland</b> dissecting forceps, cross serrated, double action	EC-005-273-25
EC-005-131-25		<b>Dolphin</b> Dissektionszange, doppelbeweglich <b>Dolphin</b> dissecting forceps, double action	EC-005-133-25
EC-005-141-25		<b>Dolphin</b> Dissektionszange, lang, doppelbeweglich <b>Dolphin</b> dissecting forceps, long, double action	EC-005-143-25







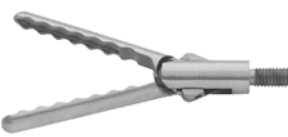

5mm Einsatz allein Insert only		5mm Instrument komplett Instrument complete	
			
250mm	Maul Tip	Bezeichnung Description	250mm
<b>EC-005-231-25</b>		<b>Slim</b> Dissektionszange, einfachbeweglich <b>Slim</b> dissecting forceps, single action	<b>EC-005-233-25</b>
<b>EC-005-241-25</b>		<b>Dissektionszange</b> , spitz mit Löffel, doppelbeweglich <b>Dissecting forceps</b> , pointed with spoon, double action	<b>EC-005-243-25</b>
<b>EC-005-301-25</b>		<b>Reddick-Olsen</b> Dissektionszange, doppelbeweglich <b>Reddick-Olsen</b> dissecting forceps, double action	<b>EC-005-303-25</b>
<b>EC-005-321-25</b>		<b>Dissektionszange</b> , gezahnt, stark gebogen, einfachbeweglich <b>Dissecting forceps</b> , serrated, strong curved, single action	<b>EC-005-323-25</b>
<b>EC-005-331-25</b>		<b>Dissektionszange</b> , fein gezahnt, gerade, einfachbeweglich <b>Dissecting forceps</b> , fine serrated, straight, single action	<b>EC-005-333-25</b>
<b>EC-005-341-25</b>		<b>Dissektionszange</b> , fein gezahnt, leicht gebogen, einfachbeweglich <b>Dissecting forceps</b> , fine serrated, slightly curved, single action	<b>EC-005-343-25</b>



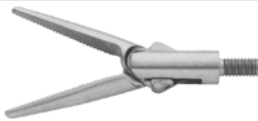

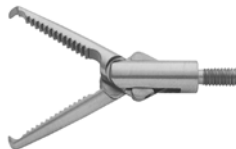

5mm Einsatz allein Insert only		5mm Instrument komplett Instrument complete	
250mm	Maul Tip	Bezeichnung Description	250mm
<b>EC-005-191-25</b>		<b>Löffel</b> Probeexzisionszange, doppelbeweglich <b>Spoon</b> biopsy forceps, double action	<b>EC-005-193-25</b>
<b>EC-005-201-25</b>		<b>Löffel</b> Probeexzisionszange, mit Dorn, doppelbeweglich <b>Spoon</b> biopsy forceps, with spike, double action	<b>EC-005-203-25</b>
<b>EC-005-251-25</b>		<b>Löffel</b> Probeexzisionszange, einfachbeweglich <b>Spoon</b> biopsy forceps, single action	<b>EC-005-253-25</b>
<b>EC-005-261-25</b>		<b>Löffel</b> Probeexzisionszange, mit Dorn, einfachbeweglich <b>Spoon</b> biopsy forceps, with spike, single action	<b>EC-005-263-25</b>
<b>EC-005-221-25</b>		<b>Blakesly</b> Probeexzisionszange, doppelbeweglich <b>Blakesly</b> biopsy forceps, double action	<b>EC-005-223-25</b>
<b>EC-005-401-25</b>		<b>Mikrobiopsielöffel</b> , einfachbeweglich <b>Micro biopsy forceps</b> , single action	<b>EC-005-403-25</b>

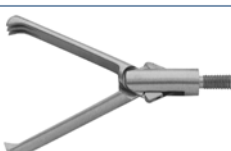

5mm Einsatz allein Insert only		5mm Instrument komplett Instrument complete	
250mm	Maul Tip	Bezeichnung Description	250mm
		<b>Fundus</b> Fassungseinsatz, doppelbeweglich <b>Fundus</b> grasping forceps, double action	
<b>ED-005-011-25</b>		<b>Cobra</b> Fassungseinsatz, 2 x 3 Zähne, doppelbeweglich <b>Cobra</b> grasping forceps, 2 x 3 teeth double action	<b>ED-005-013-25</b>
<b>ED-005-021-25</b>		<b>Endo-Clinch</b> Fassungseinsatz, gefenestert, doppelbeweglich <b>Endo-Clinch</b> grasping forceps, fenestrated, double action	<b>ED-005-023-25</b>
<b>ED-005-041-25</b>		<b>Babcock</b> Fassungseinsatz, doppelbeweglich <b>Babcock</b> grasping forceps, double action	<b>ED-005-043-25</b>
<b>ED-005-051-25</b>		<b>Babcock</b> Fassungseinsatz, kurz, doppelbeweglich <b>Babcock</b> grasping forceps, short, double action	<b>ED-005-053-25</b>
<b>ED-005-371-25</b>		<b>DeBakey</b> Fassungseinsatz, doppelbeweglich <b>DeBakey</b> grasping forceps, double action	<b>ED-005-373-25</b>
<b>ED-005-081-25</b>		<b>DeBakey-Maryland</b> Fassungseinsatz, atraumatisch, doppelbeweglich <b>DeBakey-Maryland</b> grasping forceps, atraumatic, double action	<b>ED-005-083-25</b>
<b>ED-005-331-25</b>		<b>Allis</b> Fassungseinsatz, doppelbeweglich <b>Allis</b> grasping forceps, double action	<b>ED-005-103-25</b>
<b>ED-005-101-25</b>		<b>Allis</b> Fassungseinsatz, 3 x 4 Zähne, atraumatisch, doppelbeweglich <b>Allis</b> grasping forceps, 3 x 4 teeth, atraumatic, double action	<b>ED-005-363-25</b>
<b>ED-005-361-25</b>		<b>Allis</b> Fassungseinsatz, einfachbeweglich <b>Allis</b> grasping forceps, single action	<b>ED-005-193-25</b>
<b>ED-005-191-25</b>			

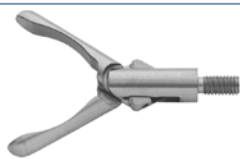
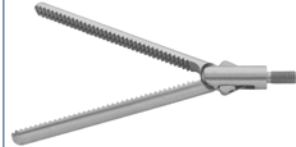











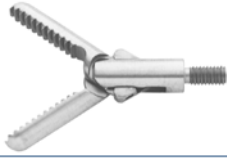

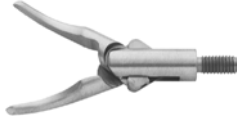
5mm Einsatz allein Insert only		5mm Instrument komplett Instrument complete	
250mm	Maul Tip	Bezeichnung Description	250mm
ED-005-031-25		<b>Alligator</b> Fass- und Probe- exzisionszange, doppelbeweglich <b>Alligator</b> grasping and biopsy forceps, double action	ED-005-033-25
ED-005-201-25		<b>Alligator</b> Fasszange, doppelbeweglich <b>Alligator</b> grasping forceps, double action	ED-005-203-25
ED-005-381-25		<b>Alligator</b> Fasszange, einfachbeweglich <b>Alligator</b> grasping forceps, single action	ED-005-383-25
ED-005-311-25		<b>Duckbill</b> Fasszange, kurz, gefenestert, einfachbeweglich <b>Duckbill</b> grasping forceps, short, fenestrated, single action	ED-005-313-25
ED-005-171-25		<b>Duckbill</b> Fasszange, 22mm, gefenestert, einfachbeweglich <b>Duckbill</b> grasping forceps, 22mm, fenestrated, single action	ED-005-173-25
ED-005-321-25		<b>Duckbill</b> Fasszange, 38mm, gefenestert, einfachbeweglich <b>Duckbill</b> grasping forceps, 38mm, fenestrated, single action	ED-005-323-25
ED-005-431-25		<b>Hunter</b> Fasszange, gefenestert, doppelbeweglich <b>Hunter</b> grasping forceps, fenestrated, double action	ED-005-433-25
ED-005-061-25		<b>Bowel</b> Fasszange, atraumatisch, doppelbeweglich <b>Bowel</b> grasping forceps, atraumatic, double action	ED-005-063-25
ED-005-181-25		<b>Wave</b> Fasszange, atraumatisch, einfachbeweglich <b>Wave</b> grasping forceps, atraumatic, single action	ED-005-183-25

5mm Einsatz allein Insert only		5mm Instrument komplett Instrument complete	
			
250mm	Maul Tip	Bezeichnung Description	250mm
<b>ED-005-351-25</b>		<b>Glassmann</b> Fasszange, atraumatisch, doppelbeweglich <b>Glassmann</b> grasping forceps, atraumatic, double action	<b>ED-005-353-25</b>
<b>ED-005-071-25</b>		<b>Slim</b> Fasszange, atraumatisch, doppelbeweglich <b>Slim</b> grasping forceps, atraumatic, double action	<b>ED-005-073-25</b>
<b>ED-005-421-25</b>		<b>Tenaculum</b> Fasszange, doppelbeweglich <b>Tenaculum</b> grasping forceps, double action	<b>ED-005-423-25</b>
<b>ED-005-211-25</b>		<b>Fasszange</b> , 1x2 Zähne, doppelbeweglich <b>Grasping forceps</b> , 1x2 teeth, double action	<b>ED-005-213-25</b>
<b>ED-005-281-25</b>		<b>Fasszange</b> , gewellt, 2x3 Zähne, einfachbeweglich <b>Grasping forceps</b> , wavy, 2x3 teeth, single action	<b>ED-005-283-25</b>
<b>ED-005-341-25</b>		<b>Fasszange</b> , scharf, atraumatisch, einfachbeweglich <b>Grasping forceps</b> , sharp, atraumatic, single action	<b>ED-005-343-25</b>
<b>ED-005-161-25</b>		<b>Krallengreifer</b> , einfachbeweglich <b>Claw forceps</b> , single action	<b>ED-005-163-25</b>
<b>ED-005-391-25</b>		<b>Krallengreifer</b> , doppelbeweglich <b>Claw forceps</b> , double action	<b>ED-005-393-25</b>

5mm		Einsatz allein Insert only	5mm		Instrument komplett Instrument complete
					
250mm	Maul Tip	Bezeichnung Description	250mm		
<b>ED-005-091-25</b>		<b>Bowel</b> Darmfasszange, doppelbeweglich <b>Bowel</b> intestinal grasping forceps, double action	<b>ED-005-093-25</b>		
<b>ED-005-111-25</b>		<b>Bowel</b> Darmfasszange, doppelbeweglich <b>Bowel</b> intestinal grasping forceps, double action	<b>ED-005-113-25</b>		
<b>ED-005-151-25</b>		<b>Dorsey</b> Darmfasszange, doppelbeweglich <b>Dorsey</b> intestinal grasping forceps, double action	<b>ED-005-153-25</b>		
<b>ED-005-401-25</b>		<b>Satinsky</b> Klemme, atraumatisch einfachbeweglich <b>Satinsky</b> clamp, atraumatic, single action	<b>ED-005-403-25</b>		
<b>ED-005-411-25</b>		<b>Satinsky</b> Klemme, atraumatisch einfachbeweglich <b>Satinsky</b> clamp, atraumatic, single action	<b>ED-005-413-25</b>		
<b>ED-005-261-25</b>		<b>Punch</b> durchschneidend, einfachbeweglich <b>Punch</b> cutting through, single action	<b>ED-005-263-25</b>		
<b>ED-005-451-25</b>		<b>Punch</b> durchschneidend, hakenförmig, einfachbeweglich <b>Punch</b> cutting through, hook shape, single action	<b>ED-005-453-25</b>		

3mm Einsatz mit Schaft allein <i>Insert with sheath only</i>			3mm Instrument komplett <i>Instrument complete</i>		
280mm	200mm	Maul Tip	Bezeichnung Description	280mm	200mm
<b>EC-003-001</b>	<b>EC-003-001-20</b>		<b>Metzenbaumschere</b> , gebogen, kurz, doppelbeweglich <b>Metzenbaum scissors</b> , curved, short, double action	<b>EC-003-003</b>	<b>EC-003-003-20</b>
<b>EC-003-031</b>	<b>EC-003-031-20</b>		<b>Hakenschere</b> , einfachbeweglich <b>Hook scissors</b> , single action	<b>EC-003-033</b>	<b>EC-003-033-20</b>
<b>EC-003-041</b>	<b>EC-003-041-20</b>		<b>Schere</b> , gerade, doppelbeweglich <b>Scissors</b> , straight, double action	<b>EC-003-043</b>	<b>EC-003-043-20</b>

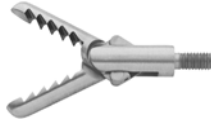
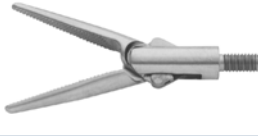
3mm Einsatz mit Schaft allein <i>Insert with sheath only</i>			3mm Instrument komplett <i>Instrument complete</i>		
					
280mm	200mm	Maul Tip	Bezeichnung Description	280mm	200mm
EC-003-121	EC-003-121-20		<b>Maryland</b> Dissektionszange, doppelbeweglich <b>Maryland</b> dissecting forceps, double action	EC-003-123	EC-003-123-20
EC-003-151	EC-003-151-20		<b>Präparier- und Faßzange</b> , doppelbeweglich <b>Dissecting and grasping</b> forceps, double action	EC-003-153	EC-003-153-20
EC-003-111	EC-003-111-20		<b>Präparier- und Faßzange</b> , gefenestert, doppelbeweglich <b>Dissecting and grasping</b> forceps, fenestrated, double action	EC-003-113	EC-003-113-20
EC-003-181	EC-003-181-20		<b>Kelly</b> Präparier- und Faßzange, doppelbeweglich <b>Kelly</b> dissecting and grasping forceps, double action	EC-003-183	EC-003-183-20
EC-003-191	EC-003-191-20		<b>Löffel</b> Probeexzisionszange, doppel- beweglich <b>Spoon</b> biopsy forceps, double action	EC-003-193	EC-003-193-20

3mm Einsatz allein Insert only			3mm Instrument komplett Instrument complete		
280mm	200mm	Maul Tip	Bezeichnung Description	280mm	200mm
					
<b>ED-003-011</b>	<b>ED-003-011-20</b>		<b>Fundus</b> Faszange, doppelbeweglich <b>Fundus</b> grasping forceps, double action	<b>ED-003-013</b>	<b>ED-003-013-20</b>
<b>ED-003-021</b>	<b>ED-003-021-20</b>		<b>Cobra</b> Faszange, 2 x 3 Zähne, doppelbeweglich <b>Cobra</b> grasping forceps, 2 x 3 teeth, double action	<b>ED-003-023</b>	<b>ED-003-023-20</b>
<b>ED-003-031</b>	<b>ED-003-031-20</b>		<b>Alligator</b> Fass- und Probe- exzisionszange, doppelbeweglich <b>Alligator</b> grasping and biopsy forceps, double action	<b>ED-003-033</b>	<b>ED-003-033-20</b>
<b>ED-003-201</b>	<b>ED-003-201-20</b>		<b>Alligator</b> Faszange, doppelbeweglich <b>Alligator</b> grasping forceps, double action	<b>ED-003-203</b>	<b>ED-003-203-20</b>
<b>ED-003-071</b>	<b>ED-003-071-20</b>		<b>Slim</b> Faszange, atraumatisch, doppelbeweglich <b>Slim</b> grasping forceps, atraumatic, double action	<b>ED-003-073</b>	<b>ED-003-073-20</b>
<b>ED-003-051</b>	<b>ED-003-051-20</b>		<b>Babcock</b> Faszange, kurz, doppelbeweglich <b>Babcock</b> grasping forceps, short, double action	<b>ED-003-053</b>	<b>ED-003-053-20</b>



**Bestell-Nr.  
Ordering no.**

**EK-006-001-20** 3mm bipolare Koagulationszange, zerlegbar, **komplett mit Ringgriff** (ohne Einsatz), 200mm  
3mm bipolar coagulation forceps, detachable, **complete with ring handle** (without insert), 200mm



**EK-006-001** 3mm bipolare Koagulationszange, zerlegbar, **komplett mit Ringgriff** (ohne Einsatz), 340mm  
3mm bipolar coagulation forceps, detachable, **complete with ring handle** (without insert), 340mm





**Bestell-Nr.  
Ordering no.**

**EK-007-001-20** 3mm bipolare Koagulationszange, zerlegbar, **komplett mit Standardgriff** (ohne Einsatz), 200mm  
3mm bipolar coagulation forceps, detachable, **complete with standard handle** (without insert), 200mm

**EK-007-001** 3mm bipolare Koagulationszange, zerlegbar, **komplett mit Standardgriff** (ohne Einsatz), 340mm  
3mm bipolar coagulation forceps, detachable, **complete with standard handle** (without insert), 340mm

Einsatz allein <i>Insert only</i>			Instrument komplett <i>Instrument complete</i>		
200mm	340mm	Maul Tip	Bezeichnung <i>Description</i>	200mm	340mm
<b>EK-008-010-20</b>	<b>EK-008-010</b>		<b>Tubenfasszangenelektrode,</b> gewellter Steg <b>Tubal grasping forceps electrode, rippled bar</b>	<b>EK-006-010-20</b>	<b>EK-006-010</b>
<b>EK-008-011-20</b>	<b>EK-008-011</b>		<b>Pinzettenelektrode,</b> 1mm Spitze <b>Fluted bit electrode,</b> 1mm tip	<b>EK-006-011-20</b>	<b>EK-006-011</b>

Einsatz allein <i>Insert only</i>			Instrument komplett <i>Instrument complete</i>		
200mm	340mm	Maul Tip	Bezeichnung <i>Description</i>	200mm	340mm
<b>EK-008-010-20</b>	<b>EK-008-010</b>		<b>Tubenfasszangenelektrode,</b> gewellter Steg <b>Tubal grasping forceps electrode, rippled bar</b>	<b>EK-007-010-20</b>	<b>EK-007-010</b>
<b>EK-008-011-20</b>	<b>EK-008-011</b>		<b>Pinzettenelektrode,</b> 1mm Spitze <b>Fluted bit electrode,</b> 1mm tip	<b>EK-007-011-20</b>	<b>EK-007-011</b>

**Bestell-Nr.**  
**Ordering no.**

**EK-010-008** Adapter für 2-Pin Stecker  
*Adapter for 2-pin plug*



**EK-010-009** Adapter für Flachstecker-Bipolarkabel  
*Adapter for flat plug bipolar cable*







**Bestell-Nr.**  
**Ordering no.**

**EK-001-007**

Ringgriff für zerlegbare bipolare  
Koagulationszangen  
*Ring handle for detachable bipolar  
coagulation forceps*

**Bestell-Nr.**  
**Ordering no.**

**EK-002-008**

Standardgriff für zerlegbare bipolare  
Koagulationszangen  
*Standard handle for detachable bipolar  
coagulation forceps*



**Bestell-Nr.**  
**Ordering no.**

**EK-001-003-20**

Innenrohr für zerlegbare Koagulationszange, 200mm  
*Inner sheath for detachable coagulation forceps, 200mm*

**EK-001-003-25**

Innenrohr für zerlegbare Koagulationszange, 250mm  
*Inner sheath for detachable coagulation forceps, 250mm*













**Bestell-Nr.**  
**Ordering no.**

**EK-001-004-20**

Ø 5mm Außenrohr für zerlegbare Koagulationszangen, 200mm  
*Ø 5mm outer sheath for detachable coagulation forceps, 200mm*

**EK-001-004-25**

Ø 5mm Außenrohr für zerlegbare Koagulationszangen, 250mm  
*Ø 5mm outer sheath for detachable coagulation forceps, 250mm*

Einsatz allein <i>Insert only</i>			Instrument komplett <i>Instrument complete</i>		
					
200mm	250mm	Maul Tip	Bezeichnung Description	200mm	250mm
EK-005-010-20	EK-005-010-25		<b>Tubenfasszangenelektrode,</b> gewellter Steg <b>Tubal grasping forceps</b> <b>electrode, rippled bar</b>	EK-001-010-20	EK-001-010-25
EK-005-011-20	EK-005-011-25		<b>Pinzettenelektrode,</b> 1mm Spitze <b>Fluted bit electrode,</b> 1mm tip	EK-001-011-20	EK-001-011-25
EK-005-012-20	EK-005-012-25		<b>Kleppingerelektrode,</b> gerieft <b>Kleppinger electrode,</b> serrated	EK-001-012-20	EK-001-012-25
EK-005-013-20	EK-005-013-25		<b>Plattenelektrode,</b> 3mm <b>Plate electrode,</b> 3mm	EK-001-013-20	EK-001-013-25
EK-005-014-20	EK-005-014-25		<b>Maryland</b> Dissektionslektrode, gebogen <b>Maryland</b> dissecting electrode, curved	EK-001-014-20	EK-001-014-25
EK-005-015-20	EK-005-015-25		<b>Scherelektrode,</b> gebogen <b>Scissors electrode,</b> curved	EK-001-015-20	EK-001-015-25
EK-005-016-20	EK-005-016-25		<b>Scherelektrode, TC,</b> gebogen <b>Scissors electrode, TC,</b> curved	EK-001-016-20	EK-001-016-25









**Bestell-Nr.**  
**Ordering no.**

**EK-010-008** Adapter für 2-Pin Stecker  
Adapter for 2-pin plug



**EK-010-009** Adapter für Flachstecker-Bipolarkabel  
Adapter for flat plug bipolar cable



Einsatz allein Insert only			Instrument komplett Instrument complete		
					
200mm	250mm	Maul Tip	Bezeichnung Description	200mm	250mm
EK-005-010-20	EK-005-010-25		<b>Tubenfasszangenelektrode,</b> gewellter Steg <b>Tubal grasping forceps</b> <b>electrode,</b> rippled bar	EK-002-010-20	EK-002-010-25
EK-005-011-20	EK-005-011-25		<b>Pinzettenelektrode,</b> 1 mm Spitze <b>Fluted bit electrode,</b> 1 mm tip	EK-002-011-20	EK-002-011-25
EK-005-012-20	EK-005-012-25		<b>Kleppingerelektrode,</b> gerieft <b>Kleppinger electrode,</b> serrated	EK-002-012-20	EK-002-012-25
EK-005-013-20	EK-005-013-25		<b>Plattenelektrode,</b> 3mm <b>Plate electrode,</b> 3mm	EK-002-013-20	EK-002-013-25
EK-005-014-20	EK-005-014-25		<b>Maryland</b> Dissektionelektrode, gebogen <b>Maryland</b> dissecting electrode, curved	EK-002-014-20	EK-002-014-25
EK-005-015-20	EK-005-015-25		<b>Scherenelektrode,</b> gebogen <b>Scissors electrode,</b> curved	EK-002-015-20	EK-002-015-25
EK-005-016-20	EK-005-016-25		<b>Scherenelektrode, TC,</b> gebogen <b>Scissors electrode, TC,</b> curved	EK-002-016-20	EK-002-016-25

**Bestell-Nr.**  
**Ordering no.**

**EK-010-008**

Adapter für 2-Pin Stecker  
Adapter for 2-pin plug



**EK-010-009**

Adapter für Flachstecker-Bipolarkabel  
Adapter for flat plug bipolar cable



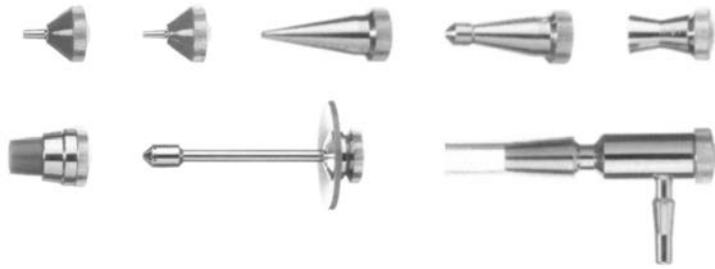

**Bestell-Nr.**  
**Ordering no.**

**EJ-030-010** Reinigungspistole komplett inklusive 9 verschiedenen Aufsätzen  
*Cleaning pistol complete inclusive 9 different tips*



**Bestell-Nr.**  
**Ordering no.**

**EJ-030-001** Ø 3mm Reinigungsbürste, Länge 420mm, Packung mit 10 Stück  
*Ø 3mm cleaning brush, length 420mm, package of 10 pieces*

**EJ-030-002** Ø 5mm Reinigungsbürste, Länge 420mm, Packung mit 10 Stück  
*Ø 5mm cleaning brush, length 420mm, package of 10 pieces*

**EJ-030-003** Ø 10mm Reinigungsbürste, Länge 420mm, Packung mit 10 Stück  
*Ø 10mm cleaning brush, length 420mm, package of 10 pieces*



**Bestell-Nr.**  
**Ordering no.**

**EJ-030-031** Spezialfett für Hähne, Ventile und Instrumente, Tube mit 8 Gramm  
*Special grease for stopcocks, valves and instruments, tube with 8 grams*



**Bestell-Nr.**  
**Ordering no.**

**FA-020-020**

Lagerungsrack für Laparoskopieinstrumente  
*Storage rack for laparoscopic instruments*

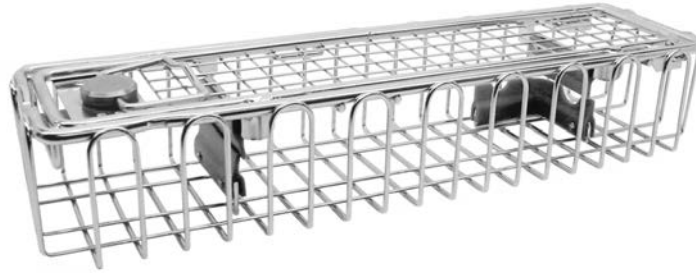

**Bestell-Nr.**  
**Ordering no.**

<b>FA-010-001</b>	Siebkorb für 1 Endoskop mit Deckel, Abmessungen <b>290</b> x 80 x 52mm (L x B x H) <i>Wire basket for 1 endoscope with lid, dimensions <b>290</b> x 80 x 52mm (l x w x h)</i>
<b>FA-010-002</b>	Siebkorb für 1 Endoskop mit Deckel, Abmessungen <b>460</b> x 80 x 52mm (L x B x H) <i>Wire basket for 1 endoscope with lid, dimensions <b>460</b> x 80 x 52mm (l x w x h)</i>
<b>FA-010-003</b>	Siebkorb für 1 Endoskop, Abmessungen <b>670</b> x 80 x 52mm (L x B x H) <i>Wire basket for 1 endoscope with lid, dimensions <b>670</b> x 80 x 52mm (l x w x h)</i>
<b>FA-010-004</b>	Siebkorb für 2 Endoskope mit Deckel, Abmessungen <b>290</b> x 80 x 52mm (L x B x H) <i>Wire basket for 2 endoscopes with lid, dimensions <b>290</b> x 80 x 52mm (l x w x h)</i>
<b>FA-010-005</b>	Siebkorb für 2 Endoskope mit Deckel, Abmessungen <b>460</b> x 80 x 52mm (L x B x H) <i>Wire basket for 2 endoscopes with lid, dimensions <b>460</b> x 80 x 52mm (l x w x h)</i>
<b>FA-010-006</b>	Siebkorb für 1 Endoskop und 1 Kaltlichtkabel mit Deckel, Abmessungen <b>670</b> x 80 x 52mm (L x B x H) <i>Wire basket for 1 endoscope and 1 cold light cable with lid, dimensions <b>670</b> x 80 x 52mm (l x w x h)</i>



**Bestell-Nr.**  
**Ordering no.**

<b>FA-001-001</b>	Endoskop-Container, Deckel <b>silber</b> , Deckel/Boden gelocht (ohne Filter), Abmessungen 450 x 70 x 70mm (L x B x H) <i>Endoscope container, lid <b>silver</b>, lid/bottom perforated (without filter), dimensions 450 x 70 x 70mm (l x w x h)</i>
<b>FA-001-001-G</b>	Endoskop-Container, Deckel <b>grün</b> , Deckel/Boden gelocht (ohne Filter), Abmessungen 450 x 70 x 70mm (L x B x H) <i>Endoscope container, lid <b>green</b>, lid/bottom perforated (without filter), dimensions 450 x 70 x 70mm (l x w x h)</i>
<b>FA-001-001-R</b>	Endoskop-Container, Deckel <b>rot</b> , Deckel/Boden gelocht (ohne Filter), Abmessungen 450 x 70 x 70mm (L x B x H) <i>Endoscope container, lid <b>red</b>, lid/bottom perforated (without filter), dimensions 450 x 70 x 70mm (l x w x h)</i>
<b>FA-002-001</b>	Endoskop-Container, Deckel <b>silber</b> , Deckel/Boden gelocht (ohne Filter), Abmessungen 250 x 60 x 50mm (L x B x H) <i>Endoscope container, lid <b>silver</b>, lid/bottom perforated (without filter), dimensions 250 x 60 x 50mm (l x w x h)</i>
<b>FA-002-001-G</b>	Endoskop-Container, Deckel <b>grün</b> , Deckel/Boden gelocht (ohne Filter), Abmessungen 250 x 60 x 50mm (L x B x H) <i>Endoscope container, lid <b>green</b>, lid/bottom perforated (without filter), dimensions 250 x 60 x 50mm (l x w x h)</i>
<b>FA-002-001-R</b>	Endoskop-Container, Deckel <b>rot</b> , Deckel/Boden gelocht (ohne Filter), Abmessungen 250 x 60 x 50mm (L x B x H) <i>Endoscope container, lid <b>red</b>, lid/bottom perforated (without filter), dimensions 250 x 60 x 50mm (l x w x h)</i>

Bestell-Nr. Ordering no.	Seite Page	Bestell-Nr. Ordering no.	Seite Page	Bestell-Nr. Ordering no.	Seite Page	Bestell-Nr. Ordering no.	Seite Page
EA-000-001	101	EC-003-033-20	123	EC-005-054	59	EC-005-194	63
EA-000-002	101	EC-003-041	123	EC-005-061	59	EC-005-201	63
EA-000-001	103	EC-003-041-20	123	EC-005-061-25	114	EC-005-201-25	118
EA-000-002	103	EC-003-043	123	EC-005-062	59	EC-005-202	63
EA-001-001	8	EC-003-043-20	123	EC-005-063	59	EC-005-203	63
EA-001-001	103	EC-003-111	125	EC-005-063-25	114	EC-005-203-25	118
EA-001-002	8	EC-003-111-20	125	EC-005-064	59	EC-005-204	63
EA-001-002	103	EC-003-113	125	EC-005-111	60	EC-005-211	60
EA-001-011	9	EC-003-113-20	125	EC-005-111-25	115	EC-005-211-25	115
EA-001-012	9	EC-003-121	125	EC-005-112	60	EC-005-212	60
EA-002-001	8	EC-003-121-20	125	EC-005-113	60	EC-005-213	60
EA-002-002	8	EC-003-123	125	EC-005-113-25	115	EC-005-213-25	115
EA-002-003	8	EC-003-123-20	125	EC-005-114	60	EC-005-214	60
EA-002-004	8	EC-003-151	125	EC-005-121	61	EC-005-221	63
EA-002-005	8	EC-003-151-20	125	EC-005-121-25	116	EC-005-221-25	118
EA-002-011	9	EC-003-153	125	EC-005-122	61	EC-005-222	63
EA-002-012	9	EC-003-153-20	125	EC-005-123	61	EC-005-223	63
EA-002-013	9	EC-003-181	125	EC-005-123-25	116	EC-005-223-25	118
EA-002-014	9	EC-003-181-20	125	EC-005-124	61	EC-005-224	63
EA-002-015	9	EC-003-183	125	EC-005-131	61	EC-005-231	62
EA-003-001	8	EC-003-183-20	125	EC-005-131-25	116	EC-005-231-25	117
EA-003-002	8	EC-003-191	125	EC-005-132	61	EC-005-232	62
EA-003-003	8	EC-003-191-20	125	EC-005-133	61	EC-005-233	62
EA-003-004	8	EC-003-193	125	EC-005-133-25	116	EC-005-233-25	117
EA-003-005	8	EC-003-193-20	125	EC-005-134	61	EC-005-234	62
EA-003-006	8	EC-005-001	59	EC-005-141	61	EC-005-241	62
EA-003-007	8	EC-005-001-25	114	EC-005-141-25	116	EC-005-241-25	117
EA-003-008	8	EC-005-002	59	EC-005-142	61	EC-005-242	62
EA-003-011	9	EC-005-003	59	EC-005-143	61	EC-005-243	62
EA-003-012	9	EC-005-003-25	114	EC-005-143-25	116	EC-005-243-25	117
EA-003-015	9	EC-005-004	59	EC-005-144	61	EC-005-244	62
EA-003-016	9	EC-005-011	59	EC-005-151	60	EC-005-251	63
EA-004-001	10	EC-005-011-25	114	EC-005-151-25	115	EC-005-251-25	118
EA-004-002	10	EC-005-012	59	EC-005-152	60	EC-005-252	63
EA-004-003	10	EC-005-013	59	EC-005-153	60	EC-005-253	63
EA-004-004	10	EC-005-013-25	114	EC-005-153-25	115	EC-005-253-25	118
EA-005-001	8	EC-005-014	59	EC-005-154	60	EC-005-254	63
EA-005-002	8	EC-005-021	59	EC-005-161	60	EC-005-261	63
EA-005-011	9	EC-005-021-25	114	EC-005-161-25	115	EC-005-261-25	118
EA-005-012	9	EC-005-022	59	EC-005-162	60	EC-005-262	63
EC-001-001	56	EC-005-023	59	EC-005-163	60	EC-005-263	63
EC-001-001	111	EC-005-023-25	114	EC-005-163-25	115	EC-005-263-25	118
EC-001-002	57	EC-005-024	59	EC-005-164	60	EC-005-264	63
EC-001-002	112	EC-005-031	59	EC-005-171	60	EC-005-271	61
EC-001-003	55	EC-005-031-25	114	EC-005-171-25	115	EC-005-271-25	116
EC-001-003-25	110	EC-005-032	59	EC-005-172	60	EC-005-272	61
EC-001-004	55	EC-005-033	59	EC-005-173	60	EC-005-273	61
EC-001-005	55	EC-005-033-25	114	EC-005-173-25	115	EC-005-273-25	116
EC-001-006	55	EC-005-034	59	EC-005-174	60	EC-005-274	61
EC-002-023	109	EC-005-041	59	EC-005-181	61	EC-005-291	78
EC-002-253	109	EC-005-041-25	114	EC-005-181-25	116	EC-005-291	78
EC-003-001	123	EC-005-042	59	EC-005-182	61	EC-005-292	78
EC-003-001-20	123	EC-005-043	59	EC-005-183	61	EC-005-292	78
EC-003-003	123	EC-005-043-25	114	EC-005-183-25	116	EC-005-293	78
EC-003-003-20	123	EC-005-044	59	EC-005-184	61	EC-005-293	78
EC-003-031	123	EC-005-051	59	EC-005-191	63	EC-005-294	78
EC-003-031-20	123	EC-005-051-25	114	EC-005-191-25	118	EC-005-294	78
EC-003-033	123	EC-005-052	59	EC-005-192	63	EC-005-301	62
		EC-005-053	59	EC-005-193	63	EC-005-301-25	117
		EC-005-053-25	114	EC-005-193-25	118	EC-005-302	62

<b>Bestell-Nr.</b> <b>Ordering no.</b>	<b>Seite</b> <b>Page</b>	<b>Bestell-Nr.</b> <b>Ordering no.</b>	<b>Seite</b> <b>Page</b>	<b>Bestell-Nr.</b> <b>Ordering no.</b>	<b>Seite</b> <b>Page</b>	<b>Bestell-Nr.</b> <b>Ordering no.</b>	<b>Seite</b> <b>Page</b>
EC-005-303	62	EC-005-413	61	ED-001-007	113	ED-005-054	64
EC-005-303-25	117	EC-005-413-25	116	ED-001-008	56	ED-005-061	65
EC-005-304	62	EC-005-414	61	ED-001-008	111	ED-005-061-25	120
EC-005-311	59	EC-005-421	60	ED-001-009	58	ED-005-062	65
EC-005-311-25	114	EC-005-421-25	115	ED-001-009	113	ED-005-063	65
EC-005-312	59	EC-005-422	60	ED-002-203	109	ED-005-063-25	120
EC-005-313	59	EC-005-423	60	ED-002-263	109	ED-005-064	65
EC-005-313-25	114	EC-005-423-25	115	ED-003-011	124	ED-005-071	66
EC-005-314	59	EC-005-424	60	ED-003-011-20	124	ED-005-071-25	121
EC-005-321	62	EC-005-431	61	ED-003-013	124	ED-005-072	66
EC-005-321-25	117	EC-005-431-25	116	ED-003-013-20	124	ED-005-073	66
EC-005-322	62	EC-005-432	61	ED-003-021	124	ED-005-073-25	121
EC-005-323	62	EC-005-433	61	ED-003-021-20	124	ED-005-074	66
EC-005-323-25	117	EC-005-433-25	116	ED-003-023	124	ED-005-081	64
EC-005-324	62	EC-005-434	61	ED-003-023-20	124	ED-005-081-25	119
EC-005-331	62	EC-010-011	68	ED-003-031	124	ED-005-082	64
EC-005-331-25	117	EC-010-012	68	ED-003-031-20	124	ED-005-083	64
EC-005-332	62	EC-010-013	68	ED-003-033	124	ED-005-083-25	119
EC-005-333	62	EC-010-014	68	ED-003-033-20	124	ED-005-084	64
EC-005-333-25	117	EC-010-021	68	ED-003-051	124	ED-005-091	67
EC-005-334	62	EC-010-022	68	ED-003-051-20	124	ED-005-091-25	122
EC-005-341	62	EC-010-023	68	ED-003-053	124	ED-005-092	67
EC-005-341-25	117	EC-010-024	68	ED-003-053-20	124	ED-005-093	67
EC-005-342	62	EC-010-121	69	ED-003-071	124	ED-005-093-25	122
EC-005-343	62	EC-010-122	69	ED-003-071-20	124	ED-005-094	67
EC-005-343-25	117	EC-010-123	69	ED-003-073	124	ED-005-101	64
EC-005-344	62	EC-010-124	69	ED-003-073-20	124	ED-005-101-25	119
EC-005-351	59	EC-010-141	69	ED-003-201	124	ED-005-102	64
EC-005-351-25	114	EC-010-142	69	ED-003-201-20	124	ED-005-103	64
EC-005-352	59	EC-010-143	69	ED-003-203	124	ED-005-103-25	119
EC-005-353	59	EC-010-144	69	ED-003-203-20	124	ED-005-104	64
EC-005-353-25	114	EC-010-171	69	ED-005-011	64	ED-005-111	67
EC-005-354	59	EC-010-172	69	ED-005-011-25	119	ED-005-111-25	122
EC-005-361	60	EC-010-173	69	ED-005-012	64	ED-005-112	67
EC-005-361-25	115	EC-010-174	69	ED-005-013	64	ED-005-113	67
EC-005-362	60	EC-010-191	69	ED-005-013-25	119	ED-005-113-25	122
EC-005-363	60	EC-010-192	69	ED-005-014	64	ED-005-114	67
EC-005-363-25	115	EC-010-193	69	ED-005-021	64	ED-005-151	67
EC-005-364	60	EC-010-194	69	ED-005-021-25	119	ED-005-151-25	122
EC-005-371	59	EC-010-201	69	ED-005-022	64	ED-005-152	67
EC-005-371-25	114	EC-010-202	69	ED-005-023	64	ED-005-153	67
EC-005-372	59	EC-010-203	69	ED-005-023-25	119	ED-005-153-25	122
EC-005-373	59	EC-010-204	69	ED-005-024	64	ED-005-154	67
EC-005-373-25	114	EC-010-211	69	ED-005-031	65	ED-005-161	66
EC-005-374	59	EC-010-212	69	ED-005-031-25	120	ED-005-161-25	121
EC-005-391	60	EC-010-213	69	ED-005-032	65	ED-005-162	66
EC-005-391-25	115	EC-010-214	69	ED-005-033	65	ED-005-163	66
EC-005-392	60	ED-001-002	57	ED-005-033-25	120	ED-005-163-25	121
EC-005-393	60	ED-001-002	112	ED-005-034	65	ED-005-164	66
EC-005-393-25	115	ED-001-003	57	ED-005-041	64	ED-005-171	65
EC-005-394	60	ED-001-003	112	ED-005-041-25	119	ED-005-171-25	120
EC-005-401	63	ED-001-004	58	ED-005-042	64	ED-005-172	65
EC-005-401-25	118	ED-001-004	113	ED-005-043	64	ED-005-173	65
EC-005-402	63	ED-001-005	57	ED-005-043-25	119	ED-005-173-25	120
EC-005-403	63	ED-001-005	112	ED-005-044	64	ED-005-174	65
EC-005-403-25	118	ED-001-006	58	ED-005-051	64	ED-005-181	65
EC-005-404	63	ED-001-006	113	ED-005-051-25	119	ED-005-181-25	120
EC-005-411	61	ED-001-007	58	ED-005-052	64	ED-005-182	65
EC-005-411-25	116			ED-005-053	64	ED-005-183	65
EC-005-412	61			ED-005-053-25	119	ED-005-183-25	120



<b>Bestell-Nr.</b> <b>Ordering no.</b>	<b>Seite</b> <b>Page</b>	<b>Bestell-Nr.</b> <b>Ordering no.</b>	<b>Seite</b> <b>Page</b>	<b>Bestell-Nr.</b> <b>Ordering no.</b>	<b>Seite</b> <b>Page</b>	<b>Bestell-Nr.</b> <b>Ordering no.</b>	<b>Seite</b> <b>Page</b>
ED-005-184	65	ED-005-354	66	ED-010-052	70	ED-010-332	71
ED-005-191	64	ED-005-361	64	ED-010-053	70	ED-010-333	71
ED-005-191-25	119	ED-005-361-25	119	ED-010-053-A	72	ED-010-334	71
ED-005-192	64	ED-005-362	64	ED-010-054	70	ED-010-341	70
ED-005-193	64	ED-005-363	64	ED-010-081	70	ED-010-342	70
ED-005-193-25	119	ED-005-363-25	119	ED-010-082	70	ED-010-343	70
ED-005-194	64	ED-005-364	64	ED-010-083	70	ED-010-344	70
ED-005-201	65	ED-005-371	64	ED-010-083-A	72	ED-010-351	71
ED-005-201-25	120	ED-005-371-25	119	ED-010-084	70	ED-010-352	71
ED-005-202	65	ED-005-372	64	ED-010-101	70	ED-010-353	71
ED-005-203	65	ED-005-373	64	ED-010-102	70	ED-010-354	71
ED-005-203-25	120	ED-005-373-25	119	ED-010-103	70	ED-020-001	87
ED-005-204	65	ED-005-374	64	ED-010-103-A	72	ED-030-001	73
ED-005-211	66	ED-005-381	65	ED-010-104	70	ED-030-002	73
ED-005-211-25	121	ED-005-381-25	120	ED-010-161	71	ED-030-003	73
ED-005-212	66	ED-005-382	65	ED-010-162	71	ED-030-004	73
ED-005-213	66	ED-005-383	65	ED-010-163	71	ED-030-005	73
ED-005-213-25	121	ED-005-383-25	120	ED-010-164	71	ED-030-006	73
ED-005-214	66	ED-005-384	65	ED-010-221	71	ED-030-007	73
ED-005-261	67	ED-005-391	66	ED-010-222	71	ED-030-008	73
ED-005-261-25	122	ED-005-391-25	121	ED-010-223	71	ED-030-009	73
ED-005-262	67	ED-005-392	66	ED-010-224	71	ED-030-010	73
ED-005-263	67	ED-005-393	66	ED-010-231	70	ED-030-011	73
ED-005-263-25	122	ED-005-393-25	121	ED-010-232	70	EE-000-001	107
ED-005-264	67	ED-005-394	66	ED-010-233	70	EE-000-001-20	107
ED-005-281	66	ED-005-401	67	ED-010-234	70	EE-000-001-25	107
ED-005-281-25	121	ED-005-401-25	122	ED-010-241	70	EE-000-002	107
ED-005-282	66	ED-005-402	67	ED-010-242	70	EE-000-002-20	107
ED-005-283	66	ED-005-403	67	ED-010-243	70	EE-000-002-25	107
ED-005-283-25	121	ED-005-403-25	122	ED-010-244	70	EE-000-003	107
ED-005-284	66	ED-005-404	67	ED-010-251	70	EE-000-003-20	107
ED-005-311	65	ED-005-411	67	ED-010-252	70	EE-000-003-25	107
ED-005-311-25	120	ED-005-411-25	122	ED-010-253	70	EE-000-005	107
ED-005-312	65	ED-005-412	67	ED-010-254	70	EE-000-005-20	107
ED-005-313	65	ED-005-413	67	ED-010-261	71	EE-000-005-25	107
ED-005-313-25	120	ED-005-413-25	122	ED-010-262	71	EE-000-006	107
ED-005-314	65	ED-005-414	67	ED-010-263	71	EE-000-006-20	107
ED-005-321	65	ED-005-421	66	ED-010-263-A	72	EE-000-006-25	107
ED-005-321-25	120	ED-005-421-25	121	ED-010-264	71	EE-001-001	51
ED-005-322	65	ED-005-422	66	ED-010-281	71	EE-001-002	51
ED-005-323	65	ED-005-423	66	ED-010-282	71	EE-001-003	51
ED-005-323-25	120	ED-005-423-25	121	ED-010-283	71	EE-001-005	51
ED-005-324	65	ED-005-424	66	ED-010-284	71	EE-001-006	51
ED-005-331	64	ED-005-431	65	ED-010-291	71	EE-001-011	51
ED-005-331-25	119	ED-005-431-25	120	ED-010-292	71	EE-001-012	51
ED-005-332	64	ED-005-432	65	ED-010-293	71	EE-001-013	51
ED-005-333	64	ED-005-433	65	ED-010-294	71	EE-001-015	51
ED-005-333-25	119	ED-005-433-25	120	ED-010-301	70	EE-001-016	51
ED-005-334	64	ED-005-434	65	ED-010-302	70	EE-001-021	51
ED-005-341	66	ED-005-451	67	ED-010-303	70	EE-001-022	51
ED-005-341-25	121	ED-005-451-25	122	ED-010-304	70	EE-001-023	51
ED-005-342	66	ED-005-452	67	ED-010-311	70	EE-001-025	51
ED-005-343	66	ED-005-453	67	ED-010-312	70	EE-001-026	51
ED-005-343-25	121	ED-005-453-25	122	ED-010-313	70	EE-001-031	51
ED-005-344	66	ED-005-454	67	ED-010-314	70	EE-001-032	51
ED-005-351	66	ED-010-011	71	ED-010-321	70	EE-001-033	51
ED-005-351-25	121	ED-010-012	71	ED-010-322	70	EE-001-035	51
ED-005-352	66	ED-010-013	71	ED-010-323	70	EE-001-036	51
ED-005-353	66	ED-010-014	71	ED-010-324	70	EE-001-041	52
ED-005-353-25	121	ED-010-051	70	ED-010-331	71	EE-001-042	52

<b>Bestell-Nr.</b> <b>Ordering no.</b>	<b>Seite</b> <b>Page</b>	<b>Bestell-Nr.</b> <b>Ordering no.</b>	<b>Seite</b> <b>Page</b>	<b>Bestell-Nr.</b> <b>Ordering no.</b>	<b>Seite</b> <b>Page</b>	<b>Bestell-Nr.</b> <b>Ordering no.</b>	<b>Seite</b> <b>Page</b>
EE-001-043	52	EG-002-002	82	EG-003-032	108	EH-005-201	14
EE-001-045	52	EG-002-002	83	EG-003-034	108	EH-005-201	104
EE-001-046	52	EG-002-003	82	EG-003-041	77	EH-005-202	14
EE-001-051	52	EG-002-004	82	EG-003-042	75	EH-005-203	14
EE-001-052	52	EG-002-005	82	EG-003-043	75	EH-005-206	14
EE-001-053	52	EG-002-006	82	EG-003-044	75	EH-005-207	14
EE-001-055	52	EG-002-007	82	EG-003-045	75	EH-005-208	14
EE-001-056	52	EG-002-008	82	EG-003-045-1	75	EH-005-209	14
EE-002-000	53	EG-002-010	82	EG-003-049	75	EH-005-210	14
EE-002-001	53	EG-002-011	82	EG-003-050	75	EH-005-218	28
EE-002-002	53	EG-002-012	82	EG-003-051	75	EH-005-219	28
EE-002-003	53	EG-002-013	82	EG-003-052	75	EH-005-220	28
EE-002-004	53	EG-002-014	82	EG-003-053	75	EH-006-103	14
EE-002-005	53	EG-002-015	82	EG-003-054	75	EH-006-109	14
EE-002-006	53	EG-002-021	81	EG-003-055	75	EH-006-110	14
EE-002-010	53	EG-002-022	81	EG-003-056	75	EH-006-203	14
EE-002-011	53	EG-002-023	81	EG-003-057	75	EH-006-209	14
EE-004-000	49	EG-002-024	81	EG-003-058	75	EH-006-210	14
EE-004-001	49	EG-002-025	81	EG-003-059	75	EH-007-003	17
EE-004-001	50	EG-002-026	81	EG-003-066	76	EH-007-009	17
EE-004-002	49	EG-002-028	81	EG-003-067	76	EH-007-010	17
EE-004-002	50	EG-002-029	81	EG-003-068	76	EH-007-103	17
EE-004-003	49	EG-002-030	80	EG-003-069	76	EH-007-109	17
EE-004-003	50	EG-002-031	80	EG-003-070	76	EH-007-110	17
EE-004-005	49	EG-002-032	80	EG-003-071	76	EH-007-203	17
EE-004-005	50	EG-002-035	80	EG-003-072	76	EH-007-209	17
EE-004-006	49	EG-002-036	80	EG-003-101	77	EH-007-210	17
EE-004-006	50	EG-002-040	80	EG-003-102	77	EH-008-003	17
EE-004-021	50	EG-002-041	80	EG-003-103	77	EH-008-009	17
EE-004-022	50	EG-002-042	80	EG-003-104	77	EH-008-010	17
EE-004-024	50	EG-002-043	80	EG-004-001	79	EH-008-103	17
EE-005-001	54	EG-002-046	80	EG-004-002	79	EH-008-109	17
EE-005-002	54	EG-002-050	83	EG-034-001	38	EH-008-110	17
EE-005-003	54	EG-002-051	83	EG-034-002	38	EH-008-203	17
EE-005-005	54	EG-002-052	83	EG-034-003	38	EH-008-209	17
EE-005-006	54	EG-002-053	83	EG-034-004	38	EH-008-210	17
EE-005-021	54	EG-002-055	83	EG-034-005	38	EH-009-012	26
EE-005-022	54	EG-002-056	83	EG-034-006	38	EH-009-013	26
EE-005-023	54	EG-002-057	83	EH-000-001	104	EH-009-018	28
EE-005-025	54	EG-002-058	83	EH-000-101	104	EH-009-019	28
EE-005-026	54	EG-003-001	74	EH-000-201	104	EH-009-020	28
EE-010-001	96	EG-003-001-45	74	EH-001-001	104	EH-009-101	13
EE-010-001	96	EG-003-002	74	EH-001-101	104	EH-009-102	13
EE-010-002	96	EG-003-002-45	74	EH-001-201	104	EH-009-103	13
EE-010-003	96	EG-003-003	74	EH-005-001	104	EH-009-106	13
EE-010-003	96	EG-003-003-45	74	EH-005-018	28	EH-009-107	13
EE-010-004	96	EG-003-004	74	EH-005-019	28	EH-009-108	13
EE-010-004	96	EG-003-004-45	74	EH-005-020	28	EH-009-109	13
EE-010-011	96	EG-003-011	108	EH-005-101	14	EH-009-110	13
EE-010-012	96	EG-003-012	108	EH-005-101	104	EH-009-111	13
EE-010-013	96	EG-003-013	108	EH-005-102	14	EH-009-112	26
EE-010-014	96	EG-003-021	74	EH-005-103	14	EH-009-113	26
EE-010-014	96	EG-003-021-45	74	EH-005-106	14	EH-009-118	28
EG-001-001	79	EG-003-022	74	EH-005-107	14	EH-009-119	28
EG-001-002	79	EG-003-022-45	74	EH-005-108	14	EH-009-120	28
EG-001-003	79	EG-003-023	74	EH-005-109	14	EH-009-201	13
EG-001-011	79	EG-003-023-45	74	EH-005-110	14	EH-009-202	13
EG-001-013	79	EG-003-024	74	EH-005-118	28	EH-009-203	13
EG-002-001	82	EG-003-024-45	74	EH-005-119	28	EH-009-206	13
EG-002-001	83	EG-003-031	108	EH-005-120	28	EH-009-207	13

<b>Bestell-Nr.</b> <b>Ordering no.</b>	<b>Seite</b> <b>Page</b>	<b>Bestell-Nr.</b> <b>Ordering no.</b>	<b>Seite</b> <b>Page</b>	<b>Bestell-Nr.</b> <b>Ordering no.</b>	<b>Seite</b> <b>Page</b>	<b>Bestell-Nr.</b> <b>Ordering no.</b>	<b>Seite</b> <b>Page</b>
EH-009-208	13	EH-016-009	21	EH-029-009	16	EH-033-002	11
EH-009-209	13	EH-016-010	21	EH-029-010	16	EH-033-003	11
EH-009-210	13	EH-016-103	21	EH-029-103	16	EH-033-004	11
EH-009-211	13	EH-016-109	21	EH-029-109	16	EH-033-005	11
EH-009-212	26	EH-016-110	21	EH-029-111	16	EH-033-006	11
EH-009-213	26	EH-016-203	21	EH-029-203	16	EH-033-007	11
EH-009-218	28	EH-016-209	21	EH-029-209	16	EH-033-008	11
EH-009-219	28	EH-016-210	21	EH-029-210	16	EH-033-009	11
EH-009-220	28	EH-017-003	21	EH-029-303	16	EH-033-010	11
EH-010-001	104	EH-017-009	21	EH-029-309	16	EH-033-011	11
EH-010-101	104	EH-017-010	21	EH-029-310	16	EH-033-012	11
EH-010-201	104	EH-017-103	21	EH-029-403	16	EH-033-024	11
EH-011-001	12	EH-017-109	21	EH-029-409	16	EH-033-025	11
EH-011-003	12	EH-017-110	21	EH-029-410	16	EH-033-028	11
EH-011-009	12	EH-017-203	21	EH-029-503	16	EH-033-029	11
EH-011-010	12	EH-017-209	21	EH-029-509	16	EH-035-001	41
EH-011-301	12	EH-017-210	21	EH-029-510	16	EH-035-002	41
EH-011-303	12	EH-022-002	37	EH-030-002	34	EH-035-003	41
EH-011-309	12	EH-022-003	37	EH-030-003	34	EH-035-004	41
EH-011-310	12	EH-022-007	37	EH-030-008	34	EH-035-005	41
EH-014-001	19	EH-022-008	37	EH-030-009	34	EH-035-007	43
EH-014-003	19	EH-022-009	37	EH-030-010	34	EH-035-008	43
EH-014-006	19	EH-022-010	37	EH-032-001	39	EH-035-009	47
EH-014-007	19	EH-022-011	37	EH-032-002	39	EH-035-009	49
EH-014-008	19	EH-022-018	37	EH-032-003	39	EH-035-011	42
EH-014-009	19	EH-022-019	37	EH-032-004	39	EH-035-012	42
EH-014-010	19	EH-022-020	37	EH-032-005	39	EH-035-013	42
EH-014-018	29	EH-022-021	37	EH-032-006	39	EH-035-014	44
EH-014-019	29	EH-022-033	38	EH-032-007	39	EH-035-016	106
EH-014-020	29	EH-022-034	38	EH-032-008	39	EH-035-017	43
EH-014-101	19	EH-022-035	38	EH-032-009	39	EH-035-018	43
EH-014-103	19	EH-022-036	38	EH-032-010	40	EH-035-019	47
EH-014-106	19	EH-023-002	37	EH-032-011	39	EH-035-019	49
EH-014-107	19	EH-023-003	37	EH-032-020	39	EH-035-021	42
EH-014-108	19	EH-023-007	37	EH-032-021	39	EH-035-022	42
EH-014-109	19	EH-023-008	37	EH-032-022	39	EH-035-023	42
EH-014-110	19	EH-023-009	37	EH-032-023	39	EH-035-024	42
EH-014-118	29	EH-023-010	37	EH-032-024	39	EH-035-025	42
EH-014-119	29	EH-023-011	37	EH-032-025	39	EH-035-026	42
EH-014-120	29	EH-024-002	37	EH-032-026	39	EH-035-027	42
EH-014-201	19	EH-024-003	37	EH-032-027	39	EH-035-028	42
EH-014-203	19	EH-024-007	37	EH-032-028	39	EH-035-029	43
EH-014-206	19	EH-024-008	37	EH-032-029	39	EH-035-030	43
EH-014-207	19	EH-024-009	37	EH-032-030	39	EH-035-031	47
EH-014-208	19	EH-024-010	37	EH-032-031	39	EH-035-032	47
EH-014-209	19	EH-024-020	37	EH-032-032	39	EH-035-033	47
EH-014-210	19	EH-024-021	37	EH-032-033	39	EH-035-034	44
EH-014-218	29	EH-024-022	37	EH-032-034	39	EH-035-035	44
EH-014-219	29	EH-024-023	37	EH-032-035	39	EH-035-036	42
EH-014-220	29	EH-024-024	37	EH-032-036	39	EH-035-037	42
EH-015-003	19	EH-024-025	37	EH-032-037	39	EH-035-037	44
EH-015-009	19	EH-025-001	38	EH-032-038	39	EH-035-038	44
EH-015-010	19	EH-025-001	105	EH-032-039	39	EH-035-039	44
EH-015-103	19	EH-028-103	13	EH-032-041	39	EH-035-041	42
EH-015-109	19	EH-028-109	13	EH-032-042	39	EH-035-042	42
EH-015-110	19	EH-028-110	13	EH-032-045	39	EH-035-043	42
EH-015-203	19	EH-028-203	13	EH-032-046	39	EH-035-044	42
EH-015-209	19	EH-028-209	13	EH-032-047	39	EH-035-045	44
EH-015-210	19	EH-028-210	13	EH-032-048	39	EH-035-060	48
EH-016-003	21	EH-029-003	16	EH-033-001	11	EH-035-061	48

<b>Bestell-Nr.</b> <b>Ordering no.</b>	<b>Seite</b> <b>Page</b>	<b>Bestell-Nr.</b> <b>Ordering no.</b>	<b>Seite</b> <b>Page</b>	<b>Bestell-Nr.</b> <b>Ordering no.</b>	<b>Seite</b> <b>Page</b>	<b>Bestell-Nr.</b> <b>Ordering no.</b>	<b>Seite</b> <b>Page</b>
EH-035-062	48	EH-109-118	31	EH-128-111	15	EJ-001-017	35
EH-036-001	45	EH-109-119	31	EH-128-203	15	EJ-001-018	35
EH-036-003	45	EH-109-120	31	EH-128-209	15	EJ-001-019	35
EH-036-011	46	EH-109-201	15	EH-128-211	15	EJ-001-019-1	35
EH-036-012	46	EH-109-203	15	EH-129-003	18	EJ-001-020	36
EH-036-013	46	EH-109-209	15	EH-129-009	18	EJ-001-021	36
EH-036-021	46	EH-109-211	15	EH-129-011	18	EJ-001-022	36
EH-036-022	46	EH-109-218	31	EH-129-103	18	EJ-001-023	36
EH-036-023	46	EH-109-219	31	EH-129-109	18	EJ-001-024	36
EH-036-024	46	EH-109-220	31	EH-129-111	18	EJ-001-025	36
EH-038-001	106	EH-114-003	20	EH-129-203	18	EJ-001-026	36
EH-038-001-25	106	EH-114-009	20	EH-129-209	18	EJ-001-027	36
EH-038-002	106	EH-114-011	20	EH-129-211	18	EJ-001-028	36
EH-038-002-25	106	EH-114-018	32	EH-129-303	18	EJ-001-029	36
EH-038-003	106	EH-114-019	32	EH-129-309	18	EJ-001-030	36
EH-038-033	43	EH-114-020	32	EH-129-311	18	EJ-002-000	105
EH-038-033	106	EH-114-103	20	EH-129-403	18	EJ-002-001	35
EH-039-001	41	EH-114-109	20	EH-129-409	18	EJ-002-001	105
EH-040-001	40	EH-114-111	20	EH-129-411	18	EJ-002-001-1	35
EH-040-002	40	EH-114-118	32	EH-129-503	18	EJ-002-001-1	105
EH-040-003	40	EH-114-119	32	EH-129-509	18	EJ-002-002	35
EH-040-004	40	EH-114-120	32	EH-129-511	18	EJ-002-003	35
EH-040-005	40	EH-114-203	20	EI-001-001	85	EJ-002-006	35
EH-040-006	40	EH-114-209	20	EI-001-002	85	EJ-002-007	35
EH-041-001	40	EH-114-211	20	EI-001-003	85	EJ-002-008	35
EH-041-002	40	EH-114-218	32	EI-001-004	85	EJ-002-009	35
EH-041-003	40	EH-114-219	32	EI-001-011	85	EJ-002-010	35
EH-041-004	40	EH-114-220	32	EI-001-012	85	EJ-002-011	35
EH-041-005	40	EH-115-003	20	EI-001-013	85	EJ-002-012	35
EH-041-006	40	EH-115-009	20	EI-001-014	85	EJ-002-013	35
EH-041-007	40	EH-115-011	20	EI-001-033	86	EJ-002-017	35
EH-041-008	40	EH-115-103	20	EI-001-034	86	EJ-002-018	35
EH-041-009	40	EH-115-109	20	EI-001-035	86	EJ-002-019	35
EH-041-010	40	EH-115-111	20	EI-001-050	87	EJ-002-019-1	35
EH-041-011	40	EH-115-203	20	EI-001-052	87	EJ-002-020	36
EH-041-012	40	EH-115-209	20	EI-001-053	87	EJ-002-021	36
EH-041-025	40	EH-115-211	20	EI-001-054	87	EJ-002-022	36
EH-041-025	106	EH-116-003	22	EI-001-055	87	EJ-002-023	36
EH-041-026	106	EH-116-009	22	EI-001-056	87	EJ-002-024	36
EH-042-001	40	EH-116-011	22	EI-001-057	87	EJ-002-025	36
EH-042-002	40	EH-116-103	22	EI-001-058	87	EJ-002-026	36
EH-042-003	40	EH-116-109	22	EI-002-001	86	EJ-002-027	36
EH-042-004	40	EH-116-111	22	EI-002-002	86	EJ-002-028	36
EH-042-011	40	EH-116-203	22	EI-002-011	86	EJ-002-029	36
EH-042-011	105	EH-116-209	22	EI-002-012	86	EJ-002-030	36
EH-042-012	40	EH-116-211	22	EJ-001-000	105	EJ-011-001	35
EH-042-012	105	EH-117-003	22	EJ-001-001	35	EJ-011-002	35
EH-042-013	40	EH-117-009	22	EJ-001-001	105	EJ-011-003	35
EH-042-013	105	EH-117-011	22	EJ-001-001-1	35	EJ-011-008	35
EH-109-001	15	EH-117-103	22	EJ-001-001-1	105	EJ-011-009	35
EH-109-003	15	EH-117-109	22	EJ-001-002	35	EJ-011-010	35
EH-109-009	15	EH-117-111	22	EJ-001-003	35	EJ-012-001	12
EH-109-011	15	EH-117-203	22	EJ-001-006	35	EJ-012-003	12
EH-109-018	31	EH-117-209	22	EJ-001-007	35	EJ-012-008	12
EH-109-019	31	EH-117-211	22	EJ-001-008	35	EJ-012-009	12
EH-109-020	31	EH-128-003	15	EJ-001-009	35	EJ-012-010	12
EH-109-101	15	EH-128-009	15	EJ-001-010	35	EJ-012-011	12
EH-109-103	15	EH-128-011	15	EJ-001-011	35	EJ-013-010	12
EH-109-109	15	EH-128-103	15	EJ-001-012	35	EJ-015-001	23
EH-109-111	15	EH-128-109	15	EJ-001-013	35	EJ-015-003	23

Bestell-Nr. Ordering no.	Seite Page	Bestell-Nr. Ordering no.	Seite Page	Bestell-Nr. Ordering no.	Seite Page	Bestell-Nr. Ordering no.	Seite Page
EJ-015-017	30	EJ-015-009	23	EK-001-021-25	127	EK-003-042	93
EJ-015-023	23	EJ-015-010	23	EK-001-022	90	EK-003-043	93
EJ-015-029	23	EJ-015-011	23	EK-001-022-25	127	EK-003-044	93
EJ-015-031	23	EJ-015-012	26	EK-001-023	90	EK-003-045	93
EJ-015-033	33	EJ-015-013	26	EK-001-023-25	127	EK-003-052	93
EJ-015-039	33	EJ-015-015	30	EK-001-024	90	EK-003-053	93
EJ-015-041	33	EJ-015-016	30	EK-001-024-25	127	EK-003-054	93
EJ-016-003	23	EJ-022-001	30	EK-001-025	90	EK-003-055	93
EJ-016-009	23	EJ-022-002	25	EK-001-025-25	127	EK-004-001	94
EJ-016-010	23	EJ-022-002	30	EK-001-026	90	EK-004-002	94
EJ-016-023	23	EJ-022-003	25	EK-001-026-25	127	EK-004-003	94
EJ-016-029	23	EJ-022-003	30	EK-002-008	89	EK-004-004	94
EJ-016-031	23	EJ-022-004	27	EK-002-008	126	EK-004-005	94
EJ-017-003	24	EJ-022-006	33	EK-002-010	91	EK-004-011	95
EJ-017-009	24	EJ-022-007	33	EK-002-010-20	128	EK-004-013	95
EJ-017-010	24	EJ-022-008	33	EK-002-011	91	EK-004-017	95
EJ-017-013	24	EJ-023-001	25	EK-002-011-20	128	EK-004-018	95
EJ-017-018	24	EJ-023-001	30	EK-002-012	91	EK-004-019	95
EJ-017-019	24	EJ-023-001	33	EK-002-012-20	128	EK-004-020	95
EJ-017-020	24	EJ-023-002	25	EK-002-013	91	EK-004-021	95
EJ-017-023	24	EJ-023-002	30	EK-002-013-20	128	EK-004-023	95
EJ-017-029	24	EJ-023-002	33	EK-002-014	91	EK-004-051	94
EJ-017-030	24	EJ-030-001	129	EK-002-014-20	128	EK-004-060	95
EJ-017-031	24	EJ-030-002	129	EK-002-015	91	EK-004-061	95
EJ-017-032	24	EJ-030-003	129	EK-002-015-20	128	EK-004-063	95
EJ-020-001	25	EJ-030-010	129	EK-002-016	91	EK-004-067	95
EJ-020-001	30	EJ-030-031	129	EK-002-016-20	128	EK-004-068	95
EJ-020-002	25	EK-000-001	88	EK-002-020	91	EK-004-069	95
EJ-020-002	30	EK-000-002	88	EK-002-020-25	128	EK-005-010	90
EJ-020-004	25	EK-000-003	88	EK-002-021	91	EK-005-010	91
EJ-020-004	30	EK-000-004	88	EK-002-021-25	128	EK-005-010-20	127
EJ-020-005	25	EK-000-005	88	EK-002-022	91	EK-005-010-20	128
EJ-020-005	30	EK-000-006	88	EK-002-022-25	128	EK-005-011	90
EJ-020-006	25	EK-001-003	89	EK-002-023	91	EK-005-011	91
EJ-020-006	25	EK-001-003-20	126	EK-002-023-25	128	EK-005-011-20	127
EJ-020-006	30	EK-001-003-25	126	EK-002-024	91	EK-005-011-20	128
EJ-020-006	33	EK-001-004	89	EK-002-024-25	128	EK-005-012	90
EJ-020-007	25	EK-001-004-20	126	EK-002-025	91	EK-005-012	91
EJ-020-007	30	EK-001-004-25	126	EK-002-025-25	128	EK-005-012-20	127
EJ-020-008	27	EK-001-005	89	EK-002-026	91	EK-005-012-20	128
EJ-020-009	27	EK-001-006	89	EK-002-026-25	128	EK-005-013	90
EJ-020-011	25	EK-001-007	89	EK-003-002	92	EK-005-013	91
EJ-020-011	33	EK-001-007	126	EK-003-002	93	EK-005-013-20	127
EJ-020-012	25	EK-001-010	90	EK-003-003	92	EK-005-013-20	128
EJ-020-012	33	EK-001-010-20	127	EK-003-010	92	EK-005-014	90
EJ-021-001	25	EK-001-011	90	EK-003-011	92	EK-005-014	91
EJ-021-001	30	EK-001-011-20	127	EK-003-012	92	EK-005-014-20	127
EJ-021-002	25	EK-001-012	90	EK-003-013	92	EK-005-014-20	128
EJ-021-002	30	EK-001-012-20	127	EK-003-014	92	EK-005-015	90
EJ-021-003	25	EK-001-013	90	EK-003-015	92	EK-005-015	91
EJ-021-003	30	EK-001-013-20	127	EK-003-016	92	EK-005-015-20	127
EJ-021-004	27	EK-001-014	90	EK-003-020	92	EK-005-015-20	128
EJ-021-005	27	EK-001-014-20	127	EK-003-021	92	EK-005-016	90
EJ-021-006	25	EK-001-015	90	EK-003-022	92	EK-005-016	91
EJ-021-006	33	EK-001-015-20	127	EK-003-023	92	EK-005-016-20	127
EJ-021-007	25	EK-001-016	90	EK-003-024	92	EK-005-016-20	128
EJ-021-007	33	EK-001-016-20	127	EK-003-025	92	EK-005-020	90
EJ-021-008	25	EK-001-020	90	EK-003-026	92	EK-005-020	91
EJ-021-008	33	EK-001-020-25	127	EK-003-039	93	EK-005-020-25	127
EJ-022-001	25	EK-001-021	90	EK-003-040	93	EK-005-020-25	128

<b>Bestell-Nr.</b> <b>Ordering no.</b>	<b>Seite</b> <b>Page</b>	<b>Bestell-Nr.</b> <b>Ordering no.</b>	<b>Seite</b> <b>Page</b>
EK-005-021	90	EK-020-006	88
EK-005-021	91	EL-001-001	34
EK-005-021-25	127	EL-002-003	100
EK-005-021-25	128	EL-002-004	101
EK-005-022	90	EL-002-030	102
EK-005-022	91	EL-002-031	102
EK-005-022-25	127	EL-002-032	102
EK-005-022-25	128	EL-002-033	102
EK-005-023	90	EL-002-034	102
EK-005-023	91	EL-002-035	102
EK-005-023-25	127	EL-010-010	84
EK-005-023-25	128	EL-010-011	84
EK-005-024	90	EL-010-012	84
EK-005-024	91	EL-010-013	84
EK-005-024-25	127	FA-001-001	131
EK-005-024-25	128	FA-001-001-G	131
EK-005-025	90	FA-001-001-R	131
EK-005-025	91	FA-002-001	131
EK-005-025-25	127	FA-002-001-G	131
EK-005-025-25	128	FA-002-001-R	131
EK-005-026	90	FA-010-001	131
EK-005-026	91	FA-010-002	131
EK-005-026-25	127	FA-010-003	131
EK-005-026-25	128	FA-010-004	131
EK-010-008	90	FA-010-005	131
EK-010-008	91	FA-010-006	131
EK-010-008	127	FA-020-020	130
EK-010-008	128		
EK-010-009	90		
EK-010-009	91		
EK-010-009	127		
EK-010-009	128		
EK-010-010	97		
EK-010-011	97		
EK-010-012	97		
EK-010-013	97		
EK-010-014	97		
EK-010-015	97		
EK-010-016	97		
EK-010-017	97		
EK-010-030	98		
EK-010-031	98		
EK-010-032	98		
EK-010-033	98		
EK-010-034	98		
EK-010-035	98		
EK-010-036	98		
EK-010-037	98		
EK-010-060	99		
EK-010-061	99		
EK-010-062	99		
EK-010-063	99		
EK-010-064	99		
EK-010-065	99		
EK-010-066	99		
EK-010-067	99		
EK-020-001	88		
EK-020-002	88		
EK-020-003	88		
EK-020-005	88		











STEMA Medizintechnik GmbH  
H.-E.-Bussestr. 4  
78333 Stockach - Germany

Phone: 0049 (0) 77 71 / 87 53 51  
Fax: 0049 (0) 77 71 / 87 53 50

[info@stema-medizintechnik.de](mailto:info@stema-medizintechnik.de)  
[www.stema-medizintechnik.de](http://www.stema-medizintechnik.de)