

UROLOGIE

UROLOGY



Service/Zertifikate

Die STEMA Medizintechnik GmbH ist nach den höchsten Standards zertifiziert.

- DIN EN ISO 13485:2016 + AC:2016
- EG Richtlinien 93/42/EWG Anhang II ohne Abschnitt 4
- EG Richtlinien 93/42/EWG Anhang V ohne Abschnitt 3
- FDA

Diese Standards bilden eine essentielle Grundlage für unser Unternehmen und unsere Partner.

Sie symbolisieren ebenfalls das Engagement und Erstreben die Qualität unserer Produkte langfristig zu sichern.

Service/Certificates

STEMA Medizintechnik GmbH is certified in accordance with the highest standards.

- DIN EN ISO 13485:2016 + AC:2016
- Council Directive 93/42/EEC Annex II excluding Section 4
- Council Directive 93/42/EEC Annex V excluding Section 3
- FDA

These standards create an essential base for our company and our partners.

They also symbolize the commitment and strive to keep up the quality of our products.

Produkte

Das aktuelle Produktsortiment der STEMA Medizintechnik GmbH umfasst mehr als 10.000 verschiedene Artikel.

Wir decken folgende Segmente für die Chirurgie mit qualitativ hochwertigen Produkten ab:

- **Arthroskopie**
- **Bronchoskopie**
- **Container-Systeme**
- **Gastro-Intestinal**
- **Geräte**
- **Gynäkologie**
- **Herz-MIC**
- **HF-Chirurgie**
- **HNO**
- **Laminektomie**
- **Laparoskopie**
- **Mikromotoren-Systeme**
- **Proktoskopie**
- **Thorakoskopie**
- **Titan Platten Systeme**
- **Urologie**
- **Wirbelsäulen-Chirurgie**

Durch die enge Zusammenarbeit mit unseren Stamm-Lieferanten garantieren wir ein sehr hohes Qualitätsniveau.

Dies ist einer von vielen Gründen, die der Firma STEMA weltweit Kontakte zu verschiedenen Partner eröffnet, in unserem Namen sowie im OEM-Bereich.

Products

The current product range of STEMA Medizintechnik GmbH includes more than 10.000 different items.

We cover the following areas in surgery with high quality products:

- **Arthroscopy**
- **Bronchoscopy**
- **Cardiac MIS**
- **Container-Systems**
- **ENT**
- **Gastro-Intestinal**
- **Gynaecology**
- **HF-Surgery**
- **Laminectomy**
- **Laparoscopy**
- **Micro motor systems**
- **Proctoscopy**
- **Spine-Surgery**
- **Thoracoscopy**
- **Titanium plating system**
- **Units**
- **Urology**

A close cooperation with our suppliers guarantees a very high quality level.

This is one of many reasons which open STEMA contacts to various partners all over the world, in our name as well as on OEM base.

OPTIKEN / SCOPES

SEITE / PAGE

Autoklavierbare Optiken / Autoclavable scopes	8
Autoklavierbare HD Optiken / Autoclavable HD scopes	9
Autoklavierbare ULTRA HD Optiken / Autoclavable ULTRA HD scopes	10

ZYSTO-URETHROSKOPIE / CYSTO-URETHROSCOPY

Zysto-Urethroskopschäfte / Cysto-urethroscope sheaths	12
Obturatoren für Zysto-Urethroskopschäfte / Obturators for cysto-urethroscope sheaths	13
Endoskopbrücken / Endoscope bridges	14
Arbeitseinsätze mit Albarranhebel / Working elements with Albarran deflector	14

LASER ZYSTO-URETHROSKOPIE / LASER CYSTO-URETHROSCOPY

Zystoskop / Cystoscope	15
Laser Zysto-Urethroskopschäfte / Laser cysto-urethroscope sheaths	15
Obturatoren für Laser Zysto-Urethroskopschäfte / Obturators for laser cysto-urethroscope sheaths	15

SLIM ZYSTO-URETHROSKOPIE / SLIM CYSTO-URETHROSCOPY

Zystoskop / Cystoscope	16
Slim Zysto-Urethroskopschäfte / Slim cysto-urethroscope sheaths	16
Obturator für Slim Zysto-Urethroskopschäfte / Obturator for slim cysto-urethroscope sheaths	16
Endoskopbrücken / Endoscope bridges	17
Arbeitseinsätze mit Albarranhebel / Working elements with Albarran deflector	17
Optische Zangen und Scheren / Optical forceps and scissors	18-19
Instrumente (flexibel, halbstarr und starr) / Instruments (flexible, semi-rigid and rigid)	20-24
Steinfänger / Stone extractors	25
Diathermieschlingen / Diathermy loops	26
Flexible monopolare Elektroden und Anschlusskabel / Flexible monopolar electrodes and connecting cables	26-27
Mini HD Kompakt-Zystoskope / Mini HD compact cystoscopes	28
Flexibles Zystoskop und Zubehör / Flexible cystoscope and accessories	29-30

RESEKTOSKOPIE / RESECTOSCOPY

Dauerspül-Resektoskopschäfte / Continuous flow resectoscope sheaths	31-33
Laser Dauerspül-Resektoskopschäfte / Laser continuous flow resectoscope sheaths	32
Obturatoren für Dauerspül-Resektoskopschäfte / Obturators for continuous flow resectoscope sheaths	34
Arbeitselemente für Resektoskope / Working elements for resectoscopes	35-38
Laser Arbeitselemente für Resektoskope / Laser working elements for resectoscopes	38
Elektroden für Resektoskopie / Electrodes for resectoscopy	39
Zubehör / Accessories	39-40

SLIM RESEKTOSKOPIE / SLIM RESECTOSCOPY

Resektoskope / Resectoscopes	41-43
Slim Dauerspül-Resektoskopschäfte / Slim continuous flow resectoscope sheaths	41-43
Obturatoren für Slim Dauerspül-Resektoskopschäfte / Obturators for slim cont. flow resectoscope sheaths	41-43
Arbeitselemente für Slim Resektoskope / Working elements for slim resectoscopes	44-45
Elektroden für Slim Resektoskopie / Electrodes for slim resectoscopy	46
Zubehör / Accessories	46-47

MINI RESEKTOSKOPIE / MINI RESECTOSCOPY

Resektoskop / Resectoscope	48
Saliner Mini Dauerspül-Resektoskopschaft / Saline mini continuous flow resectoscope sheath	48
Obturator für Saline Mini Dauerspül-Resektoskopschaft / Obturator for saline mini continuous flow resectoscope sheath	48
Arbeitselement für Saline Mini Resektoskope / Working element for saline mini resectoscopes	49
Elektroden für Saline Mini Resektoskopie / Electrodes for saline mini resectoscopy	49
Zubehör / Accessories	49

SALINE MINI RESEKTOSKOPIE / SALINE MINI RESECTOSCOPY
SEITE / PAGE

Resektoskop / Resectoscope	50
Mini Dauerspül-Resektoskopschaft / Mini continous flow resectoscope sheath	50
Laser mini Dauerspül-Resektoskopschäfte / Laser mini continous flow resectoscope sheath	50
Obturator für Mini Dauerspül-Resektoskopschaft / Obturator for mini continous flow resectoscope sheath	50
Arbeitselement für Mini Resektoskope / Working element for mini resectoscopes	51
Elektroden für Mini Resektoskopie / Electrodes for mini resectoscopy	51
Zubehör / Accessories	51

SALINE RESEKTOSKOPIE / SALINE RESECTOSCOPY

Resektoskop / Resectoscope	52, 54
Saline Dauerspül-Resektoskopschäfte / Saline continous flow resectoscope sheaths	52, 54
Obturator für Saline Dauerspül-Resektoskopschäfte / Obturator for saline cont. flow resectoscope sheaths	52, 54
Arbeitselemente für Saline Resektoskope / Working elements for saline resectoscopes	53, 55
Elektroden für Saline Resektoskopie / Electrodes for saline resectoscopy	56
Zubehör / Accessories	57
Suprapubisches Aspirationsbesteck / Suprapubic aspiration set	58-59
Behältereinstecke / Tray inserts	60
Evakuator und Blasenspritzen / Evacuators and bladder syringes	61

MORCELLATION / MORCELLATION

Nephroskop / Nephroscope	62
Schäfte / Sheaths	63
Obturatoren / Obturators	63

URETHROTOMIE / URETHROTOMY

Otis Urethrotom / Otis urethrotom	64
Erstanzmesser / Spare knives	64

OPTISCHE URETHROTOMIE / OPTICAL URETHROTOMY

Zystoskop / Cystoscope	65
Urethrotomschäfte / Urethrotome sheaths	65
Obturatoren für Urethrotomschäfte / Obturators for urethrotome sheaths	66
Arbeitselemente für Urethrotome / Working elements for urethrotomes	67
Strikturskalpelle und Zubehör für Urethrotomie / Cold knives and accessories for urethrotomy	68

OPTISCHE SICHTURETHROTOMIE / OPTICAL VIEW URETHROTOMY

Zystoskop / Cystoscope	69
Urethrotomschäfte / Urethrotome sheaths	69
Obturator für Urethrotomschäfte / Obturator for urethrotome sheaths	69
Arbeitselemente für Urethrotome / Working elements for urethrotomes	70
Strikturskalpelle und Zubehör für Urethrotomie / Cold knives and accessories for urethrotomy	70

NEPHROSKOPIE / NEPHROSCOPY

Nephroskope / Nephroscopes	71, 73
HD Nephroskope / HD nephroscopes	77, 80
Mini-Nephroskope / Mini nephroscopes	79, 80
Nephroskopieschäfte / Nephroscope sheaths	72, 74
Nephroskopieschäfte für HD Nephroskope / Nephroscope sheaths for HD nephroscopes	77
Mini-Nephroskopieschäfte / Mini nephroscope sheaths	79
Obturatoren für Nephroskopieschäfte / Obturators for nephroscope sheaths	72, 74, 77
Teleskop-Bougies / Telescope bougies	75
Instrumente / Instruments	76, 78

URETERO-RENSKOPIE / URETERO-RENSCOPY

SEITE / PAGE

Uretero-Renskope / <i>Uretero-renoscopes</i>	81-83
HD Uretero-Renskope / <i>HD uretero-renoscopes</i>	84-87
Flexibles Uretero-Renskop und Zubehör / <i>Flexible uretero-renaloscope and accessories</i>	88-89
Instrumente (flexibel, halbstarr und starr) / <i>Instruments (flexible, semi-rigid and rigid)</i>	90-91
Instrumente zerlegbar / <i>Instruments detachable</i>	92-94
Steinfänger / <i>Stone extractors</i>	95
Diathermieschlingen / <i>Diathermy loops</i>	96
Flexible monopolare Elektroden und Anschlusskabel / <i>Flexible monopolar electrodes and connecting cables</i> ..	97

LITHOTRIPSIE / LITHOTRIPSY

Zystoskope / <i>Cystoscopes</i>	98
Lithotripsieschäfte / <i>Lithotripsy sheath</i>	98
Untersuchungsschäfte / <i>Diagnostic sheath</i>	98
Obturator / <i>Obturator</i>	98
Adaptor / <i>Adaptor</i>	99
Arbeitselemente / <i>Working elements</i>	99
Mechanischer Lithotriptor / <i>Mechanical lithotriptor</i>	99

OPTIKEN PÄDIATRIE / SCOPES PEDIATRICS

Autoklavierbare Optiken für die Pädiatrie / <i>Autoclavable scopes for pediatrics</i>	100
---	-----

PÄDIATRIE-ZYSTO-URETHROSKOPIE / PEDIATRIC-CYSTO-URETHROSCOPY

Pädiatrie-Zystoskope / <i>Pediatric-cystoscopes</i>	101-103
Pädiatrie-Zysto-Urethroskopschäfte / <i>Pediatric-cysto-urethroscope sheaths</i>	101-103
Obturatoren für Pädiatrie-Cysto-Urethroskopschäfte / <i>Obtulators for pediatric-cysto-urethroscope sheaths</i>	101-103
Endoskopbrücke / <i>Endoscope bridge</i>	103
Arbeitseinsatz mit Albarranhebel / <i>Working element with Albarran deflector</i>	103
Zangen (flexibel, halbstarr und starr) / <i>Forceps (flexible, semi-rigid and rigid)</i>	104
Flexible monopolare Elektroden und Anschlusskabel / <i>Flexible monopolar electrodes and connecting cables</i> ..	104-105

PÄDIATRIE RESEKTOSKOPIE / PEDIATRIC RESECTOSCOPY

Pädiatrie Resektoskope / <i>Pediatric resectoscopes</i>	106
Pädiatrie Resektoskopschäfte / <i>Pediatric resectoscope sheaths</i>	106
Obturatoren für Pädiatrie Resektoskopschäfte / <i>Obtulators for pediatric resectoscope sheaths</i>	106
Endoskopbrücke / <i>Endoscope bridge</i>	107
Arbeitselemente für Pädiatrie Resektoskopie / <i>Working elements for pediatric resectoscopy</i>	107
Elektroden und Zubehör / <i>Electrodes and accessories</i>	108
Anschlusskabel / <i>Connecting cables</i>	109

PÄDIATRIE URETHROTOMIE / PEDIATRIC URETHROTOMY

Pädiatrie Zystoskope / <i>Pediatric cystoscopes</i>	110
Pädiatrie Urethrotomschäfte / <i>Pediatric urethrotome sheaths</i>	110
Obturatoren für Pädiatrie Urethrotomschäfte / <i>Obtulators for pediatric urethrotome sheaths</i>	110
Endoskopbrücke / <i>Endoscope bridge</i>	111
Arbeitselemente für Pädiatrie Urethroskopie / <i>Working elements for pediatric urethroscopy</i>	111
Strikturskalpelle und Zubehör / <i>Cold knives and accessories</i>	112
Anschlusskabel / <i>Connecting cables</i>	113

INSTRUMENTE / INSTRUMENTS

Dilatationsbougies / <i>Dilating bougies</i>	114
Metallkatheter / <i>Metal catheters</i>	115
Katheterspanner und Klemmen / <i>Catheter introducer and clamps</i>	116
Sekretlöffel und Schlauchverbinder / <i>Secretion spoon and tubing connectors</i>	116

STERILISATION / STERILIZATION

SEITE / PAGE

Siebkörbe für Endoskope / <i>Wire baskets for endoscopes</i>	117
Endoskop-Container / <i>Endoscope containers</i>	118

REINIGUNG - PFLEGE / CLEANING - MAINTENANCE

Reinigungspistole und Bürsten / <i>Cleaning pistol and brushes</i>	119
Spezialfett und Polierpaste / <i>Special grease and polishing paste</i>	119

OPTIKEN HYSTEROSKOPIE / SCOPES HYSTERSOCOPY

Autoklavierbare Optiken / <i>Autoclavable scopes</i>	122, 124
Autoklavierbare HD Optiken / <i>Autoclavable HD scopes</i>	123

DIAGNOSTISCHE HYSTEROSKOPIE / DIAGNOSTIC HYSTEROSCOPY

Hysteroskope / <i>Hysteroscopes</i>	125-130
Hysteroskopieschäfte / <i>Hysteroscopy sheaths</i>	125-130
HIGH-FLOW Hysteroskopieschäfte / <i>HIGH-FLOW hysteroscopy sheaths</i>	131-132
Obturatoren für Hysteroskopieschäfte / <i>Obturator for hysteroscopy sheaths</i>	125-130
Instrumente (flexibel, halbstarr und starr) / <i>Instruments (flexible, semi-rigid and rigid)</i>	133-135
Diathermieschlingen / <i>Diathermy loops</i>	136
Flexible monopolare Elektroden und Anschlusskabel / <i>Flexible monopolar electrodes and connecting cables..</i>	136-137
Flexible bipolare Elektroden und Anschlusskabel / <i>Flexible bipolar electrodes and connecting cables</i>	138-139

INSTRUMENTE / INSTRUMENTS

Cohen Intra-Uterinsonde / <i>Cohen intra uterine probe</i>	140
Uterusmanipulatoren / <i>Uterus manipulators</i>	141-143
Myombohrer / <i>Myoma drills</i>	143
Ringapplikatoren / <i>Ring applicators</i>	144
Hakenzangen / <i>Tenaculum forceps</i>	145
Uterussonden / <i>Uterine probes</i>	145
Biopsieküretten / <i>Biopsy curettes</i>	146
Sekretlöffel / <i>Secretion spoon</i>	146
Uterusdilatoren-Set / <i>Uterine dilatation set</i>	146
Portio Adapter / <i>Portio cervix</i>	146
Biopsiestanzen / <i>Biopsy punches</i>	147
Instrumente mit Federgriff / <i>Instruments with spring handle</i>	148
Retraktoren / <i>Retractors</i>	149

AMNIOSKOPIE / AMNIOSCOPY

Amnioskopie Tuben / <i>Amnioscope tubes</i>	150
Kaltlichtklammer / <i>Fibre optic clamp</i>	150
Tupferhalter / <i>Sponge holder</i>	151
Skalpellhalter / <i>Scalpell holder</i>	151
Klinge spitz / <i>Pointed blade</i>	151

SETVORSCHLÄGE / SET RECOMMENDATIONS

Zysto-Urethroskopie-Set / <i>Cysto-urethroscopy set</i>	152
Resektoskopie-Set (monopolar) / <i>Resectoscopy set (monopolar)</i>	153
Resektoskopie-Set (Saline/bipolar) / <i>Resectoscopy set (Saline/bipolar)</i>	154
Optisches Urethrotomie-Set / <i>Optical urethrotomy set</i>	155
Diagnostik Hysteroskopie-Set / <i>Diagnostic hysteroscopy set</i>	156
Operatives Hysteroskopie-Set / <i>Operative hysteroscopy set</i>	157
Ambulantes atraumatisches OP-Hysteroskopie-Set / <i>Out-patient atraumatic OR hysteroscopy set</i>	158

GERÄTE / UNITS

Spülpumpen / <i>Irrigation pumps</i>	159
Zubehör für Spülpumpen / <i>Accessories for irrigation pumps</i>	160

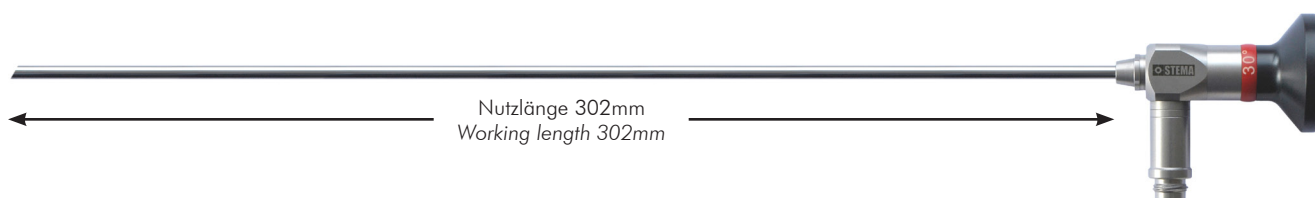

Bestell-Nr. Ordering no.	Durchmesser Diameter	Blickrichtung Direction of view	Farbmarkierung Colour code
AA-001-001	2.7mm	0°	Grün Green
AA-001-002	2.7mm	12°	Weiß White
AA-001-003	2.7mm	30°	Rot Red
AA-001-004	2.7mm	70°	Gelb Yellow
AA-003-001	2.9mm	0°	Grün Green
AA-003-004	2.9mm	12°	Weiß White
AA-003-002	2.9mm	30°	Rot Red
AA-003-002-W	2.9mm	30° - Weitwinkel 30° - Wide angle	Rot Red
AA-003-003	2.9mm	70°	Gelb Yellow
AA-002-001	4.0mm	0°	Grün Green
AA-002-001-W	4.0mm	0° - Weitwinkel 0° - Wide angle	Grün Green
AA-002-002	4.0mm	12°	Weiß White
AA-002-003	4.0mm	30°	Rot Red
AA-002-003-W	4.0mm	30° - Weitwinkel 30° - Wide angle	Rot Red
AA-002-004	4.0mm	70°	Gelb Yellow
AA-002-004-W	4.0mm	70° - Weitwinkel 70° - Wide angle	Gelb Yellow

STEMA High Definition

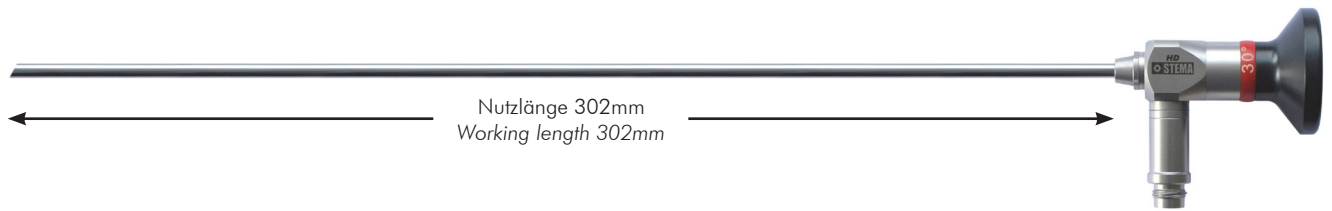

Bestell-Nr. Ordering no.	Durchmesser Diameter	Blickrichtung Direction of view	Farbmarkierung Colour code
AA-001-011	2.7mm	0°	Grün Green
AA-001-012	2.7mm	12°	Weiß White
AA-001-013	2.7mm	30°	Rot Red
AA-001-014	2.7mm	70°	Gelb Yellow
AA-003-011	2.9mm	0°	Grün Green
AA-003-014	2.9mm	12°	Weiß White
AA-003-012	2.9mm	30°	Rot Red
AA-003-012-W	2.9mm	30° - Weitwinkel 30° - Wide angle	Rot Red
AA-002-011	4.0mm	0°	Grün Green
AA-002-011-W	4.0mm	0° - Weitwinkel 0° - Wide angle	Grün Green
AA-002-012	4.0mm	12°	Weiß White
AA-002-013	4.0mm	30°	Rot Red
AA-002-013-W	4.0mm	30° - Weitwinkel 30° - Wide angle	Rot Red
AA-002-014	4.0mm	70°	Gelb Yellow
AA-002-014-W	4.0mm	70° - Weitwinkel 70° - Wide angle	Gelb Yellow

STEMA **ULTRA High Definition - 4K**

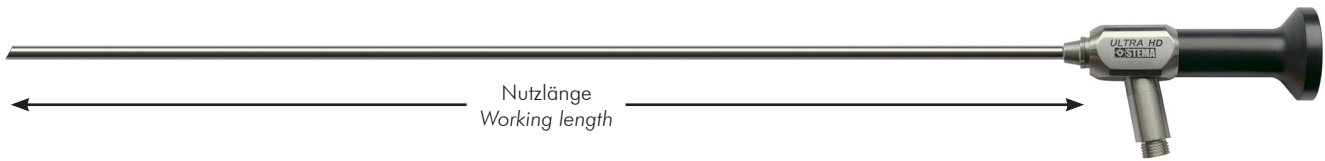

Bestell-Nr. Ordering no.	Durchmesser Diameter	Blickrichtung Direction of view	Farbmarkierung Colour code
AA-002-021	4mm	0°	Grün Green
AA-002-022	4mm	12°	Weiß White
AA-002-023	4mm	30°	Rot Red
AA-002-024	4mm	70°	Gelb Yellow



Bestell-Nr. Ordering no.	Farbmarkierung Colour code	
AB-001-002	Gelb Yellow	Zysto-Urethroskopschaft 17 Charr. mit 2 starren Hähnen, mit Obturator Cysto-Urethroscope sheath 17 Fr. with 2 fixed stopcock, with obturator
AB-001-003	Grün Green	Zysto-Urethroskopschaft 19 Charr. mit 2 starren Hähnen, mit Obturator Cysto-Urethroscope sheath 19 Fr. with 2 fixed stopcock, with obturator
AB-001-004	Rot Red	Zysto-Urethroskopschaft 21 Charr. mit 2 starren Hähnen, mit Obturator Cysto-Urethroscope sheath 21 Fr. with 2 fixed stopcock, with obturator
AB-001-005	Blau Blue	Zysto-Urethroskopschaft 23 Charr. mit 2 starren Hähnen, mit Obturator Cysto-Urethroscope sheath 23 Fr. with 2 fixed stopcock, with obturator
AB-001-006	Weiss White	Zysto-Urethroskopschaft 25 Charr. mit 2 starren Hähnen, mit Obturator Cysto-Urethroscope sheath 25 Fr. with 2 fixed stopcock, with obturator



Bestell-Nr. Ordering no.	Farbmarkierung Colour code	
AB-002-001	Gelb Yellow	Zysto-Urethroskopschaft 17 Charr. mit Zentralhahn, mit Obturator Cysto-Urethroscope sheath 17 Fr. with central valve, with obturator
AB-002-002	Grün Green	Zysto-Urethroskopschaft 19 Charr. mit Zentralhahn, mit Obturator Cysto-Urethroscope sheath 19 Fr. with central valve, with obturator
AB-002-003	Rot Red	Zysto-Urethroskopschaft 21 Charr. mit Zentralhahn, mit Obturator Cysto-Urethroscope sheath 21 Fr. with central valve, with obturator
AB-002-004	Blau Blue	Zysto-Urethroskopschaft 23 Charr. mit Zentralhahn, mit Obturator Cysto-Urethroscope sheath 23 Fr. with central valve, with obturator
AB-002-005	Weiß White	Zysto-Urethroskopschaft 25 Charr. mit Zentralhahn, mit Obturator Cysto-Urethroscope sheath 25 Fr. with central valve, with obturator



Info: Alle Schäfte sind ebenfalls in der Ausführung „Klick-System“ erhältlich. Bitte kontaktieren Sie uns einfach.
Info: All sheaths are also available as „Click-System“ versions. Please just contact us.



Bestell-Nr. Ordering no.	Farbmarkierung Colour code	
AB-001-012	Gelb Yellow	Standardobturator für Zysto-Urethroskopschäfte 17 Charr. Standardobturator Cysto-Urethroscope sheath 17 Fr.
AB-001-013	Grün Green	Standardobturator für Zysto-Urethroskopschäfte 19 Charr. Standardobturator Cysto-Urethroscope sheath 19 Fr.
AB-001-014	Rot Red	Standardobturator für Zysto-Urethroskopschäfte 21 Charr. Standardobturator Cysto-Urethroscope sheath 21 Fr.
AB-001-015	Blau Blue	Standardobturator für Zysto-Urethroskopschäfte 23 Charr. Standardobturator Cysto-Urethroscope sheath 23 Fr.
AB-001-016	Weiss White	Standardobturator für Zysto-Urethroskopschäfte 25 Charr. Standardobturator Cysto-Urethroscope sheath 25 Fr.



Bestell-Nr. Ordering no.	Farbmarkierung Colour code	
AB-001-022	Gelb Yellow	Sichtobturator für Zysto-Urethroskopschäfte 17 Charr. Viewing obturator Cysto-Urethroscope sheath 17 Fr.
AB-001-023	Grün Green	Sichtobturator für Zysto-Urethroskopschäfte 19 Charr. Viewing obturator Cysto-Urethroscope sheath 19 Fr.
AB-001-024	Rot Red	Sichtobturator für Zysto-Urethroskopschäfte 21 Charr. Viewing obturator Cysto-Urethroscope sheath 21 Fr.
AB-001-025	Blau Blue	Sichtobturator für Zysto-Urethroskopschäfte 23 Charr. Viewing obturator Cysto-Urethroscope sheath 23 Fr.
AB-001-026	Weiss White	Sichtobturator für Zysto-Urethroskopschäfte 25 Charr. Viewing obturator Cysto-Urethroscope sheath 25 Fr.



Bestell-Nr. Ordering no.	
AB-001-010	Zystoskop Adapter für Urethroskopie bei Frauen Cystoscope adaptor for female urethroscopy

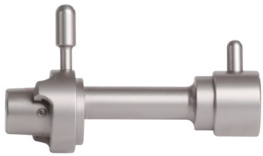

AB-003-002

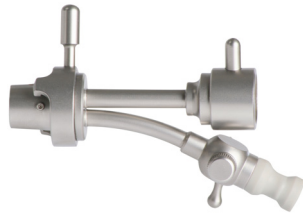

AB-003-003

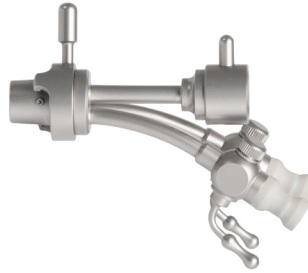

AB-003-004

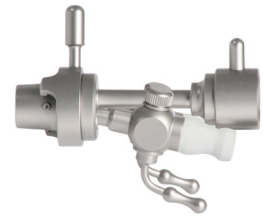

AB-003-015

Bestell-Nr.
Ordering no.

AB-003-002	Endoskopbrücke, Diagnose <i>Endoscope bridge, diagnostic</i>
AB-003-003	Endoskopbrücke mit 1 Instrumentenkanal <i>Endoscope bridge with 1 instrument channel</i>
AB-003-004	Endoskopbrücke mit 2 Instrumentenkanäle <i>Endoscope bridge with 2 instrument channels</i>
AB-003-015	Endoskopbrücke mit 2 Instrumentenkanäle, kurz <i>Endoscope bridge with 2 instrument channels, short</i>

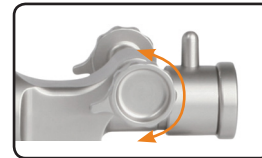
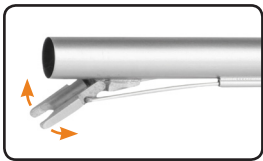

AB-003-006 /
AB-003-008



AB-003-007 /
AB-003-009

Bestell-Nr.
Ordering no.

AB-003-006	Arbeitseinsatz mit Albarranhebel und 1 Instrumentenkanal <i>Working element with Albarran deflector and 1 instrument channel</i>
AB-003-007	Arbeitseinsatz mit Albarranhebel und 2 Instrumentenkanälen <i>Working element with Albarran deflector and 2 instrument channels</i>
AB-003-008	Arbeitseinsatz mit Albarranhebel und 1 Instrumentenkanal, ohne Raste <i>Working element with Albarran deflector and 1 instrument channel, without ratchet</i>
AB-003-009	Arbeitseinsatz mit Albarranhebel und 2 Instrumentenkanälen, ohne Raste <i>Working element with Albarran deflector and 2 instrument channels, without ratchet</i>



Bestell-Nr.
Ordering no.

AA-002-003	Zystoskop Ø 4.0mm, Blickwinkel 30° autoklavierbar <i>Cystoscope Ø 4.0mm, 30° viewing angle, autoclavable</i>
AA-002-013	HD Zystoskop Ø 4.0mm, Blickwinkel 30° autoklavierbar HD <i>Cystoscope Ø 4.0mm, 30° viewing angle, autoclavable</i>
AA-002-023	Ultra HD Zystoskop Ø 4.0mm, Blickwinkel 30° autoklavierbar Ultra HD <i>Cystoscope Ø 4.0mm, 30° viewing angle, autoclavable</i>



Bestell-Nr.
Ordering no.

Bestell-Nr. Ordering no.	Farbmarkierung Colour code	
AB-001-040	Blau <i>Blue</i>	LASER Zysto-Urethroskopaussenshaft 23 Charr. mit 2 starren Hähnen für 30° Optik <i>LASER Cysto-Urethroscope outer sheath 23 Fr. with 2 fixed stopcock used for 30° endoscope</i>



Bestell-Nr.
Ordering no.

Bestell-Nr. Ordering no.	Farbmarkierung Colour code	
AB-001-041	Blau <i>Blue</i>	LASER Zysto-Urethroskopinnenshaft mit 8 Charr. Arbeitskanal <i>LASER Cysto-Urethroscope inner sheath with 8 Fr. working channel</i>



AB-001-042



AB-001-043

Bestell-Nr.
Ordering no.

Bestell-Nr. Ordering no.	Farbmarkierung Colour code	
AB-001-042	Blau <i>Blue</i>	Sichtobturator für Zysto-Urethroskopschaft AB-001-040 <i>Viewing obturator for Cysto-Urethroscope sheath AB-001-040</i>
AB-001-043	Blau <i>Blue</i>	Obturator für Zysto-Urethroskopschaft AB-001-040 <i>Obturator for Cysto-Urethroscope sheath AB-001-040</i>



**Bestell-Nr.
 Ordering no.**

AA-003-002	Zystoskop Ø 2.9mm, Blickwinkel 30°, autoklavierbar Cystoscope Ø 2.9mm, 30° viewing angle, autoclavable
AA-003-012	HD Zystoskop Ø 2.9mm, Blickwinkel 30°, autoklavierbar HD Cystoscope Ø 2.9mm, 30° viewing angle, autoclavable
AA-003-012-W	HD Zystoskop Ø 2.9mm, Weitwinkel, Blickwinkel 30°, autoklavierbar HD Cystoscope Ø 2.9mm, wide angle, 30° viewing angle, autoclavable



**Bestell-Nr.
 Ordering no.** **Farbmarkierung
 Colour code**

AB-001-007	Schwarz Black	Zysto-Urethroskopschaft 15 Charr. mit 2 starren Hähnen, 5 Charr. Instrumentenkanal, inkl. Obturator Cysto-Urethroscope sheath 15 Fr. with 2 fixed stopcock, 5 Fr. instrument channel, incl. obturator
-------------------	------------------	--



**Bestell-Nr.
 Ordering no.** **Farbmarkierung
 Colour code**

AB-001-000	Schwarz Black	Zysto-Urethroskopschaft 16 Charr. mit 2 starren Hähnen, Quick-Lock, inkl. Obturator Cysto-Urethroscope sheath 16 Fr. with 2 fixed stopcock, Quick-Lock, incl. obturator
-------------------	------------------	--

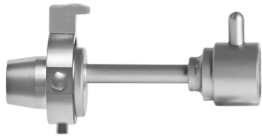

AB-003-010

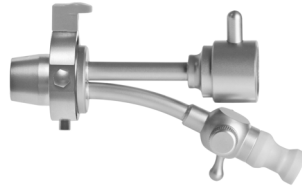

AB-003-011

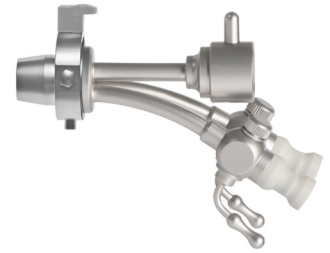

AB-003-012

Bestell-Nr.
Ordering no.

AB-003-010	Endoskopbrücke, Diagnose für 16 Charr. Schaft <i>Endoscope bridge, diagnostic used for 16 Fr. sheath</i>
AB-003-011	Endoskopbrücke mit 1 Instrumentenkanal für 16 Charr. Schaft <i>Endoscope bridge with 1 instrument channel used for 16 Fr. sheath</i>
AB-003-012	Endoskopbrücke mit 2 Instrumentenkanälen für 16 Charr. Schaft <i>Endoscope bridge with 2 instrument channels used for 16 Fr. sheath</i>

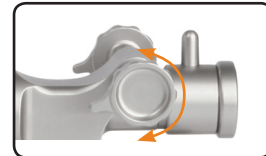
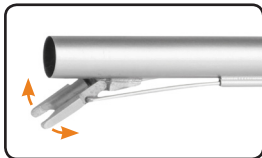

AB-003-013

Bestell-Nr.
Ordering no.

AB-003-013	Arbeitseinsatz mit Albarranhebel und 1 Instrumentenkanal für 16 Charr. Schaft, Quick-Lock <i>Working element with Albarran deflector and 1 instrument channel used for 16 Fr. sheath</i>
AB-003-014	Arbeitseinsatz mit Albarranhebel und 2 Instrumentenkanälen für 16 Charr. Schaft <i>Working element with Albarran deflector and 2 instrument channels used for 16 Fr. sheath</i>



Bestell-Nr.
Ordering no.

AB-003-020	Füllstab für Arbeitseinsätze mit Albarranhebel <i>Protective rod for working elements with Albarran deflector</i>
-------------------	--

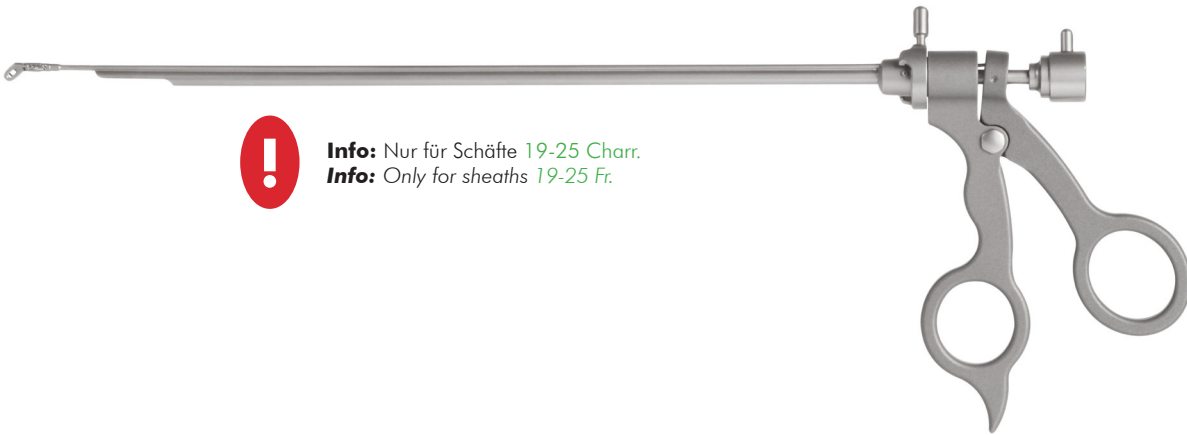



Info: Nur für Schäfte 19-25 Charr.
Info: Only for sheaths 19-25 Fr.









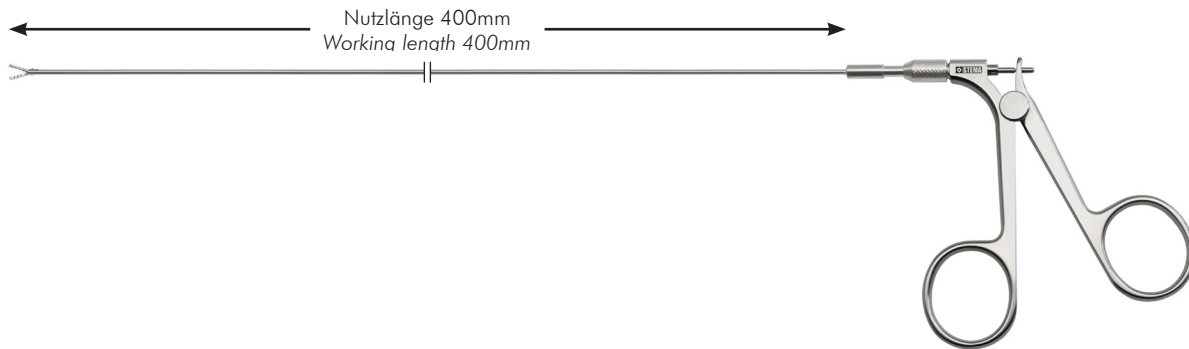

	Bestell-Nr. Ordering no.	Für Optiken For scopes	
	AB-004-005	12° / 30°	Biopsiefäßzange (unten), doppelbeweglich Biopsy forceps (down), double action
	AB-004-006	70°	Biopsiefäßzange (unten), doppelbeweglich Biopsy forceps (down), double action
	AB-004-001	0° / 12° / 30°	Probeexzisionszange, doppelbeweglich Biopsy forceps, double action
	AB-004-002	0° / 12°	Probeexzisionszange, durchschneidend Biopsy forceps, through cutting
	AB-004-004	0° / 12°	Hakenschere, doppelbeweglich Hook scissors, double action
	AB-004-010	0° / 12°	Faßzange, beidseitig öffnend, zur Entfernung von Stents Forceps, double action, for removal fo stents
	AB-004-003	0° / 12°	Fasszange, doppelbeweglich Grasping forceps, double action
	AB-004-008		Adapter für den Einsatz mit Resektoskopschäften Adapter for use with resectoscope sheaths



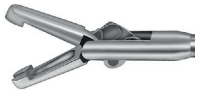



Info: Nur für Schäfte 25 Charr.
Info: Only for sheaths 25 Fr.

	Bestell-Nr. Ordering no.	Für Optiken For scopes	
	AB-004-007	0° / 12° / 30°	Optische Steinzange <i>Optical stone punch</i>
	AB-004-009		Adapter für den Einsatz mit Resektoskopschäften 26 - 28.5 Charr. <i>Adaptor for use with resectoscope sheaths 26 - 28.5 Fr.</i>
	AB-004-009-QL		Adapter für den Einsatz mit Resektoskopschäften 26 - 28.5 Charr. STEMA Click-System <i>Adaptor for use with resectoscope sheaths 26 - 28.5 Fr.</i> STEMA Click-System

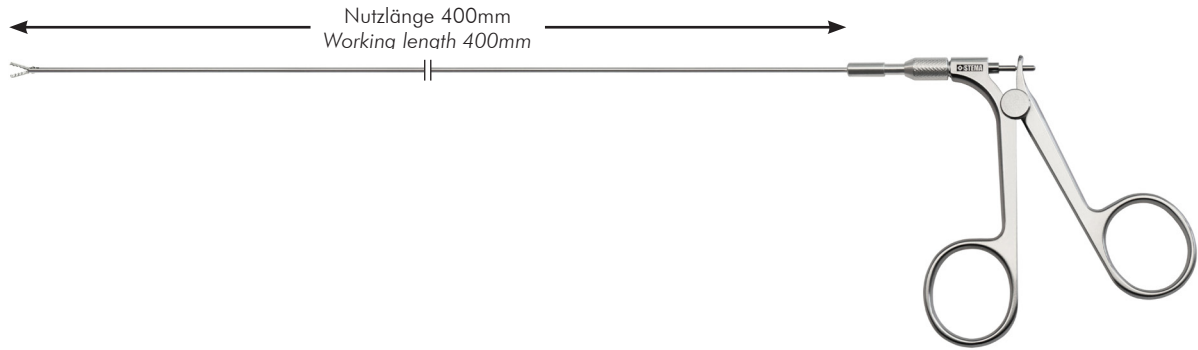



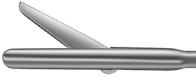



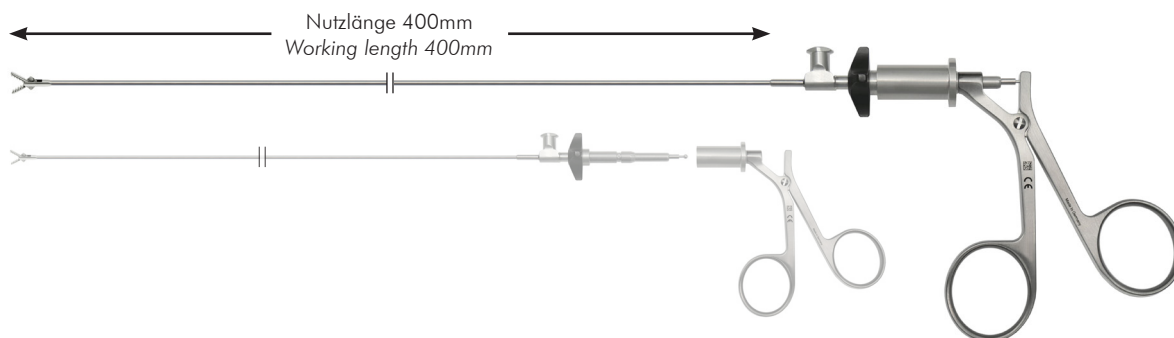



		Ømm	Charr. Fr.	Flexibel Flexible	Halbstarr Semi-rigid	Starr Rigid
 Probeexzisionszange oval, doppelbeweglich <i>Biopsy forceps oval, double action</i>		1.0	3	AC-001-001	AC-001-201	AC-001-001-R
		1.6	5	AC-001-002	AC-001-202	AC-001-002-R
		2.1	6	AC-001-003	AC-001-203	AC-001-003-R
		2.3	7	AC-001-004	AC-001-204	AC-001-004-R
		3.0	9	AC-001-005	AC-001-205	AC-001-005-R
 Probeexzisionszange oval, gezahnt, doppelbeweglich <i>Biopsy forceps oval, serrated, double action</i>		1.0	3	AC-002-001	AC-002-201	AC-002-001-R
		1.6	5	AC-002-002	AC-002-202	AC-002-002-R
		2.1	6	AC-002-003	AC-002-203	AC-002-003-R
		2.3	7	AC-002-004	AC-002-204	AC-002-004-R
		3.0	9	AC-002-005	AC-002-205	AC-002-005-R
 Probeexzisionszange oval, gezahnt, Zähne ineinandergreifend, doppelbeweglich <i>Biopsy forceps oval, serrated, teeth interlock, double action</i>		1.6	5	AC-015-002	AC-015-202	AC-015-002-R
		2.1	6		AC-015-203	AC-015-003-R
		2.3	7	AC-015-004	AC-015-204	AC-015-004-R
 Fremdkörperzange, doppelbeweglich <i>Grasping forceps for stone street, double action</i>		1.2	4	AC-017-001	AC-017-201	AC-017-001-R
		2.3	7	AC-017-004	AC-017-204	AC-017-004-R
 Fasszange Alligatormaul, doppelbeweglich <i>Grasping forceps alligator jaw, double action</i>		1.0	3	AC-006-001	AC-006-201	AC-006-001-R
		1.2	4	AC-006-003	AC-006-203	AC-006-003-R
		1.6	5	AC-006-002	AC-006-202	AC-006-002-R
		2.3	7	AC-006-004	AC-006-204	AC-006-004-R
		3.0	9	AC-006-005	AC-006-205	AC-006-005-R
 Fasszange DJ, doppelbeweglich <i>Grasping forceps DJ, double action</i>		2.3	7	AC-008-004	AC-008-204	AC-008-004-R
		3.0	9	AC-008-005	AC-008-205	AC-008-005-R
 Fasszange gezahnt, doppelbeweglich <i>Grasping forceps teeth, double action</i>		1.2	4	AC-016-001	AC-016-201	AC-016-001-R
		1.6	5	AC-016-002	AC-016-202	AC-016-002-R
 Fasszange Zähne ineinander, doppelbeweglich <i>Grasping forceps teeth interlock, double action</i>		1.6	5	AC-020-002	AC-020-202	AC-020-002-R
		2.3	7	AC-020-004	AC-020-204	AC-020-004-R
 Fasszange Rattenzahn, doppelbeweglich <i>Grasping forceps rat tooth, double action</i>		1.0	3	AC-019-001	AC-019-201	AC-019-001-R
		1.6	5	AC-019-002	AC-019-202	AC-019-002-R
 Fasszange für Steinstrasse, doppelbeweglich <i>Grasping forceps for stone street, double action</i>		1.2	4	AC-007-001	AC-007-201	AC-007-001-R
		1.6	5	AC-007-002	AC-007-202	AC-007-002-R
 Fasszange für große Steine, doppelbeweglich <i>Grasping forceps for big stones, double action</i>		1.2	4	AC-009-001	AC-009-201	AC-009-001-R
		1.6	5	AC-009-002	AC-009-202	AC-009-002-R
		2.3	7	AC-009-004	AC-009-204	AC-009-004-R
 Dreiarmergreifer 3-Prongs retriever		1.0	3	AC-012-001		
		1.6	5	AC-012-002		
		2.3	7	AC-012-004		







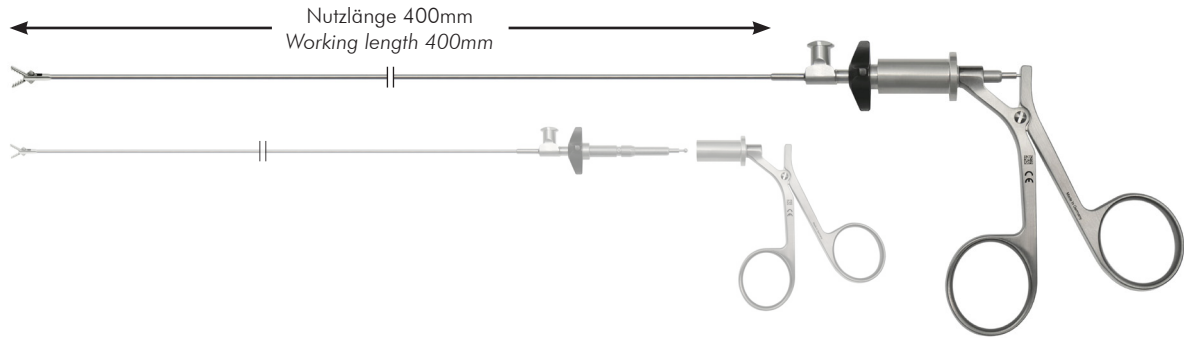

		Ømm	Charr. Fr.	Flexibel Flexible	Halbstarr Semi-rigid	Starr Rigid
	Schere gezahnt, doppelbeweglich Scissors serrated flexible, double action	2.3	7	AC-005-004	AC-005-204	AC-005-004-R
	Schere, einfachbeweglich Scissors, single action	1.0	3	AC-003-000	AC-003-200	AC-003-000-R
		1.2	4	AC-003-001	AC-003-201	AC-003-001-R
		1.6	5	AC-003-002	AC-003-202	AC-003-002-R
		2.1	6	AC-003-003	AC-003-203	AC-003-003-R
		2.3	7	AC-003-004	AC-003-204	AC-003-004-R
		3.0	9	AC-003-005	AC-003-205	AC-003-005-R
	Ureter-Schlitzschere, einfachbeweglich Uretero slitting scissors, single action	1.2	4		AC-018-201	AC-018-001-R
		1.6	5		AC-018-202	AC-018-002-R
	Schere spitz, einfachbeweglich Scissors pointed, single action	1.6	5		AC-003-302	
		2.3	7		AC-003-304	
	Hakenschere, einfachbeweglich Hook scissors, single action	2.3	7	AC-004-004	AC-004-204	AC-004-004-R
		3.0	9	AC-004-005	AC-004-205	AC-004-005-R



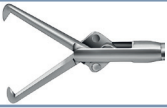





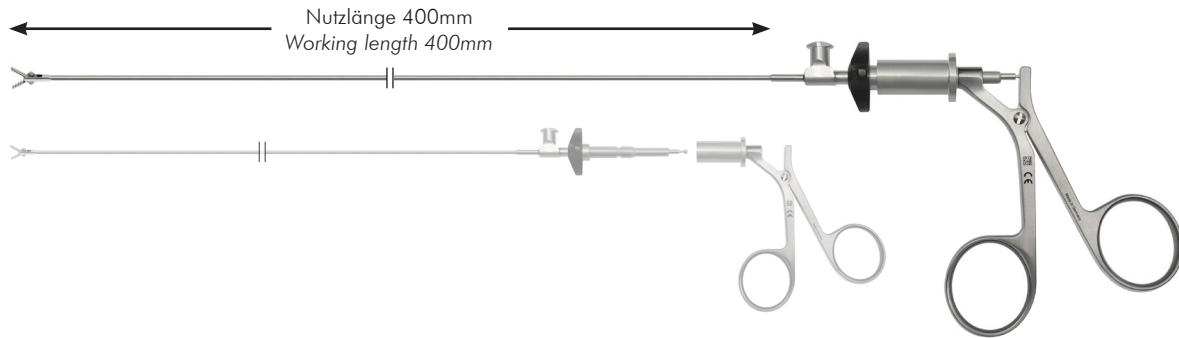

		Ømm	Charr. Fr.	Komplett Complete	Einsatz Insert	Griff Handle
 Probeexzisionszange oval, doppelbeweglich <i>Biopsy forceps oval, double action</i>		1.0	3	AC-001-001-T	AC-001-001-OT	AC-100-001
		1.2	4	AC-001-006-T	AC-001-006-OT	
		1.6	5	AC-001-002-T	AC-001-002-OT	
		2.3	7	AC-001-004-T	AC-001-004-OT	
		3.0	9	AC-001-005-T	AC-001-005-OT	
 Fasszange gezahnt, doppelbeweglich <i>Grasping forceps teeth, double action</i>		1.2	4	AC-016-001-T	AC-016-001-OT	AC-100-001
		1.6	5	AC-016-002-T	AC-016-002-OT	
 Fasszange Alligatormaul, doppelbeweglich <i>Grasping forceps alligator jaw, double action</i>		1.0	3	AC-006-001-T	AC-006-001-OT	AC-100-001
		1.2	4	AC-006-003-T	AC-006-003-OT	
		1.6	5	AC-006-002-T	AC-006-002-OT	
		2.3	7	AC-006-004-T	AC-006-004-OT	
		3.0	9	AC-006-005-T	AC-006-005-OT	
 Fasszange für Steinstrasse, doppelbeweglich <i>Grasping forceps for stone street, double action</i>		1.2	4	AC-007-001-T	AC-007-001-OT	AC-100-001
		1.6	5	AC-007-002-T	AC-007-002-OT	
 Fasszange Rattenzahn, doppelbeweglich <i>Grasping forceps rat tooth, double action</i>		1.0	3	AC-019-001-T	AC-019-001-OT	AC-100-001
		1.2	4	AC-019-000-T	AC-019-000-OT	
		1.6	5	AC-019-002-T	AC-019-002-OT	
 Fasszange für große Steine, doppelbeweglich <i>Grasping forceps for big stones, double action</i>		1.2	4	AC-009-001-T	AC-009-001-OT	AC-100-001
		1.6	5	AC-009-002-T	AC-009-002-OT	
 Schere, einfachbeweglich <i>Scissors, single action</i>		1.0	3	AC-003-000-T	AC-003-000-OT	AC-100-001
		1.2	4	AC-003-001-T	AC-003-001-OT	
		1.6	5	AC-003-002-T	AC-003-002-OT	
		2.3	7	AC-003-004-T	AC-003-004-OT	
		3.0	9	AC-003-005-T	AC-003-005-OT	
 Schere spitz, einfachbeweglich <i>Scissors pointed, single action</i>		1.6	5	AC-003-402-T	AC-003-402-OT	AC-100-001
 Hakenschere, einfachbeweglich <i>Hook scissors, single action</i>		2.3	7	AC-004-004-T	AC-004-004-OT	AC-100-001
		3.0	9	AC-004-005-T	AC-004-005-OT	
 Biopsiestanze, einfachbeweglich <i>Biopsy punch forceps, single action</i>		1.6	5	AC-014-002-T	AC-014-002-OT	AC-100-001



	Ømm	Charr. Fr.	Komplett Complete	Einsatz Insert	Griff Handle
 Probeexzisionszange oval, doppelbeweglich <i>Biopsy forceps oval, double action</i>	1.0	3	AC-001-201-T	AC-001-201-OT	AC-100-001
	1.2	4	AC-001-206-T	AC-001-206-OT	
	1.6	5	AC-001-202-T	AC-001-202-OT	
	2.3	7	AC-001-203-T	AC-001-203-OT	
	3.0	9	AC-001-204-T	AC-001-204-OT	
 Fasszange Alligatormaul, doppelbeweglich <i>Grasping forceps alligator jaw, double action</i>	1.0	3	AC-006-201-T	AC-006-201-OT	AC-100-001
	1.2	4	AC-006-203-T	AC-006-203-OT	
	1.6	5	AC-006-202-T	AC-006-202-OT	
	2.3	7	AC-006-204-T	AC-006-204-OT	
	3.0	9	AC-006-205-T	AC-006-205-OT	
 Fasszange für Steinstrasse, doppelbeweglich <i>Grasping forceps for stone street, double action</i>	1.2	4	AC-007-201-T	AC-007-201-OT	AC-100-001
	1.6	5	AC-007-202-T	AC-007-202-OT	
 Fasszange für große Steine, doppelbeweglich <i>Grasping forceps for big stones, double action</i>	1.2	4	AC-009-201-T	AC-009-201-OT	AC-100-001
 Schere, einfachbeweglich <i>Scissors, single action</i>	1.0	3	AC-003-200-T	AC-003-200-OT	AC-100-001
	1.2	4	AC-003-201-T	AC-003-201-OT	
	1.6	5	AC-003-202-T	AC-003-202-OT	
	2.3	7	AC-003-204-T	AC-003-204-OT	
	3.0	9	AC-003-205-T	AC-003-205-OT	
 Schere spitz, einfachbeweglich <i>Scissors pointed, single action</i>	1.6	5	AC-003-612-T	AC-003-612-OT	AC-100-001
	2.3	7	AC-003-614-T	AC-003-614-OT	
 Hakenschere, einfachbeweglich <i>Hook scissors, single action</i>	2.3	7	AC-004-204-T	AC-204-004-OT	AC-100-001
	3.0	9	AC-004-205-T	AC-004-205-OT	
 Biopsiestanze, einfachbeweglich <i>Biopsy punch forceps, single action</i>	1.6	5	AC-014-202-T	AC-014-202-OT	AC-100-001



		Ømm	Charr. Fr.	Komplett Complete	Einsatz Insert	Griff Handle
 Probeexzisionszange oval, doppelbeweglich <i>Biopsy forceps oval, double action</i>		1.0	3	AC-101-201-T	AC-101-201-OT	AC-100-001
		1.2	4	AC-101-206-T	AC-101-206-OT	
		1.6	5	AC-101-202-T	AC-101-202-OT	
		2.3	7	AC-101-203-T	AC-101-203-OT	
		3.0	9	AC-101-204-T	AC-101-204-OT	
 Fasszange Alligatormaul, doppelbeweglich <i>Grasping forceps alligator jaw, double action</i>		1.0	3	AC-106-201-T	AC-006-201-OT	AC-100-001
		1.2	4	AC-106-203-T	AC-006-203-OT	
		1.6	5	AC-106-202-T	AC-006-202-OT	
		2.3	7	AC-106-204-T	AC-006-204-OT	
		3.0	9	AC-106-205-T	AC-006-205-OT	
 Fasszange für Steinstrasse, doppelbeweglich <i>Grasping forceps for stone street, double action</i>		1.2	4	AC-107-201-T	AC-107-201-OT	AC-100-001
		1.6	5	AC-107-202-T	AC-107-202-OT	
 Fasszange für große Steine, doppelbeweglich <i>Grasping forceps for big stones, double action</i>		1.2	4	AC-109-201-T	AC-109-201-OT	AC-100-001
 Schere, einfachbeweglich <i>Scissors, single action</i>		1.0	3	AC-103-200-T	AC-103-200-OT	AC-100-001
		1.2	4	AC-103-201-T	AC-103-201-OT	
		1.6	5	AC-103-202-T	AC-103-202-OT	
		2.3	7	AC-103-204-T	AC-103-204-OT	
		3.0	9	AC-103-205-T	AC-103-205-OT	
 Schere spitz, einfachbeweglich <i>Scissors pointed, single action</i>		1.6	5	AC-103-612-T	AC-103-612-OT	AC-100-001
		2.3	7	AC-103-614-T	AC-103-614-OT	
 Hakenschere, einfachbeweglich <i>Hook scissors, single action</i>		2.3	7	AC-104-204-T	AC-104-204-OT	AC-100-001
		3.0	9	AC-104-205-T	AC-104-205-OT	
 Biopsiestanze, einfachbeweglich <i>Biopsy punch forceps, single action</i>		1.6	5	AC-114-202-T	AC-114-202-OT	AC-100-001



Bestell-Nr. Ordering no.	Drähte Wires	Charr. Fr.	
AF-001-021			Griff für Dormia Steinfänger 3 und 5 Charr. Handle for dormia stone extractor 3 and 5 Fr.
AF-001-001	4	3	Dormia Steinfänger, Körbchen mit Tubus , Arbeitslänge 60cm Dormia stone extractor, basket with tubus , working length 60cm
AF-001-002	4	3	Dormia Steinfänger komplett mit Griff, Arbeitslänge 60cm Dormia stone extractor complete with handle, working length 60cm
AF-001-015	4	3	Dormia Steinfänger, Körbchen mit Tubus , Arbeitslänge 90cm Dormia stone extractor, basket with tubus , working length 90cm
AF-001-016	4	3	Dormia Steinfänger komplett mit Griff, Arbeitslänge 90cm Dormia stone extractor complete with handle, working length 90cm
AF-001-003	4	5	Dormia Steinfänger, Körbchen mit Tubus , Arbeitslänge 60cm Dormia stone extractor, basket with tubus , working length 60cm
AF-001-004	4	5	Dormia Steinfänger komplett mit Griff, Arbeitslänge 60cm Dormia stone extractor complete with handle, working length 60cm
AF-001-007	5	5	Dormia Steinfänger, Körbchen mit Tubus , Arbeitslänge 60cm Dormia stone extractor, basket with tubus , working length 60cm
AF-001-008	5	5	Dormia Steinfänger komplett mit Griff, Arbeitslänge 60cm Dormia stone extractor complete with handle, working length 60cm
AF-001-011	6	5	Dormia Steinfänger, Körbchen mit Tubus , Arbeitslänge 60cm Dormia stone extractor, basket with tubus , working length 60cm
AF-001-012	6	5	Dormia Steinfänger komplett mit Griff, Arbeitslänge 60cm Dormia stone extractor complete with handle, working length 60cm
AF-001-017	4	5	Dormia Steinfänger, Körbchen mit Tubus , Arbeitslänge 90cm Dormia stone extractor, basket with tubus , working length 90cm
AF-001-019	4	5	Dormia Steinfänger komplett mit Griff, Arbeitslänge 90cm Dormia stone extractor complete with handle, working length 90cm
AF-001-025	5	5	Dormia Steinfänger, Körbchen mit Tubus , Arbeitslänge 90cm Dormia stone extractor, basket with tubus , working length 90cm
AF-001-018	5	5	Dormia Steinfänger komplett mit Griff, Arbeitslänge 90cm Dormia stone extractor complete with handle, working length 90cm



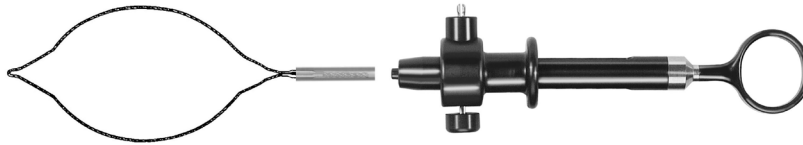









Bestell-Nr. Ordering no.	Drähte Wires	Charr. Fr.	
AF-001-024			Griff für Dormia Steinfänger 7 Charr. Handle for dormia stone extractor 7 Fr.
AF-001-005	4	7	Dormia Steinfänger, Körbchen mit Tubus , Arbeitslänge 60cm Dormia stone extractor, basket with tubus , working length 60cm
AF-001-006	4	7	Dormia Steinfänger komplett mit Griff, Arbeitslänge 60cm Dormia stone extractor complete with handle, working length 60cm
AF-001-009	5	7	Dormia Steinfänger, Körbchen mit Tubus , Arbeitslänge 60cm Dormia stone extractor, basket with tubus , working length 60cm
AF-001-010	5	7	Dormia Steinfänger komplett mit Griff, Arbeitslänge 60cm Dormia stone extractor complete with handle, working length 60cm
AF-001-013	6	7	Dormia Steinfänger, Körbchen mit Tubus , Arbeitslänge 60cm Dormia stone extractor, basket with tubus , working length 60cm
AF-001-014	6	7	Dormia Steinfänger komplett mit Griff, Arbeitslänge 60cm Dormia stone extractor complete with handle, working length 60cm



Bestell-Nr. Ordering no.	Charr. Fr.	
AF-002-002	5	Diathermie Schlinge komplett mit Griff, Arbeitslänge 60cm Diathermy loop complete with handle, working length 60cm
AF-002-001	5	Diathermie Schlinge, Schlinge mit Tubus , Arbeitslänge 60cm Diathermy loop, loop with tubus , working length 60cm
AF-002-004	7	Diathermie Schlinge komplett mit Griff, Arbeitslänge 60cm Diathermy loop complete with handle, working length 60cm
AF-002-003	7	Diathermie Schlinge, Schlinge mit Tubus , Arbeitslänge 60cm Diathermy loop, loop with tubus , working length 60cm
AF-002-010		Griff mit HF-Anschluss für Diathermie Schlingen Handle with HF connector for diathermy loops



	Bestell-Nr. Ordering no.	Länge Length	Bestell-Nr. Ordering no.	Länge Length	Charr. Fr.	
	AD-003-003	530mm	AD-003-013	650mm	5	Schlingen-Elektrode flexibel, monop. Loop electrode flexible, monopolar
	AD-003-005	530mm	AD-003-015	650mm	7	
	AD-003-007	530mm	AD-003-017	650mm	9	
	AD-003-008	530mm	AD-003-018	650mm	10	Nadel-Elektrode flexibel, monopolar Needle electrode flexible, monopolar
	AD-002-001	530mm	AD-002-011	650mm	3	
	AD-002-002	530mm	AD-002-012	650mm	4	
	AD-002-003	530mm	AD-002-013	650mm	5	Knopf-Elektrode flexibel, monopolar Button electrode flexible, monopolar
	AD-002-005	530mm	AD-002-015	650mm	7	
	AD-001-001	530mm	AD-001-011	650mm	3	
	AD-001-002	530mm	AD-001-012	650mm	4	
	AD-001-003	530mm	AD-001-013	650mm	5	
	AD-001-004	530mm	AD-001-014	650mm	6	
	AD-001-005	530mm	AD-001-015	650mm	7	
	AD-001-006	530mm	AD-001-016	650mm	8	
AD-001-007	530mm	AD-001-017	650mm	9		
	AD-001-008	530mm	AD-001-018	650mm	10	

Anschluss Instrumentenseite <i>Connection instrument side</i>		Anschluss Geräteseite <i>Connection unit side</i>	
 2mm 		AD-010-001 / AD-010-006 	
		AD-010-002 / AD-010-007 	
		AD-010-003 / AD-010-008 	
		AD-010-004 / AD-010-005 	
		AD-010-024 	
 2mm 	AD-010-021	AD-010-021 AD-010-022 AD-010-023 	
	AD-010-022		
 3mm 	AD-010-023		
Alle Kabel (außer AD-010-023) passen zu den flexiblen Elektroden AD-001-001 bis AD-003-018 All cables (except AD-010-023) fit with the flexible electrodes AD-001-001 to AD-003-018			

Bestell-Nr. Ordering no.	Länge Length	
AD-010-001 AD-010-006	3m 5m	Monopolares Anschlusskabel für Berchtold, Martin, Aesculap , Ø 4mm <i>Monopolar connecting cable for Berchtold, Martin, Aesculap, Ø 4mm</i>
AD-010-002 AD-010-007	3m 5m	Monopolares Anschlusskabel für Erbe, ACC/ICC, Storz , Ø 5mm <i>Monopolar connecting cable for Erbe, ACC/ICC, Storz, Ø 5mm</i>
AD-010-003 AD-010-008	3m 5m	Monopolares Anschlusskabel für Valleylab/Comned , Ø 8mm <i>Monopolar connecting cable for Valleylab/Comned, Ø 8mm</i>
AD-010-004 AD-010-005	3m 5m	Monopolares Anschlusskabel für Geräte mit 4mm Bananenstecker <i>Monopolar connecting cable for units with 4mm banana plug</i>
AD-010-024	4.5m	Monopolares Anschlusskabel für STEMA MASTER Geräte <i>Monopolar connecting cable for STEMA MASTER units</i>
AD-010-021	4.5m	Monopolares Anschlusskabel für STEMA MASTER Geräte mit SDS-Erkennung für STEMA , Ø 2mm <i>Monopolar connecting cable for STEMA MASTER units with SDS identification for STEMA, Ø 2mm</i>
AD-010-022	4.5m	Monopolares Anschlusskabel für STEMA MASTER Geräte mit SDS-Erkennung für STORZ , 90° Anschluss <i>Monopolar connecting cable for STEMA MASTER units with SDS identification for STORZ, 90° connection</i>
AD-010-023	4.5m	Monopolares Anschlusskabel für STEMA MASTER Geräte mit SDS-Erkennung für Olympus , Ø 3mm <i>Monopolar connecting cable for STEMA MASTER units with SDS identification for Olympus, Ø 3mm</i>

STEMA **High Definition**

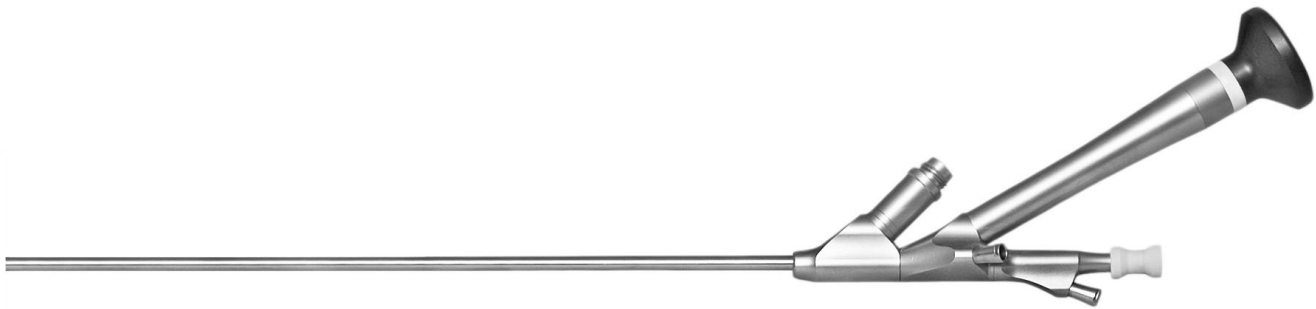

Bestell-Nr.
Ordering no.

AA-007-060

Mini HD Kompakt-Zystoskop mit 30° abgewinkeltem Okular, Schaft 9-12 Charr., Blickwinkel 0°,
Arbeitslänge 220mm, Instrumentenkanal 5 Charr., 3 Luer-Lock Anschlüsse, 40.000 Pixel
*Mini HD compact cystoscope with 30° angled ocular, sheath 9-12 Fr., viewing angle 0°,
working length 220mm, instrument channel 5 Fr., 3 luerlock connections, 40.000 pixel*

AA-007-061

Mini HD Kompakt-Zystoskop mit 30° abgewinkeltem Okular, Schaft 7.5-9 Charr., Blickwinkel 0°,
Arbeitslänge 220mm, Instrumentenkanal 1 x 4 Charr. oder 2 x 2.4 Charr., 4 Luer-Lock Anschlüsse, 17.000 Pixel
*Mini HD compact cystoscope with 30° angled ocular, sheath 7.5-9 Fr., viewing angle 0°,
working length 220mm, instrument channel 1 x 4 Fr. or 2 x 2.4 Fr., 4 luerlock connections, 17.000 pixel*

AA-007-062

Mini HD Kompakt-Zystoskop mit 30° abgewinkeltem Okular, Schaft 6.5-8.1 Charr., Blickwinkel 0°,
Arbeitslänge 220mm, Instrumentenkanal 1 x 3 Charr., 4 Luer-Lock Anschlüsse, 17.000 Pixel
*Mini HD compact cystoscope with 30° angled ocular, sheath 6.5-8.1 Fr., viewing angle 0°,
working length 220mm, instrument channel 1 x 3 Fr., 4 luerlock connections, 17.000 pixel*

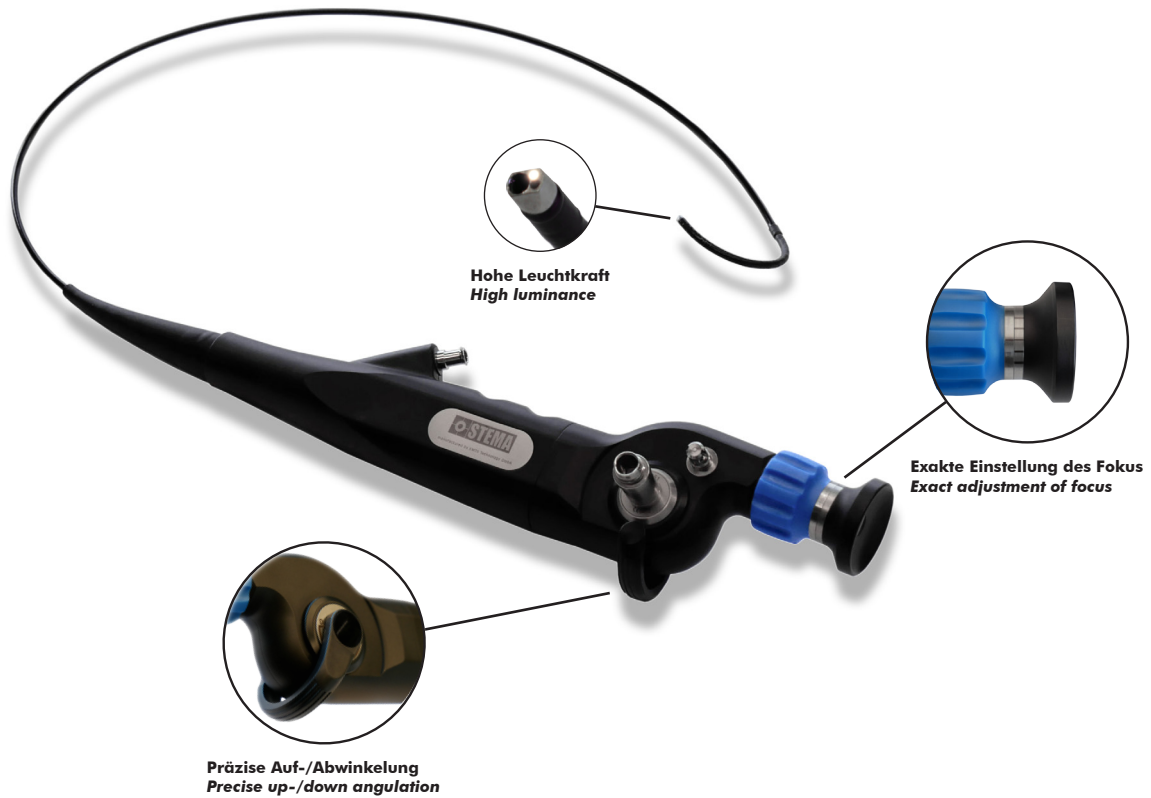

Bestell-Nr.
Ordering no.

AA-008-002

Flexibles Zystoskop FLEX I
Flexible cystoscope FLEX I

Einführschlauch / Insertion tube Ø 5.5mm / Ø 5.5mm
 Arbeitskanal / Working channel Ø 2.3mm / Ø 2.3mm
 Nutzlänge / Working length 380mm / 380mm
 Blickwinkel / Field of view 100° / 100°
 Abwinkelung auf-ab / Angulation up-down 210°-120° / 210°-120°
 Zubehör / Accessories Absaugventil, Dichtigkeitstester / Suction valve, leak tester

Im Lieferumfang enthalten
Deliver contains

Flexibles Zystoskop FLEX I, Absaugventil, Dichtigkeitstester
Flexible cystoscope FLEX I, suction valve, leak tester





Absaugventil (im Lieferumfang enthalten)
Suction valve (included in scope of delivery)



Dichtigkeitstester (im Lieferumfang enthalten)
Leak tester (included in scope of delivery)

	Bestell-Nr. Ordering no.	
	AA-008-100	Hahnbrücke mit Luer-Lock und 2 Hähnen für AA-008-002 <i>Bridge with Luer-Lock and 2 stop cocks for AA-008-002</i>
	AA-008-102	Koffer grau für STEMA flexible Optiken <i>Suitcase grey for STEMA flexible scopes</i>
	AA-008-103	Dichtigkeitstester <i>Leak tester</i>
	AA-008-104	Einweg Luer-Lock Adapter, 25 St./Box <i>Single use Luer-Lock adapter, 25 pcs./box</i>
	AA-008-105	Absaugventil <i>Suction valve</i>

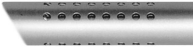





	Bestell-Nr. Ordering no.	Farbmarkierung Colour code	
	AH-001-202	Gelb Yellow	Außenschäft 26 Charr. mit Lochperforation <i>Outer sheath 26 Fr. with perforation</i>
	AH-001-212	Schwarz Black	Außenschäft 28.5 Charr. mit Lochperforation <i>Outer sheath 28.5 Fr. with perforation</i>
	AH-001-204	Gelb Yellow	Außenschäft 26 Charr. mit oben/unten Perforation <i>Outer sheath 26 Fr. with upper/lower perforation</i>
	AH-001-203	Gelb Yellow	Außenschäft 26 Charr. mit rundum gefensterter Perforation <i>Outer sheath 26 Fr. with surrounding fenestrated perforation</i>
	AH-001-205	Gelb Yellow	Außenschäft 26 Charr. mit Perforation (oben gefenestert) <i>Outer sheath 26 Fr. with perforation (upper fenestrated)</i>



Bestell-Nr. Ordering no.	Farbmarkierung Colour code	
AH-001-201	Gelb Yellow	Innenschäft 26 Charr. mit Keramikisolation <i>Inner sheath 26 Fr. with ceramic isolation</i>
AH-001-211	Schwarz Black	Innenschäft 28.5 Charr. mit Keramikisolation <i>Inner sheath 28.5 Fr. with ceramic isolation</i>



	Bestell-Nr. Ordering no.	Farbmarkierung Colour code	
	AH-001-302	Gelb Yellow	Außenschäft 26 Charr. mit Lochperforation, drehbar Outer sheath 26 Fr. with perforation, rotatable
	AH-001-312	Schwarz Black	Außenschäft 28.5 Charr. mit Lochperforation, drehbar Outer sheath 28.5 Fr. with perforation, rotatable
	AH-001-304	Gelb Yellow	Außenschäft 26 Charr. mit oben/unten Perforation, drehbar Outer sheath 26 Fr. with upper/lower perforation, rotatable
	AH-001-306	Gelb Yellow	Außenschäft 26 Charr. mit oben Perforation, drehbar Outer sheath 26 Fr. with upper perforation, rotatable
	AH-001-303	Gelb Yellow	Außenschäft 26 Charr. mit rundum gefensterter Perforation, drehbar Outer sheath 26 Fr. with surrounding fenestrated perforation, rotatable
	AH-001-305	Gelb Yellow	Außenschäft 26 Charr. mit Perforation (oben gefenstert), drehbar Outer sheath 26 Fr. with perforation (upper fenestrated), rotatable



Bestell-Nr. Ordering no.	Farbmarkierung Colour code	
AH-001-301	Gelb Yellow	Innenschäft 26 Charr. mit Keramikisolation, drehbar Inner sheath 26 Fr. with ceramic isolation, rotatable
AH-001-311	Schwarz Black	Innenschäft 28.5 Charr. mit Keramikisolation, drehbar Inner sheath 28.5 Fr. with ceramic isolation, rotatable



Bestell-Nr. Ordering no.	Farbmarkierung Colour code	
AH-001-308	Gelb Yellow	Innenschäft 26 Charr. ohne Keramikisolation, mit Lasersondenkanal bis zu 7 Charr., für Benutzung mit AH-001-301 Inner sheath 26 Fr. without ceramic isolation, with laser channel up to 7 Fr., for use with AH-001-301



	Bestell-Nr. Ordering no.	Farbmarkierung Colour code	
	AH-001-001	Gelb Yellow	Standard Resektoskopschaft 24 Charr. mit 1 <u>starr</u> en Hahn Standard resectoscope sheath 24 Fr. with 1 <u>fixed</u> stopcock
	AH-001-002	Schwarz Black	Standard Resektoskopschaft 27 Charr. mit 1 <u>starr</u> en Hahn Standard resectoscope sheath 27 Fr. with 1 <u>fixed</u> stopcock



	Bestell-Nr. Ordering no.	Farbmarkierung Colour code	
	AH-001-101	Gelb Yellow	Standard Resektoskopschaft 24 Charr. mit <u>Zentralhahn</u> Standard resectoscope sheath 24 Fr. with <u>central valve</u>
	AH-001-102	Schwarz Black	Standard Resektoskopschaft 27 Charr. mit <u>Zentralhahn</u> Standard resectoscope sheath 27 Fr. with <u>central valve</u>



Bestell-Nr. Ordering no.	Farbmarkierung Colour code	Für Außenschäft For outer sheath	
AH-001-011	Gelb Yellow	26 Charr. 26 Fr.	Standardobturator für Resektoskopschäfte 24 Charr. Standardobturator for resectosope sheaths 24 Fr.
AH-001-012	Schwarz Black	28.5 Charr. 28.5 Fr.	Standardobturator für Resektoskopschäfte 27 Charr. Standardobturator for resectosope sheaths 27 Fr.



Bestell-Nr. Ordering no.	Farbmarkierung Colour code	Für Außenschäft For outer sheath	
AH-001-015	Gelb Yellow	26 Charr. 26 Fr.	Beweglicher Obturator für Resektoskopschäfte 24 Charr. Deflecting obturator for resectosope sheaths 24 Fr.
AH-001-016	Schwarz Black	28.5 Charr. 28.5 Fr.	Beweglicher Obturator für Resektoskopschäfte 27 Charr. Deflecting obturator for resectosope sheaths 27 Fr.



Bestell-Nr. Ordering no.	Farbmarkierung Colour code	Für Außenschäft For outer sheath	
AH-001-013	Gelb Yellow	26 Charr. 26 Fr.	Sichtobturator für Resektoskopschäfte 24 Charr. Viewing obturator for resectosope sheaths 24 Fr.



Bestell-Nr. Ordering no.	Farbmarkierung Colour code	Für Außenschäft For outer sheath	
AH-001-017	Gelb Yellow	26 Charr. 26 Fr.	Sichtobturator für Resektoskopschäfte 24 Ch. mit 5 Ch. Instrumentenkanal Viewing obturator for resectosope sheaths 24 Fr. with 5 fr. instrument channel
AH-001-018	Schwarz Black	28.5 Charr. 28.5 Fr.	Sichtobturator für Resektoskopschäfte 27 Ch. mit 5 Ch. Instrumentenkanal Viewing obturator for resectosope sheaths 27 Fr. with 5 fr. instrument channel



Bestell-Nr.
Ordering no.

AG-001-001

Arbeitselement für Resektoskope, **passiv** schneidend, Griff geschlossen, Schnitt durch Federdruck
Working element used for resectoscopes, **passive** cutting, handle closed, cutting spring assisted

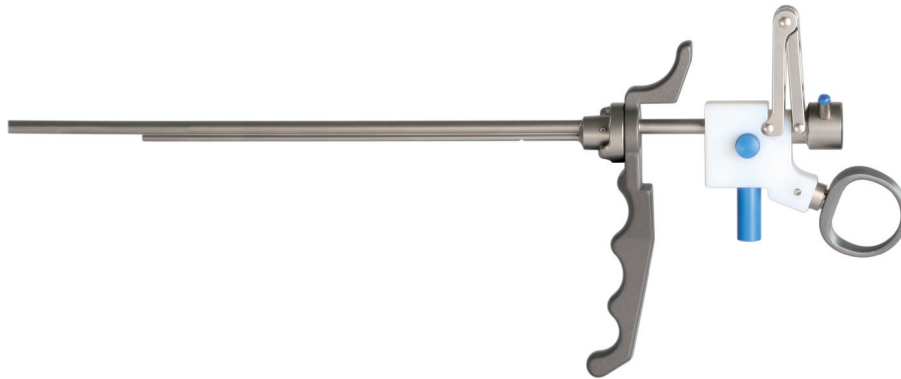

Bestell-Nr.
Ordering no.

AG-001-002

Arbeitselement für Resektoskope, **passiv** schneidend, Griff offen, Schnitt durch Federdruck
Working element used for resectoscopes, **passive** cutting, handle open, cutting spring assisted



Bestell-Nr.
Ordering no.

AG-001-003

Arbeitselement für Resektoskope, **aktiv** schneidend, Griff geschlossen, Schnitt gegen Federdruck
Working element used for resectoscopes, **active** cutting, handle closed, cutting against spring assistance

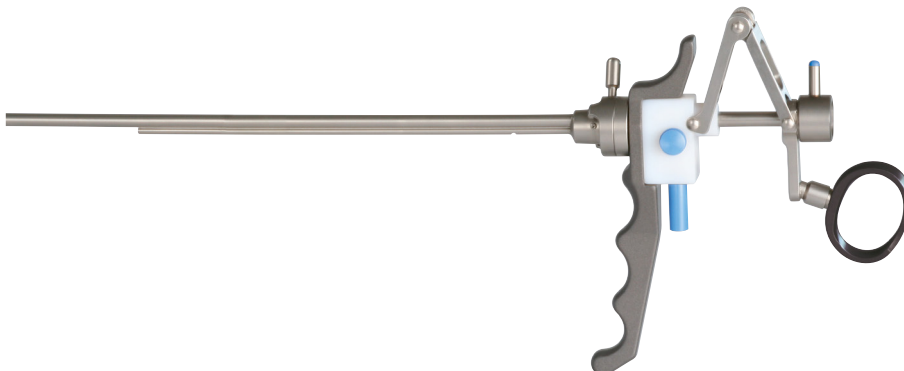

Bestell-Nr.
Ordering no.

AG-001-004

Arbeitselement für Resektoskope, **aktiv** schneidend, Griff offen, Schnitt gegen Federdruck
Working element used for resectoscopes, **active** cutting, handle open, cutting against spring assistance



Bestell-Nr.
Ordering no.

AG-001-007

Arbeitselement für Resektoskope, titan, **passiv** schneidend, Griff geschlossen, Schnitt durch Federdruck
Working element used for resectoscopes, titanium, **passive** cutting, handle closed, cutting spring assisted

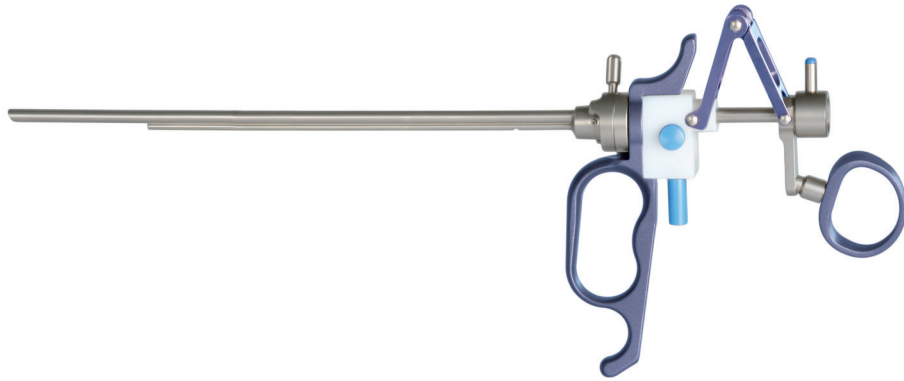

Bestell-Nr.
Ordering no.

AG-001-008

Arbeitselement für Resektoskope, titan, **aktiv** schneidend, Griff geschlossen, Schnitt gegen Federdruck
Working element used for resectoscopes, titanium, **active** cutting, handle closed, cutting against spring assistance



Bestell-Nr.
Ordering no.

AG-002-007	Arbeitselement für Laser-Resektoskope, passiv schneidend, Griff geschlossen, 19/22 Charr. mit Kanal für Sonde 0.8mm <i>Working element used for resectoscopes, titanium, passive cutting, handle closed, 19/22 Fr. with probe channel 0.8mm</i>
AG-002-008	Arbeitselement für Laser-Resektoskope, passiv schneidend, Griff geschlossen, 19/22 Charr. mit Kanal für Sonde 1.2mm <i>Working element used for resectoscopes, titanium, passive cutting, handle closed, 19/22 Fr. with probe channel 1.2mm</i>
AG-001-006	Arbeitselement für Laser-Resektoskope, passiv schneidend, Griff geschlossen, 24/26 Charr. mit Kanal für Sonde 0.8mm <i>Working element used for resectoscopes, titanium, passive cutting, handle closed, 24/26 Fr. with probe channel 0.8mm</i>
AG-001-009	Arbeitselement für Laser-Resektoskope, passiv schneidend, Griff geschlossen, 24/26 Charr. mit Kanal für Sonde 1.2mm <i>Working element used for resectoscopes, titanium, passive cutting, handle closed, 24/26 Fr. with probe channel 1.2mm</i>

Bestell-Nr.
Ordering no.

AG-100-006	Aufsatz zur Lasersondenaufnahme <i>Adaptor used for laser probes</i>
-------------------	---

Bestell-Nr.
Ordering no.

AG-100-007	TUOHY-Borst Adapter <i>TUOHY-Borst adaptor</i>
-------------------	---















	Bestell-Nr. Ordering no.	Charr. Fr.	
	AE-001-001	24 (gelb) 24 (yellow)	Schlingenelektrode 30° abgewinkelt Cutting loop electrode 30° angled
	AE-002-001	27 (braun) 27 (brown)	Schlingenelektrode 30° abgewinkelt Cutting loop electrode 30° angled
	AE-001-002	24 (gelb) 24 (yellow)	Schlingenelektrode abgewinkelt Cutting loop electrode angled
	AE-002-002	27 (braun) 27 (brown)	Schlingenelektrode abgewinkelt Cutting loop electrode angled
	AE-001-003	24 (gelb) 24 (yellow)	Schlingenelektrode gerade Cutting loop electrode straight
	AE-002-003	27 (braun) 27 (brown)	Schlingenelektrode gerade Cutting loop electrode straight
	AE-001-004	24 (gelb) 24 (yellow)	Kugelelektrode Ø 3mm Rollerball electrode Ø 3mm
	AE-001-005	24 (gelb) 24 (yellow)	Kugelelektrode Ø 5mm Rollerball electrode Ø 5mm
	AE-001-009	24 (gelb) 24 (yellow)	Kegelelektrode Conical electrode
	AE-001-010	24 (gelb) 24 (yellow)	Rollenelektrode Ø 3mm Roller electrode Ø 3mm
	AE-001-011	24 (gelb) 24 (yellow)	Rollenelektrode Ø 5mm Roller electrode Ø 5mm
	AE-001-012	24 (gelb) 24 (yellow)	Spikeelektrode Ø 3mm Spike electrode Ø 3mm
	AE-001-013	24 (gelb) 24 (yellow)	Spikeelektrode Ø 5mm Spike electrode Ø 5mm
	AE-001-014	24 (gelb) 24 (yellow)	Vaporisationelektrode Ø 3mm Vaporization electrode Ø 3mm
	AE-001-015	24 (gelb) 24 (yellow)	Vaporisationelektrode Ø 5mm Vaporization electrode Ø 5mm
	AE-001-016	24 (gelb) 24 (yellow)	Messerelektrode Knife electrode
	AE-001-006	24 (gelb) 24 (yellow)	Bandelektrode abgewinkelt Band electrode angled
	AE-002-006	27 (braun) 27 (brown)	Bandelektrode abgewinkelt Band electrode angled
	AE-001-007	24 (gelb) 24 (yellow)	Bandelektrode 30° abgewinkelt Band electrode 30° angled
	AE-002-007	27 (braun) 27 (brown)	Bandelektrode 30° abgewinkelt Band electrode 30° angled
	AE-001-008	24 (gelb) 24 (yellow)	Band Vaporisationelektrode abgewinkelt Band vaporization electrode angled
	AE-001-017	24 (gelb) 24 (yellow)	Kürette scharf, rund (nicht für den Gebrauch mit HF!) Curette sharp, round, (not for use with HF!)



**Bestell-Nr.
Ordering no.**

AJ-010-006

Schutzhülse aus Stahl zur Sterilisation und Aufbewahrung von Elektroden und Strikturmessern
Protection sleeve made of steel for sterilization and storage of electrodes and cold knives

Anschluss Instrumentenseite Connection instrument side		Anschluss Geräteseite Connection unit side	
 		AD-010-001 / AD-010-006 	
		AD-010-002 / AD-010-007 	
		AD-010-003 / AD-010-008 	
		AD-010-004 / AD-010-005 	
		AD-010-024 	
	 AD-010-021	AD-010-021 AD-010-022 AD-010-023 	
	 AD-010-022		
	 AD-010-023		
Alle Kabel (außer AD-010-023) passen zu den Arbeitselementen AG-001-001 bis AG-001-008 All cables (except AD-010-023) fit with the working elements AG-001-001 to AG-001-008			

Bestell-Nr. Ordering no.	Länge Length	
AD-010-001 AD-010-006	3m 5m	Monopolares Anschlusskabel für Berchtold, Martin, Aesculap , Ø 4mm Monopolar connecting cable for Berchtold, Martin, Aesculap , Ø 4mm
AD-010-002 AD-010-007	3m 5m	Monopolares Anschlusskabel für Erbe, ACC/ICC, Storz , Ø 5mm Monopolar connecting cable for Erbe, ACC/ICC, Storz , Ø 5mm
AD-010-003 AD-010-008	3m 5m	Monopolares Anschlusskabel für Valleylab/Comned , Ø 8mm Monopolar connecting cable for Valleylab/Comned , Ø 8mm
AD-010-004 AD-010-005	3m 5m	Monopolares Anschlusskabel für Geräte mit 4mm Bananenstecker Monopolar connecting cable for units with 4mm banana plug
AD-010-024	4.5m	Monopolares Anschlusskabel für STEMA MASTER Geräte Monopolar connecting cable for STEMA MASTER units
AD-010-021	4.5m	Monopolares Anschlusskabel für STEMA MASTER Geräte mit SDS-Erkennung für STEMA , Ø 2mm Monopolar connecting cable for STEMA MASTER units with SDS identification for STEMA , Ø 2mm
AD-010-022	4.5m	Monopolares Anschlusskabel für STEMA MASTER Geräte mit SDS-Erkennung für STORZ , 90° Anschluss Monopolar connecting cable for STEMA MASTER units with SDS identification for STORZ , 90° connection
AD-010-023	4.5m	Monopolares Anschlusskabel für STEMA MASTER Geräte mit SDS-Erkennung für Olympus , Ø 3mm Monopolar connecting cable for STEMA MASTER units with SDS identification for Olympus , Ø 3mm



Bestell-Nr.
Ordering no.

AA-001-003	Resektoskop Ø 2.7mm, Blickwinkel 30°, autoklavierbar Resectoscope Ø 2.7mm, 30° viewing angle, autoclavable
AA-003-002	Resektoskop Ø 2.9mm, Blickwinkel 30°, autoklavierbar Resectoscope Ø 2.9mm, 30° viewing angle, autoclavable
AA-001-013	HD Resektoskop Ø 2.7mm, Blickwinkel 30°, autoklavierbar HD Resectoscope Ø 2.7mm, 30° viewing angle, autoclavable
AA-003-012	HD Resektoskop Ø 2.9mm, Blickwinkel 30°, autoklavierbar HD Resectoscope Ø 2.9mm, 30° viewing angle, autoclavable



	Bestell-Nr. Ordering no.	Farbmarkierung Colour code	
	AH-002-212	Weiß White	Außenschäft 22 Charr. mit Lochperforation Outer sheath 22 Fr. with perforation



Bestell-Nr. Ordering no.	Farbmarkierung Colour code	
AH-002-201	Weiß White	Innenschäft 19 Charr. mit Keramikisolation Inner sheath 19 Fr. with ceramic isolation



Bestell-Nr. Ordering no.	Farbmarkierung Colour code	Für Außenschäft For outer sheath	
AH-002-011	Weiß White	22 Charr. 22 Fr.	Standardobturator 19 Charr. Standardobturator 19 Fr.



Bestell-Nr. Ordering no.	Farbmarkierung Colour code	Für Außenschäft For outer sheath	
AH-002-013	Weiß White	22 Charr. 22 Fr.	Sichtobturator 19 Charr. Viewing obturator 19 Fr.



Bestell-Nr.
Ordering no.

AA-001-003	Resektoskop Ø 2.7mm, Blickwinkel 30°, autoklavierbar Resectoscope Ø 2.7mm, 30° viewing angle, autoclavable
AA-003-002	Resektoskop Ø 2.9mm, Blickwinkel 30°, autoklavierbar Resectoscope Ø 2.9mm, 30° viewing angle, autoclavable
AA-001-013	HD Resektoskop Ø 2.7mm, Blickwinkel 30°, autoklavierbar HD Resectoscope Ø 2.7mm, 30° viewing angle, autoclavable
AA-003-012	HD Resektoskop Ø 2.9mm, Blickwinkel 30°, autoklavierbar HD Resectoscope Ø 2.9mm, 30° viewing angle, autoclavable



Bestell-Nr.
Ordering no. **Farbmarkierung**
Colour code



AH-002-302	Weiß White	Außenschaft 22 Charr. mit Lochperforation, drehbar Outer sheath 22 Fr. with perforation, rotatable
-------------------	---------------	---



Bestell-Nr.
Ordering no. **Farbmarkierung**
Colour code

AH-002-301	Weiß White	Innenschaft 22 Charr. mit Keramikisolation, drehbar Inner sheath 22 Fr. with ceramic isolation, rotatable
-------------------	---------------	--



Bestell-Nr.
Ordering no. **Farbmarkierung**
Colour code **Für Außenschaft**
For outer sheath

AH-002-011	Weiß White	22 Charr. 22 Fr.	Standardobturator 19 Charr. Standardobturator 19 Fr.
-------------------	---------------	---------------------	---



Bestell-Nr.
Ordering no. **Farbmarkierung**
Colour code **Für Außenschaft**
For outer sheath

AH-002-013	Weiß White	22 Charr. 22 Fr.	Sichtobturator 19 Charr. Viewing obturator 19 Fr.
-------------------	---------------	---------------------	--



Bestell-Nr.
Ordering no.

AA-001-003	Resektoskop Ø 2.7mm, Blickwinkel 30°, autoklavierbar Resectoscope Ø 2.7mm, 30° viewing angle, autoclavable
AA-003-002	Resektoskop Ø 2.9mm, Blickwinkel 30°, autoklavierbar Resectoscope Ø 2.9mm, 30° viewing angle, autoclavable
AA-001-013	HD Resektoskop Ø 2.7mm, Blickwinkel 30°, autoklavierbar HD Resectoscope Ø 2.7mm, 30° viewing angle, autoclavable
AA-003-012	HD Resektoskop Ø 2.9mm, Blickwinkel 30°, autoklavierbar HD Resectoscope Ø 2.9mm, 30° viewing angle, autoclavable



Bestell-Nr.
Ordering no. **Farbmarkierung**
Colour code



AH-002-001

Weiß
White

Standard Resektoskopschaft 19 Ch., 1 starren Hahn, ohne Obturator
Standard resectoscope sheath 19 Fr., 1 fixed stopcock, without obturator



Bestell-Nr.
Ordering no. **Farbmarkierung**
Colour code **Für Außenschaft**
For outer sheath

AH-002-011	Weiß White	22 Charr. 22 Fr.	Standardobturator 19 Charr. Standardobturator 19 Fr.
-------------------	---------------	---------------------	---



Bestell-Nr.
Ordering no. **Farbmarkierung**
Colour code **Für Außenschaft**
For outer sheath

AH-002-013	Weiß White	22 Charr. 22 Fr.	Sichtobturator 19 Charr. Viewing obturator 19 Fr.
-------------------	---------------	---------------------	--



Bestell-Nr.
Ordering no.

AG-002-001

Arbeitselement für SLIM Resektoskope, **passiv** schneidend, Griff geschlossen, Schnitt durch Federdruck
Working element used for SLIM resectoscopes, **passive** cutting, handle closed, cutting spring assisted

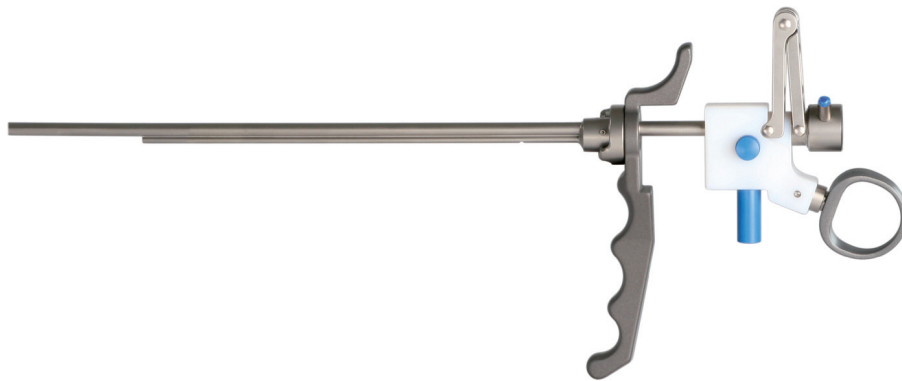

Bestell-Nr.
Ordering no.

AG-002-002

Arbeitselement für Resektoskope, **passiv** schneidend, Griff offen, Schnitt durch Federdruck
Working element used for resectoscopes, **passive** cutting, handle open, cutting spring assisted



Bestell-Nr.
Ordering no.

AG-002-003

Arbeits Element für Resektoskope, **aktiv** schneidend, Griff geschlossen, Schnitt gegen Federdruck
Working element used for resectoscopes, **active** cutting, handle closed, cutting against spring assistance

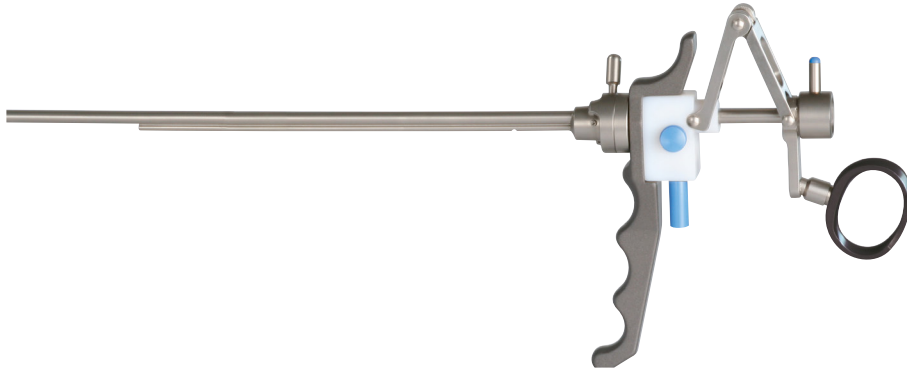







Bestell-Nr.
Ordering no.

AG-002-004

Arbeits Element für Resektoskope, **aktiv** schneidend, Griff offen, Schnitt gegen Federdruck
Working element used for resectoscopes, **active** cutting, handle open, cutting against spring assistance















	Bestell-Nr. Ordering no.	Charr. Fr.	
	AE-003-001	19 (weiß) 19 (white)	Schlingenelektrode 30° abgewinkelt Cutting loop electrode 30° angled
	AE-003-003	19 (weiß) 19 (white)	Schlingenelektrode gerade Cutting loop electrode straight
	AE-003-004	19 (weiß) 19 (white)	Kugelelektrode Ø 3mm Rollerball electrode Ø 3mm
	AE-003-010	19 (weiß) 19 (white)	Rollenelektrode Ø 3mm Roller electrode Ø 3mm
	AE-003-014	19 (weiß) 19 (white)	Vaporisationselektrode Vaporization electrode
	AE-003-016	19 (weiß) 19 (white)	Messerelektrode Knife electrode



**Bestell-Nr.
Ordering no.**

AJ-010-006

Schutzhülse aus Stahl zur Sterilisation und Aufbewahrung von Elektroden und Strikturmessern
Protection sleeve made of steel for sterilization and storage of electrodes and cold knives

Anschluss Instrumentenseite <i>Connection instrument side</i>		Anschluss Geräteseite <i>Connection unit side</i>	
		AD-010-001 / AD-010-006 	
		AD-010-002 / AD-010-007 	
		AD-010-003 / AD-010-008 	
		AD-010-004 / AD-010-005 	
		AD-010-024 	
	 AD-010-021		
	 AD-010-022		AD-010-021 AD-010-022 AD-010-023
	 AD-010-023		
Alle Kabel (außer AD-010-023) passen zu den Arbeitselementen AG-002-001 bis AG-002-004 All cables (except AD-010-023) fit with the working elements AG-002-001 to AG-002-004			

Bestell-Nr. Ordering no.	Länge Length	
AD-010-001 AD-010-006	3m 5m	Monopolares Anschlusskabel für Berchtold, Martin, Aesculap , Ø 4mm <i>Monopolar connecting cable for Berchtold, Martin, Aesculap, Ø 4mm</i>
AD-010-002 AD-010-007	3m 5m	Monopolares Anschlusskabel für Erbe, ACC/ICC, Storz , Ø 5mm <i>Monopolar connecting cable for Erbe, ACC/ICC, Storz, Ø 5mm</i>
AD-010-003 AD-010-008	3m 5m	Monopolares Anschlusskabel für Valleylab/Conmed , Ø 8mm <i>Monopolar connecting cable for Valleylab/Conmed, Ø 8mm</i>
AD-010-004 AD-010-005	3m 5m	Monopolares Anschlusskabel für Geräte mit 4mm Bananenstecker <i>Monopolar connecting cable for units with 4mm banana plug</i>
AD-010-024	4.5m	Monopolares Anschlusskabel für STEMA MASTER Geräte <i>Monopolar connecting cable for STEMA MASTER units</i>
AD-010-021	4.5m	Monopolares Anschlusskabel für STEMA MASTER Geräte mit SDS-Erkennung für STEMA , Ø 2mm <i>Monopolar connecting cable for STEMA MASTER units with SDS identification for STEMA, Ø 2mm</i>
AD-010-022	4.5m	Monopolares Anschlusskabel für STEMA MASTER Geräte mit SDS-Erkennung für STORZ , 90° Anschluss <i>Monopolar connecting cable for STEMA MASTER units with SDS identification for STORZ, 90° connection</i>
AD-010-023	4.5m	Monopolares Anschlusskabel für STEMA MASTER Geräte mit SDS-Erkennung für Olympus , Ø 3mm <i>Monopolar connecting cable for STEMA MASTER units with SDS identification for Olympus, Ø 3mm</i>



Bestell-Nr.
Ordering no.

AA-003-002 Resektoskop Ø 2.9mm, Blickwinkel 30°, autoklavierbar
 Resectoscope Ø 2.9mm, 30° viewing angle, autoclavable

AA-003-012 **HD** Resektoskop Ø 2.9mm, Blickwinkel 30°, autoklavierbar
HD Resectoscope Ø 2.9mm, 30° viewing angle, autoclavable



Bestell-Nr.
Ordering no.

Farbmarkierung
Colour code



AH-002-213

Grün
 Green

Außenschaft **18.5** Charr. mit Lochperforation
 Outer sheath **18.5** Fr. with perforation



Bestell-Nr.
Ordering no.

Farbmarkierung
Colour code

AH-002-211

Grün
 Green

Innenschaft **17.5** Charr. mit Keramikisolation, drehbar
 Inner sheath **17.5** Fr. with ceramic isolation, rotatable



Bestell-Nr.
Ordering no.

Farbmarkierung
Colour code

Für Außenschaft
For outer sheath

AH-002-015

Grün
 Green

18.5 Charr.
 18.5 Fr.



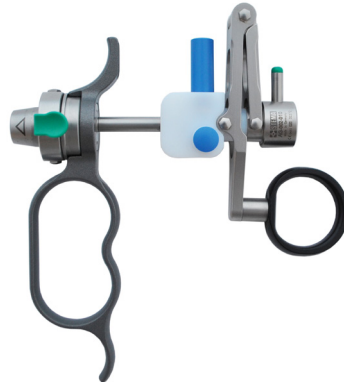

Standardobturator **17.5** Charr.
 Standardobturator **17.5** Fr.



Bestell-Nr.
Ordering no.

AG-002-010	Arbeitselement für MINI Resektoskope, passiv schneidend, Griff geschlossen, Schnitt durch Federdruck Working element used for MINI resectoscopes, passive cutting, handle closed, cutting spring assisted
AG-002-014	Arbeitselement für MINI Resektoskope, aktiv schneidend, Griff geschlossen, Schnitt durch Federdruck Working element used for MINI resectoscopes, active cutting, handle closed, cutting spring assisted



	Bestell-Nr. Ordering no.	Charr. Fr.	
	AE-003-021	17.5 (grün) 17.5 (green)	Schlingenelektrode 30° abgewinkelt Cutting loop electrode 30° angled
	AE-003-023	17.5 (grün) 17.5 (green)	Schlingenelektrode gerade Cutting loop electrode straight
	AE-003-024	17.5 (grün) 17.5 (green)	Kugelelektrode Ø 2mm Rollerball electrode Ø 2mm
	AE-003-025	17.5 (grün) 17.5 (green)	Rollenelektrode Ø 2mm Rollerball electrode Ø 2mm
	AE-003-026	17.5 (grün) 17.5 (green)	Messerelektrode Knife electrode



Bestell-Nr.
Ordering no.

AJ-010-006	Schutzhülse aus Stahl zur Sterilisation und Aufbewahrung von Elektroden und Strikturmessern Protection sleeve made of steel for sterilization and storage of electrodes and cold knives
-------------------	--



Bestell-Nr.
Ordering no.

AA-003-002 Resektoskop Ø 2.9mm, Blickwinkel 30°, autoklavierbar
 Resectoscope Ø 2.9mm, 30° viewing angle, autoclavable

AA-003-012 **HD** Resektoskop Ø 2.9mm, Blickwinkel 30°, autoklavierbar
HD Resectoscope Ø 2.9mm, 30° viewing angle, autoclavable



Bestell-Nr.
Ordering no.

Farbmarkierung
Colour code



AH-002-213

Grün
 Green

Außenschaft **18.5** Charr. mit Lochperforation
 Outer sheath **18.5** Fr. with perforation



Bestell-Nr.
Ordering no.

Farbmarkierung
Colour code

AH-002-216

Grün
 Green

Innenschaft **17.5** Charr. ohne Keramikisolation, mit Lasersondenkanal bis zu 5 Charr.,
 für Benutzung mit AH-001-213
 Inner sheath **17.5** Fr. without ceramic isolation, with laser channel up to 5 Fr.,
 for use with AH-001-213



Bestell-Nr.
Ordering no.

Farbmarkierung
Colour code

AH-002-211

Grün
 Green

Innenschaft **17.5** Charr. mit Keramikisolation, drehbar
 Inner sheath **17.5** Fr. with ceramic isolation, rotatable



Bestell-Nr.
Ordering no.

Farbmarkierung
Colour code

Für Außenschaft
For outer sheath

AH-002-015

Grün
 Green



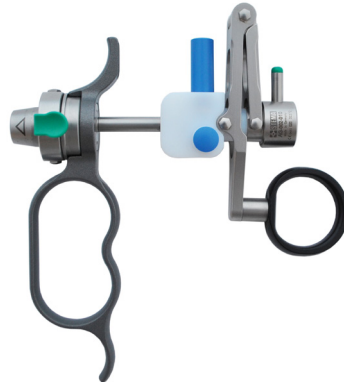

18.5 Charr.
 18.5 Fr.

Standardobturator **17.5** Charr.
 Standardobturator **17.5** Fr.



Bestell-Nr. Ordering no.	
AG-002-015	SALINE Arbeitselement für MINI Resektoskope, passiv schneidend, Griff geschlossen, Schnitt durch Federdruck SALINE Working element used for MINI resectoscopes, passive cutting, handle closed, cutting spring assisted
AG-002-013	SALINE Arbeitselement für MINI Resektoskope, aktiv schneidend, Griff geschlossen, Schnitt durch Federdruck SALINE Working element used for MINI resectoscopes, active cutting, handle closed, cutting spring assisted



	Bestell-Nr. Ordering no.	Charr. Fr.	
	AE-003-041	17.5 (grün) 17.5 (green)	Schlingenelektrode 30° abgewinkelt Cutting loop electrode 30° angled
	AE-003-043	17.5 (grün) 17.5 (green)	Schlingenelektrode gerade Cutting loop electrode straight
	AE-003-044	17.5 (grün) 17.5 (green)	Kugelelektrode Ø 2mm Rollerball electrode Ø 2mm
	AE-003-045	17.5 (grün) 17.5 (green)	Rollenelektrode Ø 2mm Rollerball electrode Ø 2mm
	AE-003-046	17.5 (grün) 17.5 (green)	Messerelektrode Knife electrode



Bestell-Nr. Ordering no.	
AJ-010-006	Schutzhülse aus Stahl zur Sterilisation und Aufbewahrung von Elektroden und Strikturmessern Protection sleeve made of steel for sterilization and storage of electrodes and cold knives



Bestell-Nr.
Ordering no.

AA-003-002 Resektoskop Ø 2.9mm, Blickwinkel 30°, autoklavierbar
 Resectoscope Ø 2.9mm, 30° viewing angle, autoclavable

AA-003-012 **HD** Resektoskop Ø 2.9mm, Blickwinkel 30°, autoklavierbar
HD Resectoscope Ø 2.9mm, 30° viewing angle, autoclavable



Bestell-Nr.
Ordering no.

Farbmarkierung
Colour code



AH-002-302

Weiß
 White

Außenschaft **22** Charr. mit Lochperforation, drehbar
 Outer sheath **22** Fr. with perforation, rotatable



Bestell-Nr.
Ordering no.

Farbmarkierung
Colour code

AH-002-301

Weiß
 White

Innenschaft **22** Charr. mit Keramikisolation, drehbar
 Inner sheath **22** Fr. with ceramic isolation, rotatable



Bestell-Nr.
Ordering no.

Farbmarkierung
Colour code

Für Außenschaft
For outer sheath

AH-002-011

Weiß
 White

22 Charr.
 22 Fr.

Standardobturator **19** Charr.
 Standardobturator **19** Fr.



Bestell-Nr.
Ordering no.

Farbmarkierung
Colour code

Für Außenschaft
For outer sheath

AH-002-013

Weiß
 White

22 Charr.
 22 Fr.

Sichtobturator **19** Charr.
 Viewing obturator **19** Fr.

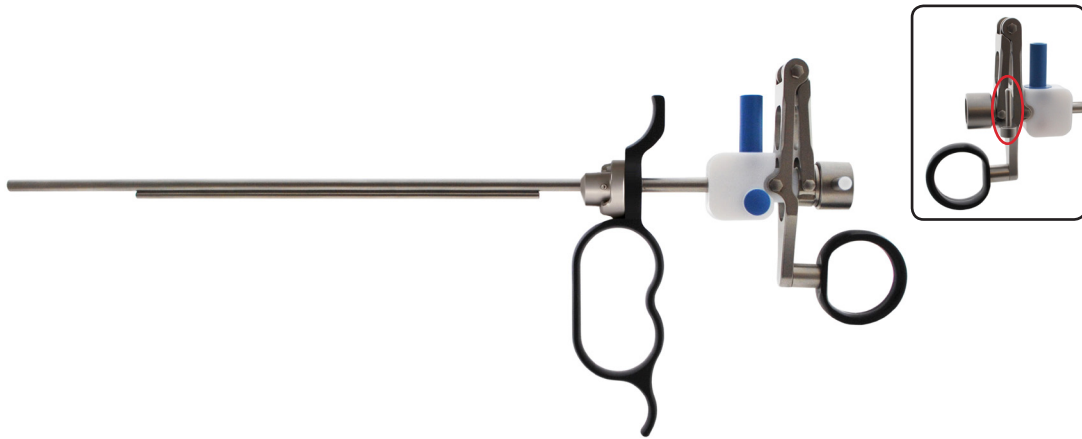

Bestell-Nr.
Ordering no.

AG-002-011

SALINE Arbeitselement für Resektoskope, **19 Ch.** System, **passiv** schneidend, Griff geschlossen, Schnitt durch Federdruck
SALINE Working element used for resectoscopes, **19 Fr.** system, **passive** cutting, handle closed, cutting spring assisted

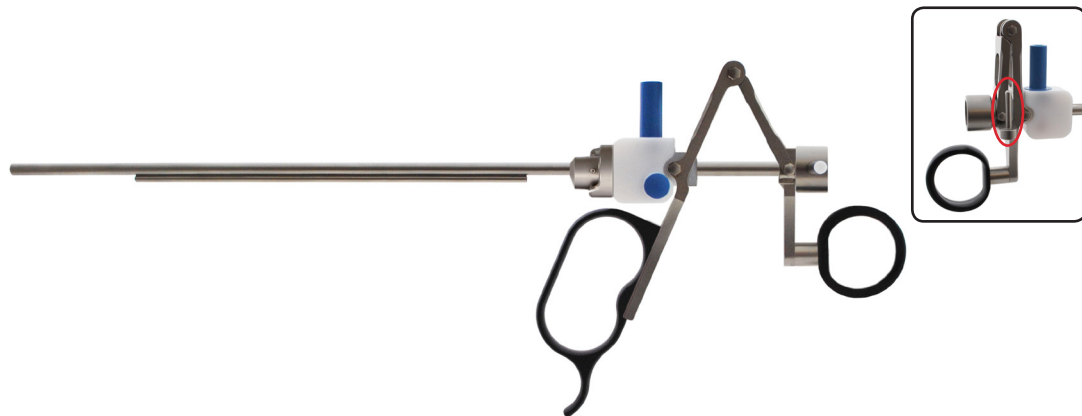





Bestell-Nr.
Ordering no.

AG-002-012

SALINE Arbeitselement für Resektoskope, **19 Ch.** System, **aktiv** schneidend, Griff geschlossen, Schnitt durch Federdruck
SALINE Working element used for resectoscopes, **19 Fr.** system, **active** cutting, handle closed, cutting spring assisted

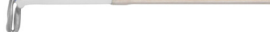

	Bestell-Nr. Ordering no.	Charr. Fr.	
	AE-003-031	19 (weiß-blau) 19 (white-blue)	Schlingenelektrode 30° abgewinkelt Cutting loop electrode 30° angled
	AE-003-032	19 (weiß-blau) 19 (white-blue)	Schlingenelektrode 90° abgewinkelt Cutting loop electrode 90° angled
	AE-003-033	19 (weiß-blau) 19 (white-blue)	Schlingenelektrode gerade Cutting loop electrode straight
	AE-003-034	19 (weiß-blau) 19 (white-blue)	Kugелеlektrode Ø 3mm Rollerball electrode Ø 3mm
	AE-003-040	19 (weiß-blau) 19 (white-blue)	Rollenelektrode Ø 3mm Roller electrode Ø 3mm
	AE-003-036	19 (weiß-blau) 19 (white-blue)	Messerelektrode Knife electrode



**Bestell-Nr.
Ordering no.**

AA-002-003	Resektoskop Ø 4.0mm, Blickwinkel 30° autoklavierbar <i>Resectoscope Ø 4.0mm, 30° viewing angle, autoclavable</i>
AA-002-013	HD Resektoskop Ø 4.0mm, Blickwinkel 30°, autoklavierbar HD Resectoscope Ø 4.0mm, 30° viewing angle, autoclavable
AA-002-023	Ultra HD Resektoskop Ø 4.0mm, Blickwinkel 30°, autoklavierbar Ultra HD Resectoscope Ø 4.0mm, 30° viewing angle, autoclavable



**Bestell-Nr.
Ordering no.** **Farbmarkierung
Colour code**



AH-001-302	Gelb Yellow	Außenschäft 26 Charr. mit Lochperforation, drehbar <i>Outer sheath 26 Fr. with perforation, rotatable</i>
-------------------	----------------	---



**Bestell-Nr.
Ordering no.** **Farbmarkierung
Colour code**

AH-001-301	Gelb Yellow	Innenschäft 26 Charr. mit Keramikisolation, drehbar <i>Inner sheath 26 Fr. with ceramic isolation, rotatable</i>
-------------------	----------------	--



**Bestell-Nr.
Ordering no.** **Farbmarkierung
Colour code** **Für Außenschäft
For outer sheath**

AH-001-011	Gelb Yellow	26 Charr. 26 Fr.	Standardobturator für Resektoskopschäfte 24 Charr. <i>Standardobturator for resectosope sheaths 24 Fr.</i>
-------------------	----------------	---------------------	--

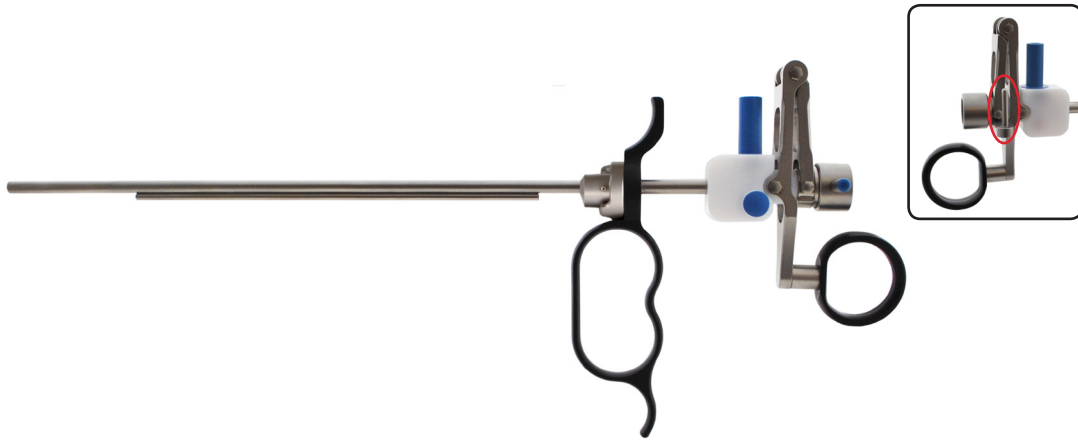

Bestell-Nr.
Ordering no.

AG-001-011

SALINE Arbeitselement für Resektoskope, **passiv** schneidend, Griff geschlossen, Schnitt durch Federdruck
SALINE working element used for resectoscopes, **passive** cutting, handle closed, cutting spring assistance

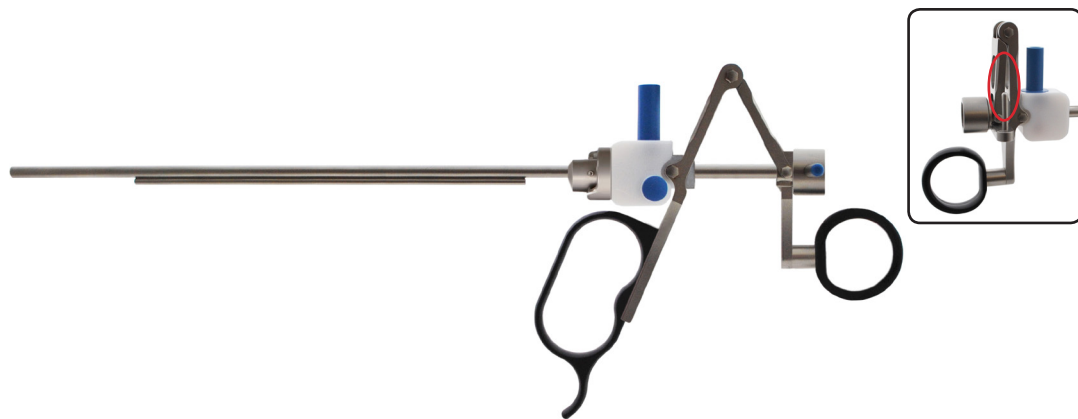















Bestell-Nr.
Ordering no.

AG-001-012

SALINE Arbeitselement für Resektoskope, **aktiv** schneidend, Griff geschlossen, Schnitt gegen Federdruck
SALINE working element used for resectoscopes, **active** cutting, handle closed, cutting against spring assistance







	Bestell-Nr. Ordering no.	Charr. Fr.	
	AE-001-030	24 (blau/gelb) 24 (blue/yellow)	Schlingenelektrode 30° abgewinkelt, starker Schnitt Cutting loop electrode 30° angled, strong cut
	AE-001-031	24 (blau/gelb) 24 (blue/yellow)	Schlingenelektrode 30° abgewinkelt Cutting loop electrode 30° angled
	AE-001-032	24 (blau/gelb) 24 (blue/yellow)	Messerelektrode Knife electrode
	AE-001-033	24 (blau/gelb) 24 (blue/yellow)	Schlingenelektrode 90° abgewinkelt, für 0° Optiken Cutting loop electrode 90° angled, for 0° scopes
	AE-001-034	24 (blau/gelb) 24 (blue/yellow)	Kugelelektrode Ø 3mm Rollerball electrode Ø 3mm
	AE-001-035	24 (blau/gelb) 24 (blue/yellow)	Kugelelektrode Ø 5mm Rollerball electrode Ø 5mm
	AE-001-036	24 (blau/gelb) 24 (blue/yellow)	Schlingenelektrode gerade Cutting loop electrode straight
	AE-001-037	24 (blau/gelb) 24 (blue/yellow)	Vaporisations Rollenelektrode glatt Ø 3mm Vaporisation rollerball electrode smooth Ø 3mm
	AE-001-043	24 (blau/gelb) 24 (blue/yellow)	Vaporisations Rollenelektrode glatt Ø 5mm Vaporisation rollerball electrode smooth Ø 5mm
	AE-001-038	24 (blau/gelb) 24 (blue/yellow)	Vaporisations Spikerollenelektrode Ø 3mm Vaporisation spike rollerball electrode Ø 3mm
	AE-001-039	24 (blau/gelb) 24 (blue/yellow)	Kegelelektrode Conical electrode
	AE-001-040	24 (blau/gelb) 24 (blue/yellow)	Rollenelektrode Ø 3mm Rollerball electrode smooth Ø 3mm
	AE-001-042	24 (blau/gelb) 24 (blue/yellow)	Rollenelektrode glatt Ø 5mm Rollerball electrode smooth Ø 5mm
	AE-001-041	24 (blau/gelb) 24 (blue/yellow)	Bandelektrode 30° abgewinkelt Band electrode 30° angled
	AE-001-044	24 (blau/gelb) 24 (blue/yellow)	Kegelelektrode „Mushroom“ Conical electrode „Mushroom“
	AE-001-045	24 (blau/gelb) 24 (blue/yellow)	Kegelelektrode „Mushroom“, konvex Conical electrode „Mushroom“, convex
	AE-001-046	24 (blau/gelb) 24 (blue/yellow)	Kegelelektrode „Mushroom“, konkav Conical electrode „Mushroom“, concave
	AE-001-047	24 (blau/gelb) 24 (blue/yellow)	Kegelelektrode „Mushroom“, geriffelt Conical electrode „Mushroom“, grooved



Bestell-Nr.
Ordering no.

AJ-010-006

Schutzhülse aus Stahl zur Sterilisation und Aufbewahrung von Elektroden und Strikturmessern
Protection sleeve made of steel for sterilization and storage of electrodes and cold knives

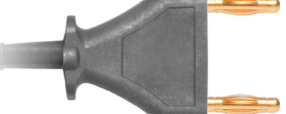
Anschluss Instrumentenseite <i>Connection instrument side</i>	Anschluss Geräteseite <i>Connection unit side</i>
	<p>AD-010-011 </p>
	<p>AD-010-012 </p>
	<p>AD-010-013 </p>
	<p>AD-010-030 / AD-010-031 </p>
	<p>AD-010-034 </p>
<p>Alle Kabel passen zu den Arbeitselementen AG-001-011 und AG-001-012 <i>All cables fit with the working elements AG-001-011 and AG-001-012</i></p>	

Bestell-Nr. Ordering no.	Länge Length	
AD-010-011	4.5m	Bipolares Resektoskop-Anschlusskabel für Martin Maxium <i>Bipolar resectoscope connecting cable for Martin Maxium</i>
AD-010-012	4.5m	Bipolares Resektoskop-Anschlusskabel für Erbe Vio <i>Bipolar resectoscope connecting cable for Erbe Vio</i>
AD-010-013	4.5m	Bipolares Resektoskop-Anschlusskabel für Valleylab, Lamidey, EMC <i>Bipolar resectoscope connecting cable for Valleylab, Lamidey, EMC</i>
AD-010-030	4.5m	Bipolares Resektoskop-Anschlusskabel für STEMA MASTER Geräte mit SDS-Erkennung für Storz <i>Bipolar resectoscope connecting cable for STEMA MASTER units with SDS identification for Storz</i>
AD-010-031	4.5m	Bipolares Resektoskop-Anschlusskabel für STEMA MASTER Geräte mit SDS-Erkennung <i>Bipolar resectoscope connecting cable for STEMA MASTER units with SDS identification</i>
AD-010-034	4.5m	Bipolares Resektoskop-Anschlusskabel für STEMA MASTER Geräte <i>Bipolar resectoscope connecting cable for STEMA MASTER units</i>



Info: Diese Artikel sind nur auf Anfrage erhältlich.
Info: These items are only available on request.



Bestell-Nr.
Ordering no.

AB-007-001 Suprapubisches Aspirationsbesteck, komplettes Set
Suprapubic aspiration set, complete set



Bestell-Nr.
Ordering no.

AB-007-002 Trocarhülse 16 Ch. mit Druckmesskanal
Trocar sleeve 16 Fr. with pressure measuring channel

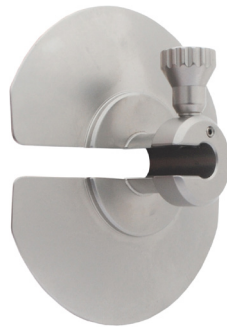

Bestell-Nr.
Ordering no.

AB-007-003 Stabilisierungsscheibe, seitlich geöffnet
Adjustable stabilisation disc, lateral opening



Bestell-Nr.
Ordering no.

AB-007-008 Führungshülse, seitlich geöffnet, zum Einlegen eines suprapubischen Ballonkatheters
Guide sleeve, lateral opening, for inserting a suprapubic catheter



Info: Diese Artikel sind nur *auf Anfrage* erhältlich.
Info: These items are only available *on request*.



Bestell-Nr.
Ordering no.

AB-007-004 Trocar mit Kanülenspitze
Trocar with cannula tip



Bestell-Nr.
Ordering no.

AB-007-005 Trocar mit Dreikantspitze
Trocar with pyramidal tip



Bestell-Nr.
Ordering no.

AB-007-006 Aspirationskanüle
Aspiration cannula



Bestell-Nr.
Ordering no.

AB-007-007 Überlaufkanüle zur Druckstabilisierung
Overflow cannula for pressure stabilisation

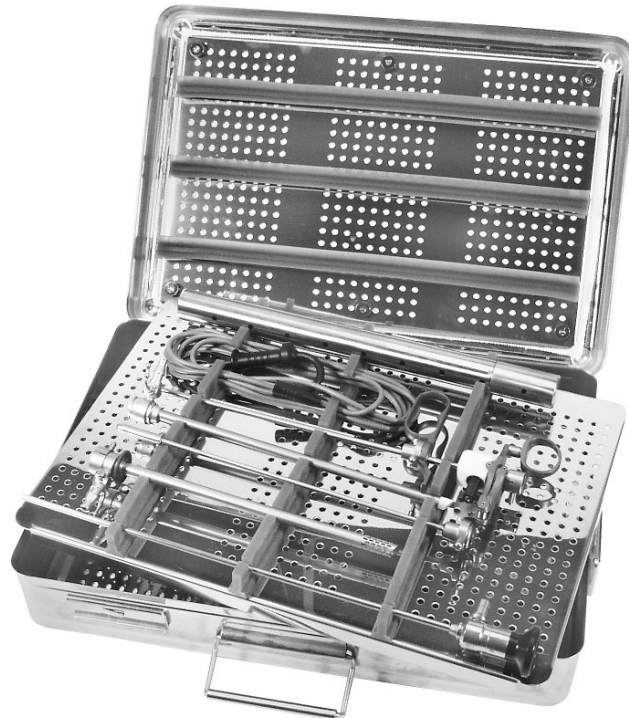

**AJ-010-020 /
AJ-010-021 /
FA-600-001**

**Bestell-Nr.
Ordering no.**

AJ-010-020	<p>Behältereinatz für Resektoskopie (ohne Instrumente, ohne Sterilisationskassette), Abmessung 370 x 255 x 45mm (L x B x H) Vorbereitet für folgende Artikel: AA-002-003, AG-001-001, AH-001-011, AH-001-302, AH-001-302, AJ-010-006, AJ-020-001 Tray insert for resectoscopy (without instruments, without sterilization box), dimension 370 x 255 x 45mm (l x w x h) Prepared for the following items: AA-002-003, AG-001-001, AH-001-011, AH-001-302, AH-001-302, AJ-010-006, AJ-020-001</p>
AJ-010-021	<p>Behältereinatz für Cystoskopie (ohne Instrumente, ohne Sterilisationskassette), Abmessung 370 x 255 x 45mm (L x B x H) Vorbereitet für folgende Artikel: AA-002-003, AB-001-002, AB-001-003, AB-001-004, AB-003-002, AB-003-003, AB-003-004, AB-003-007 Tray insert for cystoscopy (without instruments, without sterilization box), dimension 370 x 255 x 45mm (l x w x h) Prepared for the following items: AA-002-003, AB-001-002, AB-001-003, AB-001-004, AB-003-002, AB-003-003, AB-003-004, AB-003-007</p>



Bestell-Nr. Ordering no.	
AJ-002-001	Ellik Evakuator komplett mit Schaftanschluss und Verriegelung <i>Ellik evacuator complete with sheath connection and locking device</i>
AJ-002-002	Glasbehälter allein <i>Bowl only</i>
AJ-002-003	Gummiball allein <i>Suction ball only</i>
AJ-002-004	Konus mit Schlauch allein <i>Cone with tube only</i>
AJ-002-005	Schaftanschluss für Ellik allein <i>Sheath connection for Ellik only</i>

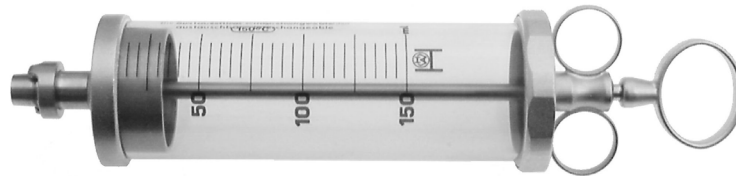

Bestell-Nr. Ordering no.	
AJ-001-000	RECORD Blasenspritze mit Adapter, 50ml <i>RECORD syringe with adapter, 50ml</i>
AJ-001-010	Ersatzzylinder für RECORD Blasenspritze mit Adapter, 50ml <i>Replacement cylinder for RECORD syringe with adapter, 50ml</i>
AJ-001-001	RECORD Blasenspritze mit Adapter, 75ml <i>RECORD syringe with adapter, 75ml</i>
AJ-001-011	Ersatzzylinder für RECORD Blasenspritze mit Adapter, 75ml <i>Replacement cylinder for RECORD syringe with adapter, 75ml</i>
AJ-001-002	RECORD Blasenspritze mit Adapter, 100ml <i>RECORD syringe with adapter, 100ml</i>
AJ-001-012	Ersatzzylinder für RECORD Blasenspritze mit Adapter, 100ml <i>Replacement cylinder for RECORD syringe with adapter, 100ml</i>
AJ-001-003	RECORD Blasenspritze mit Adapter, 150ml <i>RECORD syringe with adapter, 150ml</i>
AJ-001-013	Ersatzzylinder für RECORD Blasenspritze mit Adapter, 150ml <i>Replacement cylinder for RECORD syringe with adapter, 150ml</i>

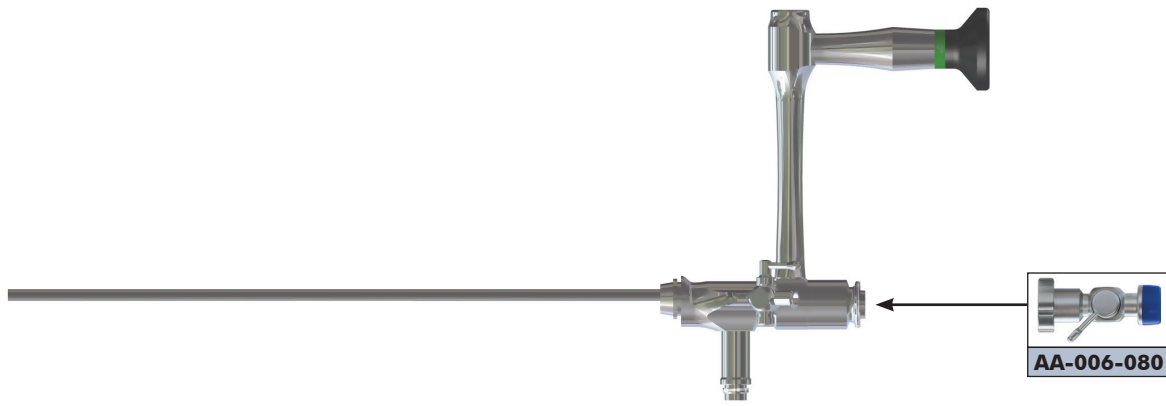

Bestell-Nr. Ordering no.	Arbeitslänge Working length	
AA-006-012	250mm	Nephroskop mit 90° abgewinkeltem Okular, Ø 7.45mm, Blickwinkel 0°, Spülkanal Ø 1.5mm, Arbeitskanal Ø 4.7mm Nephroscope with 90° angled ocular, Ø 7.45mm, viewing angle 0°, suction channel Ø 1.5mm, working channel Ø 4.7mm

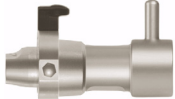
	Bestell-Nr. Ordering no.	
	AB-004-010-QL	Adapter für den Einsatz mit Nephroskop und Resektoskopschäften 26 Charr. STEMA Click-System Adaptor for use with nephroscope and resectoscope sheaths 26 Fr. STEMA Click-System

Bestell-Nr. Ordering no.	
AA-006-080	Durchflusshahn, Ø 6.1mm, zur Benutzung mit STEMA Nephroskopen Flow valve, Ø 6.1mm, used for STEMA nephroscopes
AA-006-081	Dichtungskappe, Ø 15mm/1.0mm Sealing cap, Ø 15mm/1.0mm



Bestell-Nr. Ordering no.	Farbmarkierung Colour code	
AH-001-301	Gelb Yellow	Innenschaft 26 Charr. mit Keramikisolation, drehbar <i>Inner sheath 26 Fr. with ceramic isolation, rotatable</i>



	Bestell-Nr. Ordering no.	Farbmarkierung Colour code	
	AH-001-302	Gelb Yellow	Außenschaft 26 Charr. mit Lochperforation, drehbar <i>Outer sheath 26 Fr. with perforation, rotatable</i>



Bestell-Nr. Ordering no.	Farbmarkierung Colour code	Für Außenschaft For outer sheath	
AH-001-011	Gelb Yellow	26 Charr. 26 Fr.	Standardobturator für Resektoskopschäfte 24 Charr. <i>Standardobturator for resectosope sheaths 24 Fr.</i>

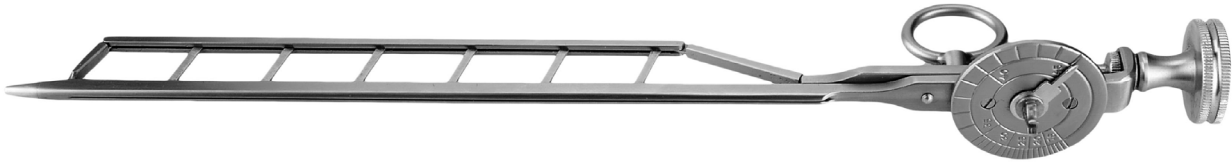

Bestell-Nr.
Ordering no.



AI-002-001

OTIS Urethrotom mit 3 austauschbaren Spitzen inklusive 2 Messern
OTIS urethrotome with 3 exchangeable tips inclusive 2 knives



Bestell-Nr.
Ordering no.

AI-002-002

Ersatzmesser für OTIS Urethrotom
Spare knives for OTIS urethrotome



Info: Die OTIS Urethrotome sind *auf Anfrage* auch für Kinder erhältlich.
Info: The OTIS urethrotomes are *on request* also available for children.



Bestell-Nr.
Ordering no.

AA-002-001	Zystoskop Ø 4.0mm, Blickwinkel 0°, autoklavierbar <i>Cystoscope Ø 4.0mm, 0° viewing angle, autoclavable</i>
AA-002-011	HD Zystoskop Ø 4.0mm, Blickwinkel 0°, autoklavierbar HD Cystoscope Ø 4.0mm, 0° viewing angle, autoclavable
AA-002-021	Ultra HD Zystoskop Ø 4.0mm, Blickwinkel 0°, autoklavierbar Ultra HD Cystoscope Ø 4.0mm, 0° viewing angle, autoclavable

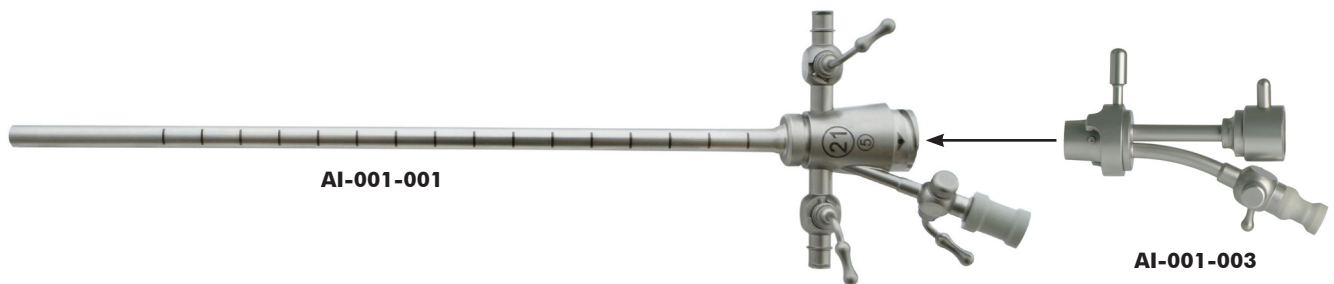

Bestell-Nr.
Ordering no.

AI-001-001	Urethrotomschaft 21 Charr. mit Instrumentenkanal 5 Fr. <i>Urethrotome sheath 21 Fr. with instrument channel 5 Fr.</i>
AI-001-003	Endoskopbrücke mit 1 Instrumentenkanal, passend zu Urethrotomschaft AI-001-001 <i>Endoscope bridge with 1 instrument channel, fit with urethrotome sheath AI-001-001</i>



Bestell-Nr.
Ordering no.

AI-001-002	Zusatzschaft für AI-001-001, seitlich offen <i>Sheath for AI-001-001, open to side</i>
-------------------	---



Bestell-Nr.
Ordering no.

AI-001-006	Zusatzschaft 25 Charr. für Dauerspülung <i>Supplementary sheath 25 Fr. for continuous flow</i>
-------------------	---



**Bestell-Nr.
Ordering no.**

AI-001-004

Standardobturator für Urethrotomschaft 21 Charr.
Standard obturator for urethrotome sheath 21 Fr.



**Bestell-Nr.
Ordering no.**

AI-001-005

Obturator für Urethrotomschaft 21 Charr. mit 5 Charr. Instrumentenkanal
Obturator for urethrotome sheath 21 Fr. with 5 Fr. instrument channel



**Bestell-Nr.
Ordering no.**

AI-001-012

Sichtobturator für Urethrotomschaft 21 Charr.
Viewing obturator for urethrotome sheath 21 Fr.



Bestell-Nr.
Ordering no.

AG-001-001

Arbeitselement für Resektoskope, **passiv** schneidend, Griff **geschlossen**, Schnitt durch Federdruck
Working element used for resectoscopes, **passive** cutting, handle **closed**, cutting spring assisted

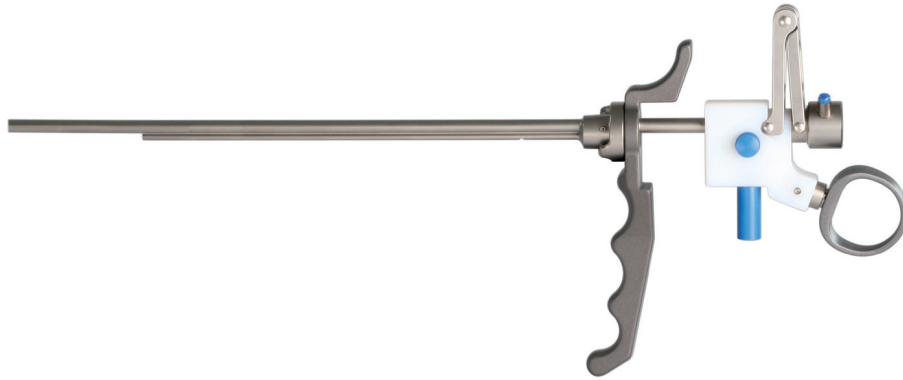

Bestell-Nr.
Ordering no.

AG-001-002

Arbeitselement für Resektoskope, **passiv** schneidend, Griff **offen**, Schnitt durch Federdruck
Working element used for resectoscopes, **passive** cutting, handle **open**, cutting spring assisted



	Bestell-Nr. Ordering no.	
	AI-001-007	Strikturmesser gerade <i>Cold knife straight</i>
	AI-001-008	Strikturmesser gerade, Wellenschliff <i>Cold knife straight, wave shape</i>
	AI-001-009	Strikturmesser rund <i>Cold knife round</i>
	AI-001-011	Strikturmesser hakenförmig <i>Cold knife hook shaped</i>



Bestell-Nr.
Ordering no.

AJ-010-006

Schutzhülse aus Stahl zur Sterilisation und Aufbewahrung von Elektroden und Strikturmessern
Protection sleeve made of steel for sterilization and storage of electrodes and cold knives



Bestell-Nr.
Ordering no.

AA-003-001 Zystoskop Ø 2.9mm, Blickwinkel 0°, autoklavierbar
Cystoscope Ø 2.9mm, 0° viewing angle, autoclavable

AA-003-011 **HD** Zystoskop Ø 2.9mm, Blickwinkel 0°, autoklavierbar
HD *Cystoscope Ø 2.9mm, 0° viewing angle, autoclavable*

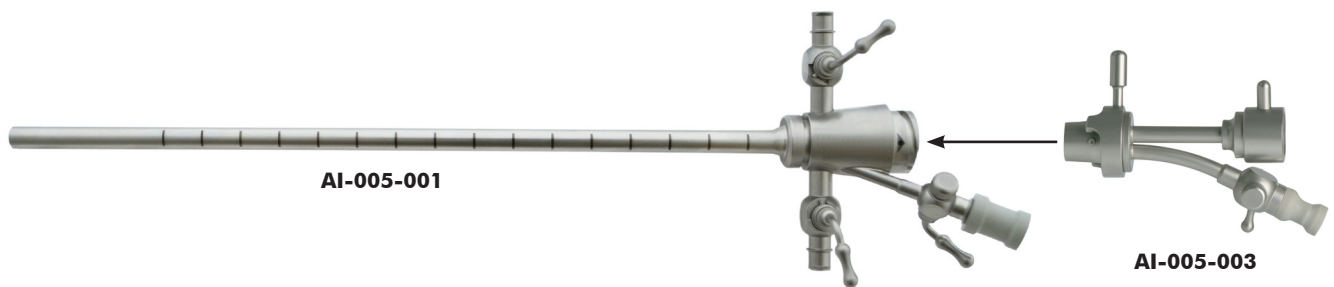

Bestell-Nr.
Ordering no.

AI-005-001 Urethrotomschaft 15.5 Charr. mit Instrumentenkanal 3 Charr.
Urethrotome sheath 15.5 Fr. with instrument channel 3 Fr.

AI-005-003 Endoskopbrücke mit 1 Instrumentenkanal, passend zu Urethrotomschaft AI-005-001
Endoscope bridge with 1 instrument channel, fit with urethrotome sheath AI-005-001



Bestell-Nr.
Ordering no.

AI-005-004 Standardobturator für Urethrotomschaft 15.5 Charr.
Standard obturator for urethrotome sheath 15.5 Fr.



**Bestell-Nr.
 Ordering no.**

AG-001-010

Arbeitselement für Resektoskope, **passiv** schneidend, Griff geschlossen ohne HF-Anschluss
 Working element used for resectoscopes, **passive** cutting, handle closed without HF-connection



**Bestell-Nr.
 Ordering no.**



AI-005-007

Strikturmesser gerade
 Cold knife straight



AI-005-008

Strikturmesser gerade, Wellenschliff
 Cold knife straight, wave shape



AI-005-011

Strikturmesser hakenförmig
 Cold knife hook shaped



**Bestell-Nr.
 Ordering no.**

AJ-010-006

Schutzhülse aus Stahl zur Sterilisation und Aufbewahrung von Elektroden und Strikturmessern
 Protection sleeve made of steel for sterilization and storage of electrodes and cold knives

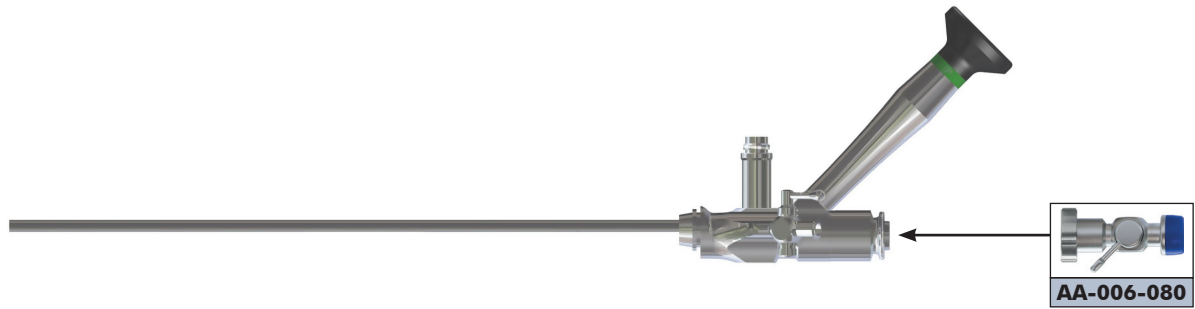

Bestell-Nr. Ordering no.	Arbeitslänge Working length	
AA-006-001	200mm	Nephroskop mit 45° abgewinkeltem Okular, Ø 7.45mm, Blickwinkel 0° , Spülkanal Ø 1.5mm, Arbeitskanal Ø 4.7mm <i>Nephroscope with 45° angled ocular, Ø 7.45mm, viewing angle 0°, suction channel Ø 1.5mm, working channel Ø 4.7mm</i>
AA-006-021	200mm	Nephroskop mit 45° abgewinkeltem Okular, Ø 7.45mm, Blickwinkel 6° , Spülkanal Ø 1.5mm, Arbeitskanal Ø 4.7mm <i>Nephroscope with 45° angled ocular, Ø 7.45mm, viewing angle 6°, suction channel Ø 1.5mm, working channel Ø 4.7mm</i>
AA-006-004	200mm	Nephroskop mit 45° abgewinkeltem Okular, Ø 7.45mm, Blickwinkel 15° , Spülkanal Ø 1.5mm, Arbeitskanal Ø 4.7mm <i>Nephroscope with 45° angled ocular, Ø 7.45mm, viewing angle 15°, suction channel Ø 1.5mm, working channel Ø 4.7mm</i>

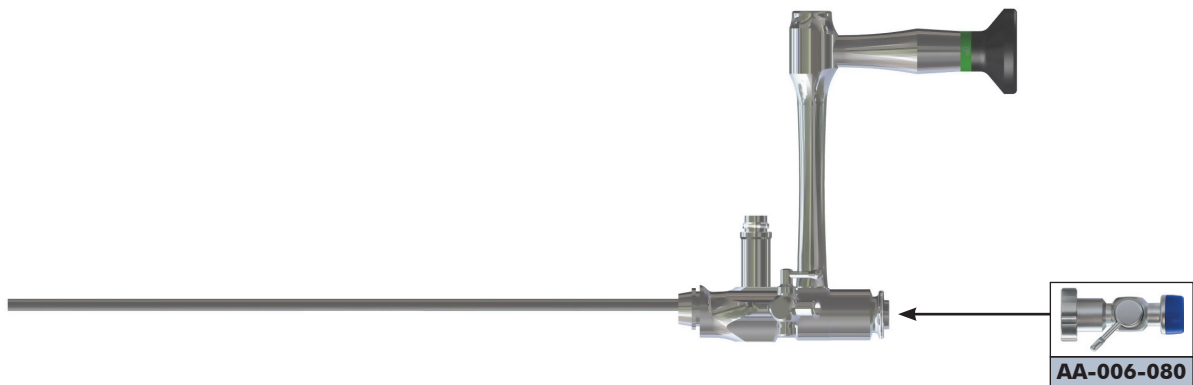

Bestell-Nr. Ordering no.	Arbeitslänge Working length	
AA-006-002	200mm	Nephroskop mit 90° abgewinkeltem Okular, Ø 7.45mm, Blickwinkel 0° , Spülkanal Ø 1.5mm, Arbeitskanal Ø 4.7mm <i>Nephroscope with 90° angled ocular, Ø 7.45mm, viewing angle 0°, suction channel Ø 1.5mm, working channel Ø 4.7mm</i>
AA-006-022	200mm	Nephroskop mit 90° abgewinkeltem Okular, Ø 7.45mm, Blickwinkel 6° , Spülkanal Ø 1.5mm, Arbeitskanal Ø 4.7mm <i>Nephroscope with 90° angled ocular, Ø 7.45mm, viewing angle 6°, suction channel Ø 1.5mm, working channel Ø 4.7mm</i>
AA-006-005	200mm	Nephroskop mit 90° abgewinkeltem Okular, Ø 7.45mm, Blickwinkel 15° , Spülkanal Ø 1.5mm, Arbeitskanal Ø 4.7mm <i>Nephroscope with 90° angled ocular, Ø 7.45mm, viewing angle 15°, suction channel Ø 1.5mm, working channel Ø 4.7mm</i>

Bestell-Nr. Ordering no.	
AA-006-080	Durchflusshahn, Ø 6.1mm, zur Benutzung mit STEMA Nephroskopen <i>Flow valve, Ø 6.1mm, used for STEMA nephroscopes</i>
AA-006-081	Dichtungskappe, Ø 15mm/1.0mm (ohne Abbildung) <i>Sealing cap, Ø 15mm/1.0mm (without illustration)</i>
AJ-010-015	Spülhahn links, gross (Durchlass 4.0mm), mit LL-Anschluss und Schlauchansatz, M 6 x 0.35mm (ohne Abbildung) <i>Stopcock left, large (passage 4mm), with LL-connection and tube attachment, M 6 x 0.35mm (without illustration)</i>



**Bestell-Nr.
Ordering no.**

AB-006-001	Nephroskopschaft zur Dauerspülung, Hahn <u>drehbar</u> , 24 Charr. (passend für Nephroskope AL 200mm) Nephroscope sheath for continous flow, <u>rotatable</u> stopcock, 24 Fr. (fit with nephrosopes WL 200mm)
AB-006-007	Nephroskopschaft zur Dauerspülung, Hahn <u>drehbar</u> , 26 Charr. (passend für Nephroskope AL 200mm) Nephroscope sheath for continous flow, <u>rotatable</u> stopcock, 26 Fr. (fit with nephrosopes WL 200mm)
AB-006-005	Nephroskopschaft zur Dauerspülung, Hahn <u>feststehend</u> , 24 Charr. (passend für Nephroskope AL 200mm) Nephroscope sheath for continous flow, <u>fixed</u> stopcock, 24 Fr. (fit with all nephrosopes with WL 200mm)
AB-006-006	Nephroskopschaft zur Dauerspülung, Hahn <u>feststehend</u> , 26 Charr. (passend für Nephroskope AL 200mm) Nephroscope sheath for continous flow, <u>fixed</u> stopcock, 26 Fr. (fit with nephrosopes WL 200mm)

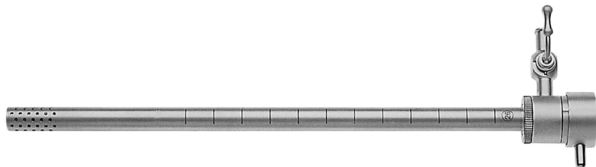

**Bestell-Nr.
Ordering no.**

AB-006-003	Nephroskopschaft zur Dauerspülung, perforiert, Hahn <u>drehbar</u> , 26 Charr. (passend für Nephroskope AL 200mm) Nephroscope sheath for continous flow, perforated, <u>rotatable</u> stopcock, 26 Fr. (fit with nephrosopes WL 200mm)
AB-006-008	Nephroskopschaft zur Dauerspülung, perforiert, Hahn <u>feststehend</u> , 26 Charr. (passend für Nephroskope AL 200mm) Nephroscope sheath for continous flow, perforated, <u>fixed</u> stopcock, 26 Fr. (fit with nephrosopes WL 200mm)



**Bestell-Nr.
Ordering no.**

AB-006-002	Obturator hohl 24 Charr. für 24 Charr. Nephroskopieschäfte (200mm) Obturator hollow 24 Fr. used for 24 Fr. nephroscopy sheaths (200mm)
AB-006-004	Obturator hohl 26 Charr. für 26 Charr. Nephroskopieschäfte (200mm) Obturator hollow 26 Fr. used for 26 Fr. nephroscopy sheaths (200mm)

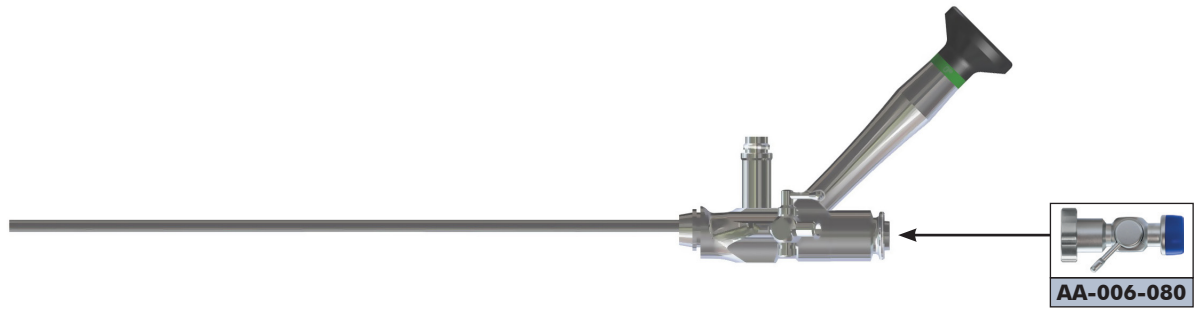

Bestell-Nr. Ordering no.	Arbeitslänge Working length	
AA-006-011	250mm	Nephroskop mit 45° abgewinkeltem Okular, Ø 7.45mm, Blickwinkel 0° , Spülkanal Ø 1.5mm, Arbeitskanal Ø 4.7mm <i>Nephroscope with 45° angled ocular, Ø 7.45mm, viewing angle 0°, suction channel Ø 1.5mm, working channel Ø 4.7mm</i>
AA-006-031	250mm	Nephroskop mit 45° abgewinkeltem Okular, Ø 7.45mm, Blickwinkel 6° , Spülkanal Ø 1.5mm, Arbeitskanal Ø 4.7mm <i>Nephroscope with 45° angled ocular, Ø 7.45mm, viewing angle 6°, suction channel Ø 1.5mm, working channel Ø 4.7mm</i>
AA-006-034	250mm	Nephroskop mit 45° abgewinkeltem Okular, Ø 7.45mm, Blickwinkel 15° , Spülkanal Ø 1.5mm, Arbeitskanal Ø 4.7mm <i>Nephroscope with 45° angled ocular, Ø 7.45mm, viewing angle 15°, suction channel Ø 1.5mm, working channel Ø 4.7mm</i>

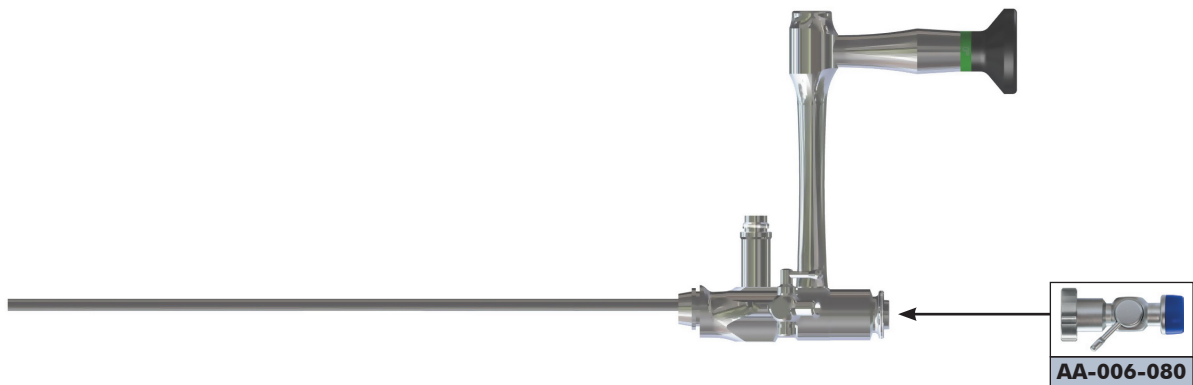

Bestell-Nr. Ordering no.	Arbeitslänge Working length	
AA-006-012	250mm	Nephroskop mit 90° abgewinkeltem Okular, Ø 7.45mm, Blickwinkel 0° , Spülkanal Ø 1.5mm, Arbeitskanal Ø 4.7mm <i>Nephroscope with 90° angled ocular, Ø 7.45mm, viewing angle 0°, suction channel Ø 1.5mm, working channel Ø 4.7mm</i>
AA-006-032	250mm	Nephroskop mit 90° abgewinkeltem Okular, Ø 7.45mm, Blickwinkel 6° , Spülkanal Ø 1.5mm, Arbeitskanal Ø 4.7mm <i>Nephroscope with 90° angled ocular, Ø 7.45mm, viewing angle 6°, suction channel Ø 1.5mm, working channel Ø 4.7mm</i>
AA-006-006	250mm	Nephroskop mit 90° abgewinkeltem Okular, Ø 7.45mm, Blickwinkel 15° , Spülkanal Ø 1.5mm, Arbeitskanal Ø 4.7mm <i>Nephroscope with 90° angled ocular, Ø 7.45mm, viewing angle 15°, suction channel Ø 1.5mm, working channel Ø 4.7mm</i>

Bestell-Nr. Ordering no.	
AA-006-080	Durchflusshahn, Ø 6.1mm, zur Benutzung mit STEMA Nephroskopen <i>Flow valve, Ø 6.1mm, used for STEMA nephroscopes</i>
AA-006-081	Dichtungskappe, Ø 15mm/1.0mm (ohne Abbildung) <i>Sealing cap, Ø 15mm/1.0mm (without illustration)</i>
AJ-010-015	Spülhahn links, gross (Durchlass 4.0mm), mit LL-Anschluss und Schlauchansatz, M 6 x 0.35mm (ohne Abbildung) <i>Stopcock left, large (passage 4mm), with LL-connection and tube attachment, M 6 x 0.35mm (without illustration)</i>



Bestell-Nr.
Ordering no.

AB-006-061	Nephroskopschaft zur Dauerspülung, Hahn <u>drehbar</u> , 24 Charr. (passend für Nephroskope AL 250mm) <i>Nephroscope sheath for continous flow, <u>rotatable</u> stopcock, 24 Fr. (fit with nephrosopes WL 250mm)</i>
AB-006-067	Nephroskopschaft zur Dauerspülung, Hahn <u>drehbar</u> , 26 Charr. (passend für Nephroskope AL 250mm) <i>Nephroscope sheath for continous flow, <u>rotatable</u> stopcock, 26 Fr. (fit with nephrosopes WL 250mm)</i>
AB-006-065	Nephroskopschaft zur Dauerspülung, Hahn <u>feststehend</u> , 24 Charr. (passend für Nephroskope AL 250mm) <i>Nephroscope sheath for continous flow, <u>fixed</u> stopcock, 24 Fr. (fit with all nephrosopes with WL 250mm)</i>
AB-006-066	Nephroskopschaft zur Dauerspülung, Hahn <u>feststehend</u> , 26 Charr. (passend für Nephroskope AL 250mm) <i>Nephroscope sheath for continous flow, <u>fixed</u> stopcock, 26 Fr. (fit with nephrosopes WL 250mm)</i>



Bestell-Nr.
Ordering no.

AB-006-063	Nephroskopschaft zur Dauerspülung, perforiert, Hahn <u>drehbar</u> , 26 Charr. (passend für Nephroskope AL 250mm) <i>Nephroscope sheath for continous flow, perforated, <u>rotatable</u> stopcock, 26 Fr. (fit with nephrosopes WL 250mm)</i>
AB-006-068	Nephroskopschaft zur Dauerspülung, perforiert, Hahn <u>feststehend</u> , 26 Charr. (passend für Nephroskope AL 250mm) <i>Nephroscope sheath for continous flow, perforated, <u>fixed</u> stopcock, 26 Fr. (fit with nephrosopes WL 250mm)</i>



Bestell-Nr.
Ordering no.

AB-006-062	Obturator hohl 24 Charr. für 24 Charr. Nephroskopieschäfte (250mm) <i>Obturator hollow 24 Fr. used for 24 Fr. nephroscopy sheaths (250mm)</i>
AB-006-064	Obturator hohl 26 Charr. für 26 Charr. Nephroskopieschäfte (250mm) <i>Obturator hollow 26 Fr. used for 26 Fr. nephroscopy sheaths (250mm)</i>



Bestell-Nr. Ordering no.	
AB-006-011	Satz Teleskop-Bougies bestehend aus: 6 Dilatationshülsen 9, 12, 15, 18, 21 und 24 Charr. mit 1 starren und 1 flexiblen Führungssonde <i>Set of telescope bougies consisting of: 6 dilating bougies 9, 12, 15, 18, 21 and 24 Fr., incl. 1 rigid and 1 flexible guide probe</i>
AB-006-012	Führungssonde, starr <i>Guide probe, rigid</i>
AB-006-013	Führungssonde, flexibel <i>Guide probe, flexible</i>
AB-006-020	Dilatationshülse 9 Charr. <i>Dilatating sheath 9 Fr.</i>
AB-006-021	Dilatationshülse 12 Charr. <i>Dilatating sheath 12 Fr.</i>
AB-006-022	Dilatationshülse 15 Charr. <i>Dilatating sheath 15 Fr.</i>
AB-006-023	Dilatationshülse 18 Charr. <i>Dilatating sheath 18 Fr.</i>
AB-006-024	Dilatationshülse 21 Charr. <i>Dilatating sheath 21 Fr.</i>
AB-006-025	Dilatationshülse 24 Charr. <i>Dilatating sheath 24 Fr.</i>
AB-006-026	Dilatationshülse 27 Charr. <i>Dilatating sheath 27 Fr.</i>
AB-006-027	Dilatationshülse 30 Charr. <i>Dilatating sheath 30 Fr.</i>

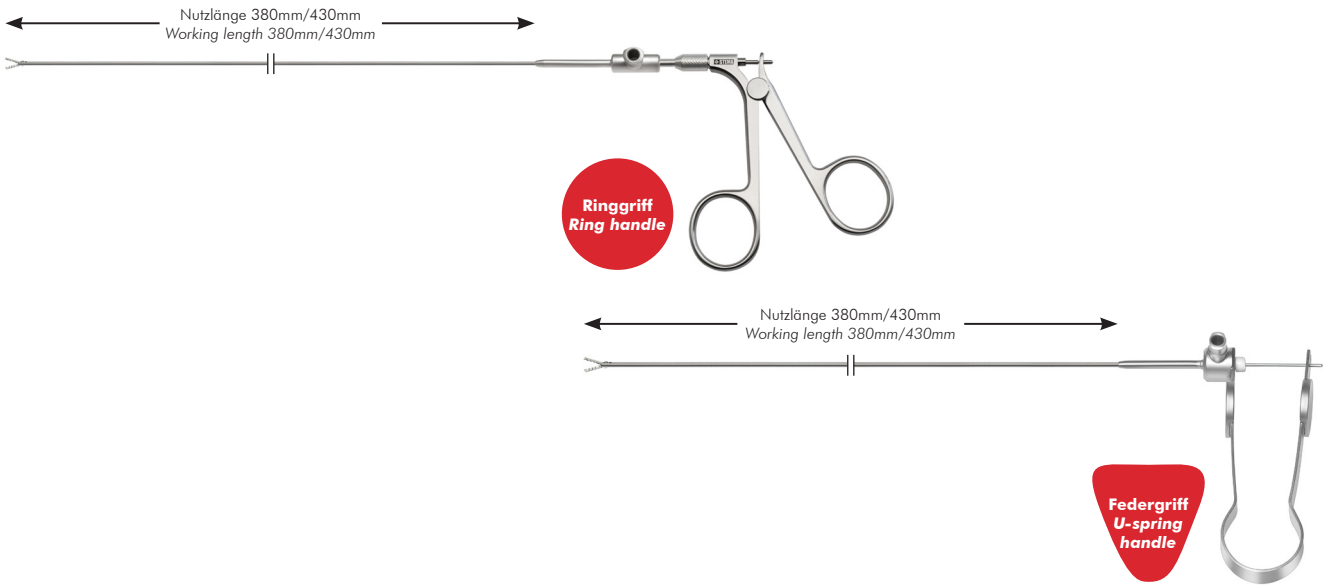

	Bestell-Nr. Ordering no.	Arbeitslänge Working length	Ømm	
	AB-006-046	380mm	3.5	Steinfaßzange, gefensterter Maul, mit Federgriff
	AB-006-040	430mm	3.5	Stone grasping forceps, fenestrated, with U-spring handle
	AB-006-048	400mm	3.5	Steinfaßzange, gefensterter Maul, mit Ringgriff
	AB-006-042	400mm	3.5	Stone grasping forceps, fenestrated, with ring handle
	AB-006-047	380mm	3.5	Dreiarmsgreifer, grosse Steine, mit Federgriff
	AB-006-041	430mm	3.5	3-Prongs retriever, larger stones, with U-spring handle
	AB-006-049	380mm	3.5	Probeexzisionszange, oval, mit Ringgriff
	AB-006-043	430mm	3.5	Biopsy forceps, oval, with ring handle
	AB-006-050	380mm	3.5	Fasszange Alligatormaul, mit Ringgriff
	AB-006-044	430mm	3.5	Grasping forceps alligator jaw, with ring handle
	AB-006-051	380mm	3.5	Schere, spitz, mit Ringgriff
	AB-006-045	430mm	3.5	Scissors, pointed, with ring handle

STEMA High Definition

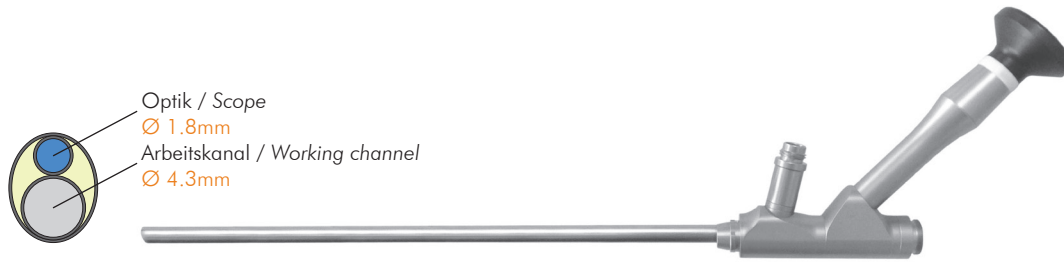

Bestell-Nr. Ordering no.	Arbeitslänge Working length	
AA-006-069	220mm	HD Nephroskop mit 45° abgewinkeltem Okular, Ø 18.8 Ch., Blickwinkel 0° , Arbeitskanal Ø 12.9 Ch. <i>HD nephroscope with 45° angled ocular, Ø 18.8 Fr., viewing angle 0°, working channel Ø 12.9 Fr.</i>
AA-006-070	220mm	HD Nephroskop mit 45° abgewinkeltem Okular, Ø 18.8 Ch., Blickwinkel 15° , Arbeitskanal Ø 12.9 Ch. <i>HD nephroscope with 45° angled ocular, Ø 18.8 Fr., viewing angle 15°, working channel Ø 12.9 Fr.</i>









Bestell-Nr. Ordering no.	
AB-006-170	Nephroskopschaft zur Dauerspülung, Hahn drehbar, 23 Charr. (passend für Nephroskope AL 220mm / Optik 15°) <i>Nephroscope sheath for continous flow, rotatable stopcock, 23 Fr. (fit with nephroscopes WL 220mm / scope 15°)</i>

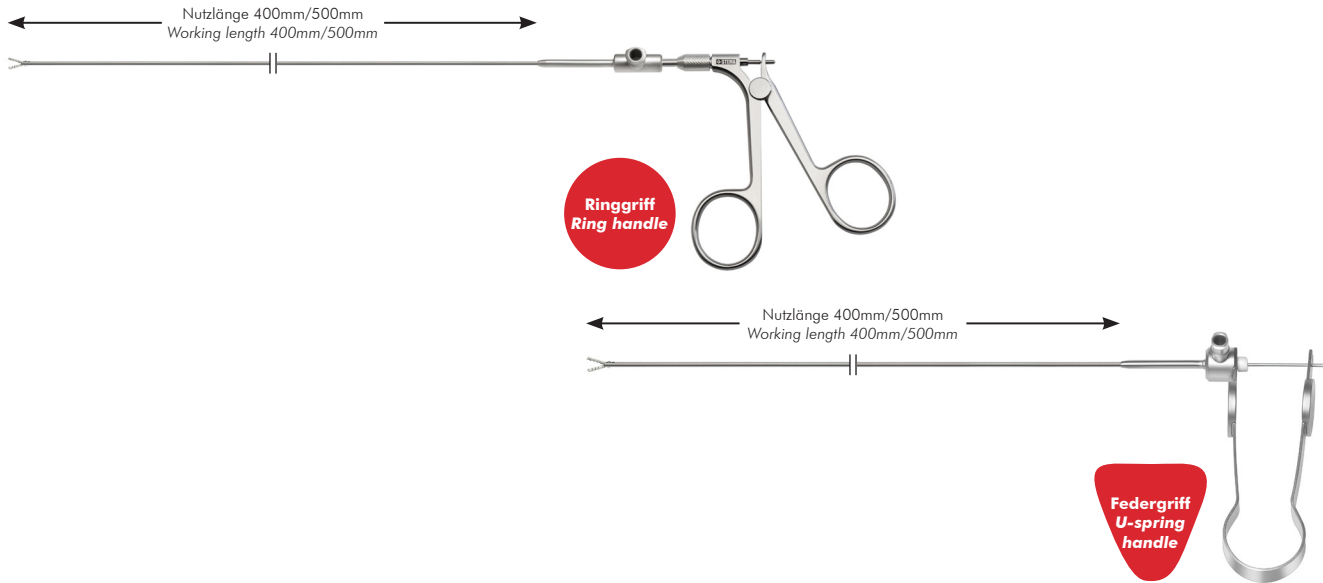

Bestell-Nr. Ordering no.	
AB-006-171	Obturator hohl, 23 Charr. (passend für Nephroskopieschaft AB-006-170 / Optik 15°) <i>Obturator hollow, 23 Fr. (fit with nephroscopy sheath AB-006-170 / scope 15°)</i>

Bestell-Nr. Ordering no.	
AA-006-081	Dichtungskappe, Ø 15mm/1.0mm <i>Sealing cap, Ø 15mm/1.0mm</i>



	Bestell-Nr. Ordering no.	Arbeitslänge Working length	Ømm	
	AB-006-242	400mm	1.8	Steinfaßzange, gefensterter Maul, doppelbeweglich, starr, mit Ringgriff
	AB-006-342	500mm	1.8	Fenestrated stone grasping forceps, double action, rigid, with ring handle
	AB-006-442	400mm	3.0	
	AB-006-243	400mm	1.8	Probeexzisionszange, oval, einfachbeweglich, starr, mit Ringgriff
	AB-006-343	500mm	1.8	Biopsy forceps, oval, single action, rigid, with ring handle
	AB-006-443	400mm	3.0	
	AB-006-244	400mm	1.8	Fasszange Alligatormaul, doppelbeweglich, starr, mit Ringgriff
	AB-006-344	500mm	1.8	Grasping forceps alligator jaw, double action, rigid, with ring handle
	AB-006-444	400mm	3.0	
	AB-006-245	400mm	1.8	Schere, spitz, starr, einfachbeweglich, mit Ringgriff
	AB-006-345	500mm	1.8	Scissors, pointed, rigid, single action, with ring handle
	AB-006-445	400mm	3.0	
	AB-006-246	400mm	1.8	Dreiarmgreifer, starr, mit Federgriff
	AB-006-346	500mm	1.8	3-Prongs retriever, rigid, with U-spring handle
	AB-006-446	400mm	3.0	

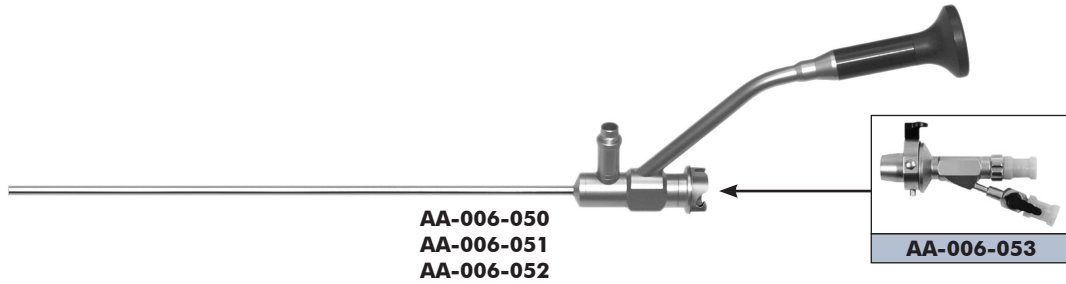

Bestell-Nr. Ordering no.	Arbeitslänge Working length	
AA-006-050	220mm	Mini-Nephroskop mit 45° abgewinkeltem Okular, Ø 19 Charr., Blickwinkel 8°, Arbeitskanal 10 Charr. <i>Mini nephroscope with 45° angled ocular, Ø 19 Fr., viewing angle 8°, instrument channel 10 Fr.</i>
AA-006-051	220mm	Mini-Nephroskop mit 45° abgewinkeltem Okular, Ø 13.5 Charr., Blickwinkel 8°, Arbeitskanal 6 Charr. <i>Mini nephroscope with 45° angled ocular, Ø 13.5 Fr., viewing angle 8°, instrument channel 6 Fr.</i>
AA-006-052	320mm	Mini-Nephroskop mit 45° abgewinkeltem Okular, Ø 13.5 Charr., Blickwinkel 8°, Arbeitskanal 6 Charr. <i>Mini nephroscope with 45° angled ocular, Ø 13.5 Fr., viewing angle 8°, instrument channel 6 Fr.</i>

Bestell-Nr. Ordering no.	
AA-006-053	Instrumentenbrücke für Mini-Nephroskope - ACHTUNG: Nicht im Lieferumfang enthalten! Bitte zusätzlich bestellen. <i>Instrument bridge used for Mini-Nephroskope - ATTENTION: Not included in the delivery content! Please order additionally.</i>

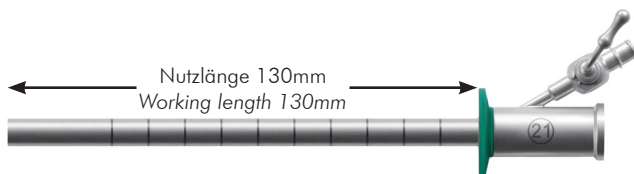

Bestell-Nr. Ordering no.	Farbmarkierung Colour code	
AB-006-100	Rot Red	Mini-Nephroskopschaft ohne Perforation zur Dauerspülung, Hahn fest, 15/18 Charr. <i>Mini nephroscope sheath without perforation, continous flow, stopcock fixed, 15/18 Fr.</i>
AB-006-101	Blau Blue	Mini-Nephroskopschaft ohne Perforation zur Dauerspülung, Hahn fest, 16.5/19.5 Charr. <i>Mini nephroscope sheath without perforation, continous flow, stopcock fixed, 16.5/19.5 Fr.</i>
AB-006-102	Grün Green	Mini-Nephroskopschaft ohne Perforation zur Dauerspülung, Hahn fest, 21/24 Charr. <i>Mini nephroscope sheath without perforation, continous flow, stopcock fixed, 21/24 Fr.</i>



Bestell-Nr. Ordering no.	
AB-006-110	Dilatator 15/18 Charr. mit zentraler Bohrung Ø 3 Charr. <i>Dilatator 15/18 Fr. with central cannulation Ø 3 Fr.</i>
AB-006-111	Dilatator 16/19.5 Charr. mit 2 Kanälen Ø 2x3 Charr. <i>Dilatator 16/19.5 Fr. with 2 channels Ø 2x3 Fr.</i>
AB-006-112	Dilatator 21/24 Charr. mit 2 Kanälen Ø 2x5 Charr. <i>Dilatator 21/24 Fr. with 2 channels Ø 2x5 Fr.</i>



Bestell-Nr. Ordering no.	
AB-006-115	Applikator für die Benutzung der Mini-Nephroskopschäfte, inkl. Stößel <i>Applicator used for the mini nephroscope sheaths, incl. plunger</i>

STEMA **High Definition**

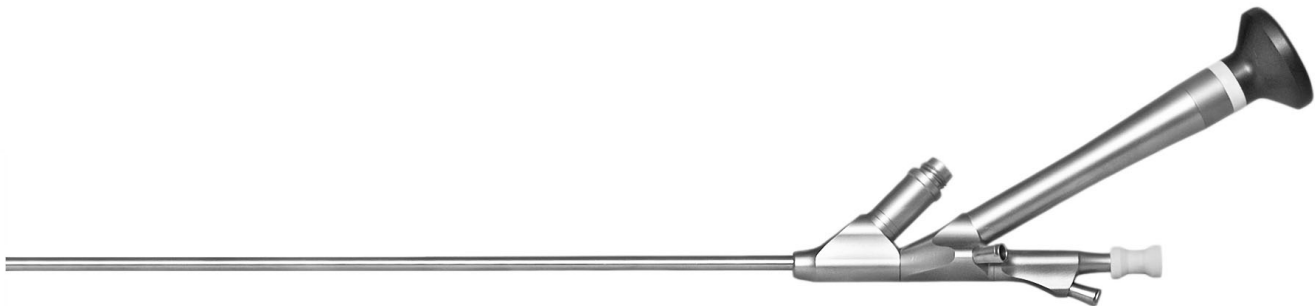

Bestell-Nr.
Ordering no.

AA-006-100

Mini HD Kompakt-Nephroskop mit 30° abgewinkeltem Okular, Schaft 12 Charr., Blickwinkel 0°, Arbeitslänge 220mm, Instrumentenkanal 6.6 Charr., 3 Luer-Lock Anschlüsse, 40.000 Pixel
Mini HD compact nephroscope with 30° angled ocular, sheath 12 Fr., viewing angle 0°, working length 220mm, instrument channel 6.6 Fr., 3 luerlock connections, 40.000 pixel

AA-006-101

Mini HD Kompakt-Nephroskop mit 30° abgewinkeltem Okular, Schaft 9 Charr., Blickwinkel 0°, Arbeitslänge 220mm, Instrumentenkanal 4.8 Charr., 3 Luer-Lock Anschlüsse, 17.000 Pixel
Mini HD compact nephroscope with 30° angled ocular, sheath 9 Fr., viewing angle 0°, working length 220mm, instrument channel 4.8 Fr., 3 luerlock connections, 17.000 pixel

AA-006-102

Mini HD Kompakt-Nephroskop mit 30° abgewinkeltem Okular, Schaft 8.1 Charr., Blickwinkel 0°, Arbeitslänge 220mm, Instrumentenkanal 3.6 Charr., 3 Luer-Lock Anschlüsse, 17.000 Pixel
Mini HD compact nephroscope with 30° angled ocular, sheath 8.1 Fr., viewing angle 0°, working length 220mm, instrument channel 3.6 Fr., 3 luerlock connections, 17.000 pixel

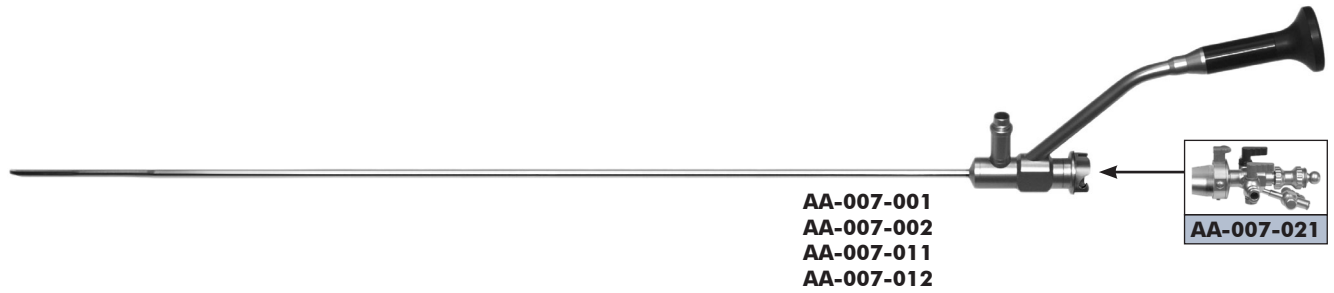

Bestell-Nr. Ordering no.	Arbeitslänge Working length	
AA-007-001	310mm	Halbstarres Uretero-Renoskop mit 45° abgewinkeltem Okular, Ø stufenförmig von 9.5 bis 10.5 Charr., Blickwinkel 8°, Arbeitskanal 5 Charr. <i>Semirigid uretero-renaloscope with 45° angled ocular, Ø steps from 9.5 to 10.5 Fr., viewing angle 8°, instrument channel 5 Fr.</i>
AA-007-011	310mm	Halbstarres Uretero-Renoskop mit 45° abgewinkeltem Okular, Ø stufenförmig von 6.0 bis 7.5 Charr., Blickwinkel 8°, Arbeitskanal 4 Charr. <i>Semirigid uretero-renaloscope with 45° angled ocular, Ø steps from 6.0 to 7.5 Fr., viewing angle 8°, instrument channel 4 Fr.</i>
AA-007-002	425mm	Halbstarres Uretero-Renoskop mit 45° abgewinkeltem Okular, Ø stufenförmig von 9.5 bis 10.5 Charr., Blickwinkel 8°, Arbeitskanal 5 Charr. <i>Semirigid uretero-renaloscope with 45° angled ocular, Ø steps from 9.5 to 10.5 Fr., viewing angle 8°, instrument channel 5 Fr.</i>
AA-007-012	425mm	Halbstarres Uretero-Renoskop mit 45° abgewinkeltem Okular, Ø stufenförmig von 6.0 bis 7.5 Charr., Blickwinkel 8°, Arbeitskanal 4 Charr. <i>Semirigid uretero-renaloscope with 45° angled ocular, Ø steps from 6.0 to 7.5 Fr., viewing angle 8°, instrument channel 4 Fr.</i>
Bestell-Nr. Ordering no.		
AA-007-021		Instrumentenbrücke für Uretero-Renoscope (im Lieferumfang enthalten) <i>Instrument bridge used for uretero-renaloscopes (included in the delivery content)</i>



Bestell-Nr. Ordering no.	Arbeitslänge Working length	
AA-007-056	310mm	BICHLER halbstarres Uretero-Renoskop mit 45° abgewinkeltem Okular, Ø stufenförmig von 4.5 bis 6.5 Charr., Blickwinkel 12°, Arbeitskanal 1 x 3.3 Charr. <i>BICHLER semirigid uretero-renaloscope with 45° angled ocular, Ø steps from 4.5 to 6.5 Fr., viewing angle 12°, working channel 1 x 3.3 Fr.</i>
AA-007-055	430mm	BICHLER halbstarres Uretero-Renoskop mit 45° abgewinkeltem Okular, Ø stufenförmig von 4.5 bis 6.5 Charr., Blickwinkel 12°, Arbeitskanal 1 x 3.3 Charr. <i>BICHLER semirigid uretero-renaloscope with 45° angled ocular, Ø steps from 4.5 to 6.5 Fr., viewing angle 12°, working channel 1 x 3.3 Fr.</i>
AA-007-043	310mm	BICHLER halbstarres Uretero-Renoskop mit 45° abgewinkeltem Okular, Ø stufenförmig von 6.0 bis 7.5 Charr., Blickwinkel 12°, Arbeitskanal 1 x 4 Charr. oder 2 x 2.4 Charr. <i>BICHLER semirigid uretero-renaloscope with 45° angled ocular, Ø steps from 6.0 to 7.5 Fr., viewing angle 12°, working channel 1 x 4 Fr. or 2 x 2.4 Fr.</i>
AA-007-044	430mm	BICHLER halbstarres Uretero-Renoskop mit 45° abgewinkeltem Okular, Ø stufenförmig von 6.0 bis 7.5 Charr., Blickwinkel 12°, Arbeitskanal 1 x 4 Charr. oder 2 x 2.4 Charr. <i>BICHLER semirigid uretero-renaloscope with 45° angled ocular, Ø steps from 6.0 to 7.5 Fr., viewing angle 12°, working channel 1 x 4 Fr. or 2 x 2.4 Fr.</i>
AA-007-047	310mm	BICHLER halbstarres Uretero-Renoskop mit 45° abgewinkeltem Okular, Ø stufenförmig von 8.0 bis 9.8 Charr., Blickwinkel 12°, Arbeitskanal 1 x 5 Charr. oder 2 x 3 Charr. <i>BICHLER semirigid uretero-renaloscope with 45° angled ocular, Ø steps from 8.0 to 9.8 Fr., viewing angle 12°, working channel 1 x 5 Fr. or 2 x 3 Fr.</i>
AA-007-048	430mm	BICHLER halbstarres Uretero-Renoskop mit 45° abgewinkeltem Okular, Ø stufenförmig von 8.0 bis 9.8 Charr., Blickwinkel 12°, Arbeitskanal 1 x 5 Charr. oder 2 x 3 Charr. <i>BICHLER semirigid uretero-renaloscope with 45° angled ocular, Ø steps from 8.0 to 9.8 Fr., viewing angle 12°, working channel 1 x 5 Fr. or 2 x 3 Fr.</i>
AA-007-051	310mm	BICHLER halbstarres Uretero-Renoskop mit 45° abgewinkeltem Okular, Ø stufenförmig von 8.5 bis 11.5 Charr., Blickwinkel 12°, Arbeitskanal 1 x 6 Charr. oder 2 x 4 Charr. <i>BICHLER semirigid uretero-renaloscope with 45° angled ocular, Ø steps from 8.5 to 11.5 Fr., viewing angle 12°, working channel 1 x 6 Fr. or 2 x 4 Fr.</i>
AA-007-052	430mm	BICHLER halbstarres Uretero-Renoskop mit 45° abgewinkeltem Okular, Ø stufenförmig von 8.5 bis 11.5 Charr., Blickwinkel 12°, Arbeitskanal 1 x 6 Charr. oder 2 x 4 Charr. <i>BICHLER semirigid uretero-renaloscope with 45° angled ocular, Ø steps from 8.5 to 11.5 Fr., viewing angle 12°, working channel 1 x 6 Fr. or 2 x 4 Fr.</i>

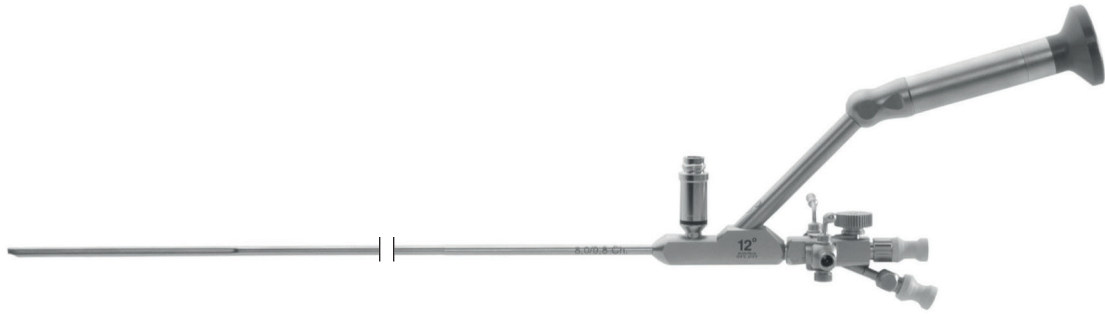

Bestell-Nr. Ordering no.	Arbeitslänge Working length	
AA-007-054	310mm	MARBERGER halbstarres Uretero-Renoskop mit 45° abgewinkeltem Okular, Ø stufenförmig von 4.5 bis 6.5 Charr., Blickwinkel 5°, Arbeitskanal 1 x 3.3 Charr. <i>MARBERGER semirigid uretero-renaloscope with 45° angled ocular, Ø steps from 4.5 to 6.5 Fr., viewing angle 5°, instrument channel 1 x 3.3 Fr.</i>
AA-007-053	430mm	MARBERGER halbstarres Uretero-Renoskop mit 45° abgewinkeltem Okular, Ø stufenförmig von 4.5 bis 6.5 Charr., Blickwinkel 5°, Arbeitskanal 1 x 3.3 Charr. <i>MARBERGER semirigid uretero-renaloscope with 45° angled ocular, Ø steps from 4.5 to 6.5 Fr., viewing angle 5°, instrument channel 1 x 3.3 Fr.</i>
AA-007-041	310mm	MARBERGER halbstarres Uretero-Renoskop mit 45° abgewinkeltem Okular, Ø stufenförmig von 6.0 bis 7.5 Charr., Blickwinkel 12°, Arbeitskanal 1 x 4 Charr. oder 2 x 2.4 Charr. <i>MARBERGER semirigid uretero-renaloscope with 45° angled ocular, Ø steps from 6.0 to 7.5 Fr., viewing angle 12°, instrument channel 1 x 4 Fr. or 2 x 2.4 Fr.</i>
AA-007-042	430mm	MARBERGER halbstarres Uretero-Renoskop mit 45° abgewinkeltem Okular, Ø stufenförmig von 6.0 bis 7.5 Charr., Blickwinkel 12°, Arbeitskanal 1 x 4 Charr. oder 2 x 2.4 Charr. <i>MARBERGER semirigid uretero-renaloscope with 45° angled ocular, Ø steps from 6.0 to 7.5 Fr., viewing angle 12°, instrument channel 1 x 4 Fr. or 2 x 2.4 Fr.</i>
AA-007-045	310mm	MARBERGER halbstarres Uretero-Renoskop mit 45° abgewinkeltem Okular, Ø stufenförmig von 8.0 bis 9.8 Charr., Blickwinkel 12°, Arbeitskanal 1 x 5 Charr. oder 2 x 3 Charr. <i>MARBERGER semirigid uretero-renaloscope with 45° angled ocular, Ø steps from 8.0 to 9.8 Fr., viewing angle 12°, instrument channel 1 x 5 Fr. or 2 x 3 Fr.</i>
AA-007-046	430mm	MARBERGER halbstarres Uretero-Renoskop mit 45° abgewinkeltem Okular, Ø stufenförmig von 8.0 bis 9.8 Charr., Blickwinkel 12°, Arbeitskanal 1 x 5 Charr. oder 2 x 3 Charr. <i>MARBERGER semirigid uretero-renaloscope with 45° angled ocular, Ø steps from 8.0 to 9.8 Fr., viewing angle 12°, instrument channel 1 x 5 Fr. or 2 x 3 Fr.</i>
AA-007-049	310mm	MARBERGER halbstarres Uretero-Renoskop mit 45° abgewinkeltem Okular, Ø stufenförmig von 8.5 bis 11.5 Charr., Blickwinkel 12°, Arbeitskanal 1 x 6 Charr. oder 2 x 4 Charr. <i>MARBERGER semirigid uretero-renaloscope with 45° angled ocular, Ø steps from 8.5 to 11.5 Fr., viewing angle 12°, instrument channel 1 x 6 Fr. or 2 x 4 Fr.</i>
AA-007-050	430mm	MARBERGER halbstarres Uretero-Renoskop mit 45° abgewinkeltem Okular, Ø stufenförmig von 8.5 bis 11.5 Charr., Blickwinkel 12°, Arbeitskanal 1 x 6 Charr. oder 2 x 4 Charr. <i>MARBERGER semirigid uretero-renaloscope with 45° angled ocular, Ø steps from 8.5 to 11.5 Fr., viewing angle 12°, instrument channel 1 x 6 Fr. or 2 x 4 Fr.</i>

STEMA High Definition



Bestell-Nr. Ordering no.	Arbeitslänge Working length	
AA-007-003	425mm	HD Halbstarres Uretero-Renoskop mit 45° abgewinkeltem Okular, Ø stufenförmig 7.5 bis 12 Charr., Blickwinkel 0° , Arbeitskanal 1 x 5 Charr. oder 2 x 3 Charr., 40.000 Pixel <i>HD Semirigid uretero-rensoscope with 45° angled ocular, Ø steps by 7.5 to 12 Fr., viewing angle 0°, working channel 1 x 5 Fr. or 2 x 3 Fr., 40.000 pixel</i>
AA-007-016	425mm	HD Halbstarres Uretero-Renoskop mit 45° abgewinkeltem Okular, Ø stufenförmig 7.5 bis 12 Charr., Blickwinkel 5° , Arbeitskanal 1 x 5 Charr. oder 2 x 3 Charr., 40.000 Pixel <i>HD Semirigid uretero-rensoscope with 45° angled ocular, Ø steps by 7.5 to 12 Fr., viewing angle 5°, working channel 1 x 5 Fr. or 2 x 3 Fr., 40.000 pixel</i>
AA-007-017	425mm	HD Halbstarres Uretero-Renoskop mit 45° abgewinkeltem Okular, Ø stufenförmig 7.5 bis 12 Charr., Blickwinkel 12° , Arbeitskanal 1 x 5 Charr. oder 2 x 3 Charr., 40.000 Pixel <i>HD Semirigid uretero-rensoscope with 45° angled ocular, Ø steps by 7.5 to 12 Fr., viewing angle 12°, working channel 1 x 5 Fr. or 2 x 3 Fr., 40.000 pixel</i>
AA-007-004	310mm	HD Halbstarres Uretero-Renoskop mit 45° abgewinkeltem Okular, Ø stufenförmig 7.5 bis 12 Charr., Blickwinkel 0° , Arbeitskanal 1 x 5 Charr. oder 2 x 3 Charr., 40.000 Pixel <i>HD Semirigid uretero-rensoscope with 45° angled ocular, Ø steps by 7.5 to 12 Fr., viewing angle 0°, working channel 1 x 5 Fr. or 2 x 3 Fr., 40.000 pixel</i>
AA-007-018	310mm	HD Halbstarres Uretero-Renoskop mit 45° abgewinkeltem Okular, Ø stufenförmig 7.5 bis 12 Charr., Blickwinkel 5° , Arbeitskanal 1 x 5 Charr. oder 2 x 3 Charr., 40.000 Pixel <i>HD Semirigid uretero-rensoscope with 45° angled ocular, Ø steps by 7.5 to 12 Fr., viewing angle 5°, working channel 1 x 5 Fr. or 2 x 3 Fr., 40.000 pixel</i>
AA-007-019	310mm	HD Halbstarres Uretero-Renoskop mit 45° abgewinkeltem Okular, Ø stufenförmig 7.5 bis 12 Charr., Blickwinkel 12° , Arbeitskanal 1 x 5 Charr. oder 2 x 3 Charr., 40.000 Pixel <i>HD Semirigid uretero-rensoscope with 45° angled ocular, Ø steps by 7.5 to 12 Fr., viewing angle 12°, working channel 1 x 5 Fr. or 2 x 3 Fr., 40.000 pixel</i>
AA-007-005	150mm	HD Halbstarres Uretero-Renoskop mit 45° abgewinkeltem Okular, Ø stufenförmig 7.5 bis 12 Charr., Blickwinkel 0° , Arbeitskanal 1 x 5 Charr. oder 2 x 3 Charr., 40.000 Pixel <i>HD Semirigid uretero-rensoscope with 45° angled ocular, Ø steps by 7.5 to 12 Fr., viewing angle 0°, working channel 1 x 5 Fr. or 2 x 3 Fr., 40.000 pixel</i>
AA-007-036	150mm	HD Halbstarres Uretero-Renoskop mit 45° abgewinkeltem Okular, Ø stufenförmig 7.5 bis 12 Charr., Blickwinkel 5° , Arbeitskanal 1 x 5 Charr. oder 2 x 3 Charr., 40.000 Pixel <i>HD Semirigid uretero-rensoscope with 45° angled ocular, Ø steps by 7.5 to 12 Fr., viewing angle 5°, working channel 1 x 5 Fr. or 2 x 3 Fr., 40.000 pixel</i>
AA-007-037	150mm	HD Halbstarres Uretero-Renoskop mit 45° abgewinkeltem Okular, Ø stufenförmig 7.5 bis 12 Charr., Blickwinkel 12° , Arbeitskanal 1 x 5 Charr. oder 2 x 3 Charr., 40.000 Pixel <i>HD Semirigid uretero-rensoscope with 45° angled ocular, Ø steps by 7.5 to 12 Fr., viewing angle 12°, working channel 1 x 5 Fr. or 2 x 3 Fr., 40.000 pixel</i>

Im Lieferumfang enthalten
Delivery contains

HD Uretero-Renoskop, Bürste Ø 3.0mm (Länge 590mm), Bürste Ø 3.8mm (Länge 350mm), Dichtungskappe Silikon (grau), Duckbill Dichtung
HD uretero-rensoscope, brush Ø 3.0mm (length 590mm), brush Ø 3.8mm (length 350mm), sealing cap silicone (grey), Duckbill sealing

STEMA High Definition



Bestell-Nr. Ordering no.	Arbeitslänge Working length	
AA-007-015	425mm	HD Halbstarres Uretero-Renoskop mit 45° abgewinkeltem Okular, Ø stufenförmig 6 bis 7.5 Charr., Blickwinkel 0° , Arbeitskanal 1 x 4 Charr. oder 2 x 2.4 Charr., 17.000 Pixel <i>HD Semirigid uretero-renaloscope with 45° angled ocular, Ø steps by 6 to 7.5 Fr., viewing angle 0°, working channel 1 x 4 Fr. or 2 x 2.4 Fr., 17.000 pixel</i>
AA-007-034	425mm	HD Halbstarres Uretero-Renoskop mit 45° abgewinkeltem Okular, Ø stufenförmig 6 bis 7.5 Charr., Blickwinkel 5° , Arbeitskanal 1 x 4 Charr. oder 2 x 2.4 Charr., 17.000 Pixel <i>HD Semirigid uretero-renaloscope with 45° angled ocular, Ø steps by 6 to 7.5 Fr., viewing angle 5°, working channel 1 x 4 Fr. or 2 x 2.4 Fr., 17.000 pixel</i>
AA-007-035	425mm	HD Halbstarres Uretero-Renoskop mit 45° abgewinkeltem Okular, Ø stufenförmig 6 bis 7.5 Charr., Blickwinkel 12° , Arbeitskanal 1 x 4 Charr. oder 2 x 2.4 Charr., 17.000 Pixel <i>HD Semirigid uretero-renaloscope with 45° angled ocular, Ø steps by 6 to 7.5 Fr., viewing angle 12°, working channel 1 x 4 Fr. or 2 x 2.4 Fr., 17.000 pixel</i>
AA-007-014	310mm	HD Halbstarres Uretero-Renoskop mit 45° abgewinkeltem Okular, Ø stufenförmig 6 bis 7.5 Charr., Blickwinkel 0° , Arbeitskanal 1 x 4 Charr. oder 2 x 2.4 Charr., 17.000 Pixel <i>HD Semirigid uretero-renaloscope with 45° angled ocular, Ø steps by 6 to 7.5 Fr., viewing angle 0°, working channel 1 x 4 Fr. or 2 x 2.4 Fr., 17.000 pixel</i>
AA-007-032	310mm	HD Halbstarres Uretero-Renoskop mit 45° abgewinkeltem Okular, Ø stufenförmig 6 bis 7.5 Charr., Blickwinkel 5° , Arbeitskanal 1 x 4 Charr. oder 2 x 2.4 Charr., 17.000 Pixel <i>HD Semirigid uretero-renaloscope with 45° angled ocular, Ø steps by 6 to 7.5 Fr., viewing angle 5°, working channel 1 x 4 Fr. or 2 x 2.4 Fr., 17.000 pixel</i>
AA-007-033	310mm	HD Halbstarres Uretero-Renoskop mit 45° abgewinkeltem Okular, Ø stufenförmig 6 bis 7.5 Charr., Blickwinkel 12° , Arbeitskanal 1 x 4 Charr. oder 2 x 2.4 Charr., 17.000 Pixel <i>HD Semirigid uretero-renaloscope with 45° angled ocular, Ø steps by 6 to 7.5 Fr., viewing angle 12°, working channel 1 x 4 Fr. or 2 x 2.4 Fr., 17.000 pixel</i>
AA-007-013	140mm	HD Halbstarres Uretero-Renoskop mit 45° abgewinkeltem Okular, Ø stufenförmig 6 bis 7.5 Charr., Blickwinkel 0° , Arbeitskanal 1 x 4 Charr. oder 2 x 2.4 Charr., 17.000 Pixel <i>HD Semirigid uretero-renaloscope with 45° angled ocular, Ø steps by 6 to 7.5 Fr., viewing angle 0°, working channel 1 x 4 Fr. or 2 x 2.4 Fr., 17.000 pixel</i>
AA-007-030	140mm	HD Halbstarres Uretero-Renoskop mit 45° abgewinkeltem Okular, Ø stufenförmig 6 bis 7.5 Charr., Blickwinkel 5° , Arbeitskanal 1 x 4 Charr. oder 2 x 2.4 Charr., 17.000 Pixel <i>HD Semirigid uretero-renaloscope with 45° angled ocular, Ø steps by 6 to 7.5 Fr., viewing angle 5°, working channel 1 x 4 Fr. or 2 x 2.4 Fr., 17.000 pixel</i>
AA-007-031	140mm	HD Halbstarres Uretero-Renoskop mit 45° abgewinkeltem Okular, Ø stufenförmig 6 bis 7.5 Charr., Blickwinkel 12° , Arbeitskanal 1 x 4 Charr. oder 2 x 2.4 Charr., 17.000 Pixel <i>HD Semirigid uretero-renaloscope with 45° angled ocular, Ø steps by 6 to 7.5 Fr., viewing angle 12°, working channel 1 x 4 Fr. or 2 x 2.4 Fr., 17.000 pixel</i>

Im Lieferumfang enthalten
Delivery contains

HD Uretero-Renoskop, Bürste Ø 3.0mm (Länge 590mm), Bürste Ø 3.8mm (Länge 350mm), Dichtungskappe Silikon (grau), Duckbill Dichtung
HD uretero-renaloscope, brush Ø 3.0mm (length 590mm), brush Ø 3.8mm (length 350mm), sealing cap silicone (grey), Duckbill sealing

STEMA High Definition



Bestell-Nr. Ordering no.	Arbeitslänge Working length	
AA-007-006	425mm	HD Halbstarres Uretero-Renoskop mit 45° abgewinkeltem Okular, Ø stufenförmig 4.9 bis 6.5 Charr., Blickwinkel 0° , Arbeitskanal 1 x 3 Charr., 17.000 Pixel <i>HD Semirigid uretero-rensoscope with 45° angled ocular, Ø steps by 4.9 to 6.5 Fr., viewing angle 0°, working channel 1 x 3 Fr., 17.000 pixel</i>
AA-007-022	425mm	HD Halbstarres Uretero-Renoskop mit 45° abgewinkeltem Okular, Ø stufenförmig 4.9 bis 6.5 Charr., Blickwinkel 5° , Arbeitskanal 1 x 3 Charr., 17.000 Pixel <i>HD Semirigid uretero-rensoscope with 45° angled ocular, Ø steps by 4.9 to 6.5 Fr., viewing angle 5°, working channel 1 x 3 Fr., 17.000 pixel</i>
AA-007-023	425mm	HD Halbstarres Uretero-Renoskop mit 45° abgewinkeltem Okular, Ø stufenförmig 4.9 bis 6.5 Charr., Blickwinkel 12° , Arbeitskanal 1 x 3 Charr., 17.000 Pixel <i>HD Semirigid uretero-rensoscope with 45° angled ocular, Ø steps by 4.9 to 6.5 Fr., viewing angle 12°, working channel 1 x 3 Fr., 17.000 pixel</i>
AA-007-007	310mm	HD Halbstarres Uretero-Renoskop mit 45° abgewinkeltem Okular, Ø stufenförmig 4.9 bis 6.5 Charr., Blickwinkel 0° , Arbeitskanal 1 x 3 Charr., 17.000 Pixel <i>HD Semirigid uretero-rensoscope with 45° angled ocular, Ø steps by 4.9 to 6.5 Fr., viewing angle 0°, working channel 1 x 3 Fr., 40.000 pixel</i>
AA-007-024	310mm	HD Halbstarres Uretero-Renoskop mit 45° abgewinkeltem Okular, Ø stufenförmig 4.9 bis 6.5 Charr., Blickwinkel 5° , Arbeitskanal 1 x 3 Charr., 17.000 Pixel <i>HD Semirigid uretero-rensoscope with 45° angled ocular, Ø steps by 4.9 to 6.5 Fr., viewing angle 5°, working channel 1 x 3 Fr., 17.000 pixel</i>
AA-007-025	310mm	HD Halbstarres Uretero-Renoskop mit 45° abgewinkeltem Okular, Ø stufenförmig 4.9 bis 6.5 Charr., Blickwinkel 12° , Arbeitskanal 1 x 3 Charr., 17.000 Pixel <i>HD Semirigid uretero-rensoscope with 45° angled ocular, Ø steps by 4.9 to 6.5 Fr., viewing angle 12°, working channel 1 x 3 Fr., 17.000 pixel</i>
AA-007-008	150mm	HD Halbstarres Uretero-Renoskop mit 45° abgewinkeltem Okular, Ø stufenförmig 4.9 bis 6.5 Charr., Blickwinkel 0° , Arbeitskanal 1 x 3 Charr., 17.000 Pixel <i>HD Semirigid uretero-rensoscope with 45° angled ocular, Ø steps by 4.9 to 6.5 Fr., viewing angle 0°, working channel 1 x 3 Fr., 17.000 pixel</i>
AA-007-026	150mm	HD Halbstarres Uretero-Renoskop mit 45° abgewinkeltem Okular, Ø stufenförmig 4.9 bis 6.5 Charr., Blickwinkel 5° , Arbeitskanal 1 x 3 Charr., 17.000 Pixel <i>HD Semirigid uretero-rensoscope with 45° angled ocular, Ø steps by 4.9 to 6.5 Fr., viewing angle 5°, working channel 1 x 3 Fr., 17.000 pixel</i>
AA-007-027	150mm	HD Halbstarres Uretero-Renoskop mit 45° abgewinkeltem Okular, Ø stufenförmig 4.9 bis 6.5 Charr., Blickwinkel 12° , Arbeitskanal 1 x 3 Charr., 17.000 Pixel <i>HD Semirigid uretero-rensoscope with 45° angled ocular, Ø steps by 4.9 to 6.5 Fr., viewing angle 12°, working channel 1 x 3 Fr., 17.000 pixel</i>

Im Lieferumfang enthalten Delivery contains

HD Uretero-Renoskop, Bürste Ø 3.0mm (Länge 590mm), Bürste Ø 3.8mm (Länge 350mm), Dichtungskappe Silikon (grau), Duckbill Dichtung
HD uretero-rensoscope, brush Ø 3.0mm (length 590mm), brush Ø 3.8mm (length 350mm), sealing cap silicone (grey), Duckbill sealing

STEMA High Definition



Bestell-Nr. Ordering no.	Arbeitslänge Working length	
AA-007-009	425mm	HD Halbstarres Uretero-Renoskop mit 45° abgewinkeltem Okular, Ø stufenförmig 7.5 bis 13.2 Charr., Blickwinkel 0° , Arbeitskanal 1 x 5 Charr. oder 2 x 3 Charr., 40.000 Pixel <i>HD Semirigid uretero-rensoscope with 45° angled ocular, Ø steps by 7.5 to 13.2 Fr., viewing angle 0°, working channel 1 x 5 Fr. or 2 x 3 Fr., 40.000 pixel</i>
AA-007-028	425mm	HD Halbstarres Uretero-Renoskop mit 45° abgewinkeltem Okular, Ø stufenförmig 7.5 bis 13.2 Charr., Blickwinkel 5° , Arbeitskanal 1 x 5 Charr. oder 2 x 3 Charr., 40.000 Pixel <i>HD Semirigid uretero-rensoscope with 45° angled ocular, Ø steps by 7.5 to 13.2 Fr., viewing angle 5°, working channel 1 x 5 Fr. or 2 x 3 Fr., 40.000 pixel</i>
AA-007-029	425mm	HD Halbstarres Uretero-Renoskop mit 45° abgewinkeltem Okular, Ø stufenförmig 7.5 bis 13.2 Charr., Blickwinkel 12° , Arbeitskanal 1 x 5 Charr. oder 2 x 3 Charr., 40.000 Pixel <i>HD Semirigid uretero-rensoscope with 45° angled ocular, Ø steps by 7.5 to 13.2 Fr., viewing angle 12°, working channel 1 x 5 Fr. or 2 x 3 Fr., 40.000 pixel</i>

Im Lieferumfang enthalten
Delivery contains

HD Uretero-Renoskop, Bürste Ø 3.0mm (Länge 590mm), Bürste Ø 3.8mm (Länge 350mm), Dichtungskappe Silikon (grau), Duckbill Dichtung
HD uretero-rensoscope, brush Ø 3.0mm (length 590mm), brush Ø 3.8mm (length 350mm), sealing cap silicone (grey), Duckbill sealing

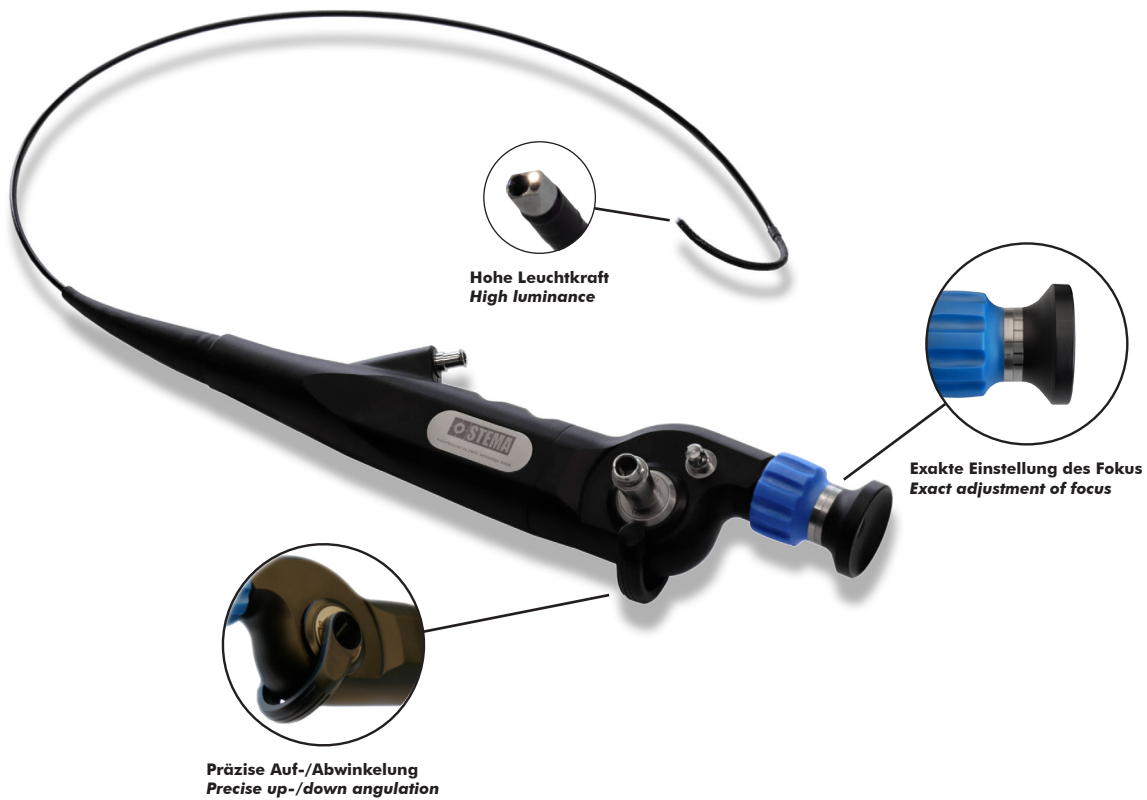

Bestell-Nr.
Ordering no.

AA-008-003

Flexibles Uretero-Renoskop FLEX II
Flexible uretero-roscope FLEX II

Einführschlauch / Insertion tube Ø 2.8mm / Ø 2.8mm
 Arbeitskanal / Working channel Ø 1.2mm / Ø 1.2mm
 Nutzlänge / Working length 680mm / 680mm
 Blickwinkel / Field of view 88° / 88°
 Abwinkelung auf-ab / Angulation up-down 275° / 275°
 Zubehör / Accessories Absaugventil, Dichtigkeitstester / Suction valve, leak tester

Im Lieferumfang enthalten
Deliver contains

Flexibles Uretero-Renoskop FLEX II, Absaugventil, Dichtigkeitstester
 Flexible uretero-roscope FLEX II, suction valve, leak tester









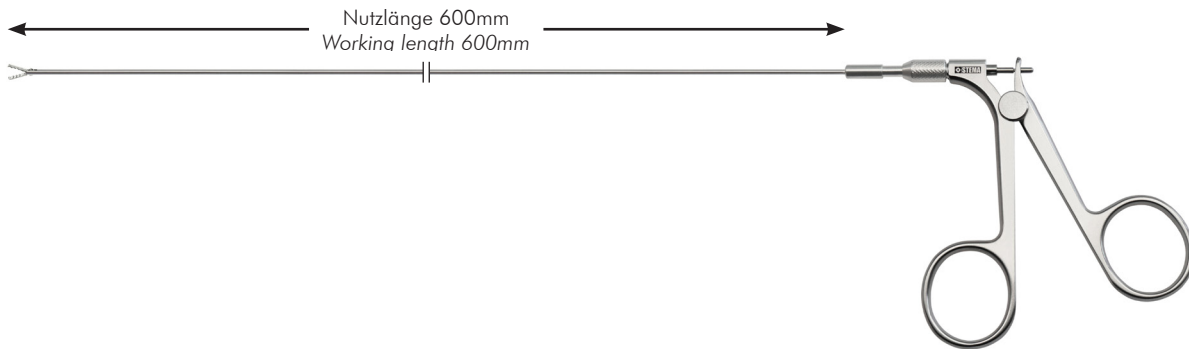





Absaugventil (im Lieferumfang enthalten)
Suction valve (included in scope of delivery)





Dichtigkeitstester (im Lieferumfang enthalten)
Leak tester (included in scope of delivery)

	Bestell-Nr. Ordering no.	
	AA-008-100	Hahnbrücke mit Luer-Lock und 2 Hähnen für AA-008-002 <i>Bridge with Luer-Lock and 2 stop cocks for AA-008-002</i>
	AA-008-102	Koffer grau für STEMA flexible Optiken <i>Suitcase grey for STEMA flexible scopes</i>
	AA-008-103	Dichtigkeitstester <i>Leak tester</i>
	AA-008-104	Einweg Luer-Lock Adapter, 25 St./Box <i>Single use Luer-Lock adapter, 25 pcs./box</i>
	AA-008-105	Absaugventil <i>Suction valve</i>

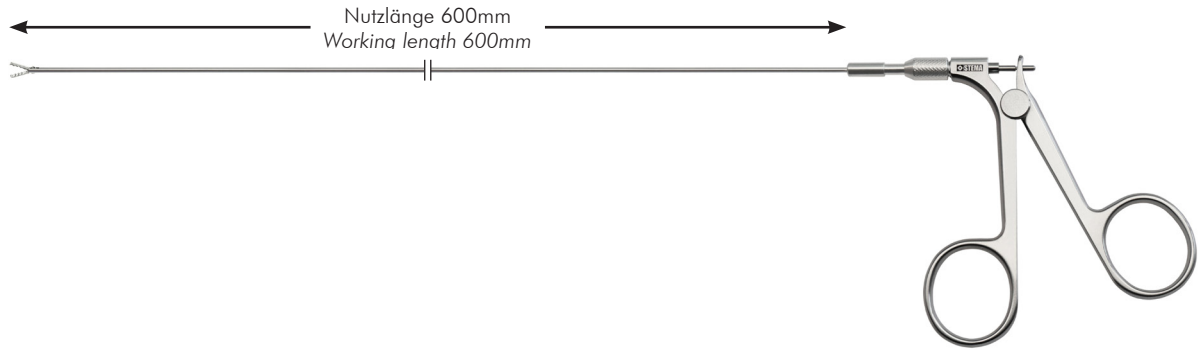

		Ømm	Charr. Fr.	Flexibel Flexible	Halbstarr Semi-rigid	Starr Rigid
 Probeexzisionszange oval, doppelbeweglich <i>Biopsy forceps oval, double action</i>		1.0	3	AC-001-011	AC-001-211	AC-001-011-R
		1.6	5	AC-001-012	AC-001-212	AC-001-012-R
		2.1	6	AC-001-013	AC-001-213	AC-001-013-R
		2.3	7	AC-001-014	AC-001-214	AC-001-014-R
		3.0	9	AC-001-015	AC-001-215	AC-001-015-R
 Probeexzisionszange oval, gezahnt, doppelbeweglich <i>Biopsy forceps oval, serrated, double action</i>		1.0	3	AC-002-011	AC-002-211	AC-002-011-R
		1.6	5	AC-002-012	AC-002-212	AC-002-012-R
		2.1	6	AC-002-013	AC-002-213	AC-002-013-R
		2.3	7	AC-002-014	AC-002-214	AC-002-014-R
		3.0	9	AC-002-015	AC-002-215	AC-002-015-R
 Probeexzisionszange oval, gezahnt, Zähne ineinandergreifend, doppelbeweglich <i>Biopsy forceps oval, serrated, teeth interlock, double action</i>		1.6	5	AC-015-012	AC-015-212	AC-015-012-R
		2.1	6		AC-015-213	AC-015-013-R
		2.3	7	AC-015-014	AC-015-214	AC-015-014-R
 Fremdkörperzange, doppelbeweglich <i>Grasping forceps for stone street, double action</i>		1.2	4	AC-017-011	AC-017-211	AC-017-011-R
		2.3	7	AC-017-014	AC-017-214	AC-017-014-R
 Fasszange Alligatormaul, doppelbeweglich <i>Grasping forceps alligator jaw, double action</i>		1.0	3	AC-006-011	AC-006-211	AC-006-011-R
		1.2	4	AC-006-013	AC-006-213	AC-006-013-R
		1.6	5	AC-006-012	AC-006-212	AC-006-012-R
		2.3	7	AC-006-014	AC-006-214	AC-006-014-R
		3.0	9	AC-006-015	AC-006-215	AC-006-015-R
 Fasszange DJ, doppelbeweglich <i>Grasping forceps DJ, double action</i>		2.3	7	AC-008-014	AC-008-214	AC-008-014-R
		3.0	9	AC-008-015	AC-008-215	AC-008-015-R
 Fasszange gezahnt, doppelbeweglich <i>Grasping forceps teeth, double action</i>		1.2	4	AC-016-011	AC-016-211	AC-016-011-R
		1.6	5	AC-016-012	AC-016-212	AC-016-012-R
 Fasszange Zähne ineinander, doppelbeweglich <i>Grasping forceps teeth interlock, double action</i>		1.6	5	AC-020-012	AC-020-212	AC-020-012-R
		2.3	7	AC-020-014	AC-020-214	AC-020-014-R
 Fasszange Rattenzahn, doppelbeweglich <i>Grasping forceps rat tooth, double action</i>		1.0	3	AC-019-011	AC-019-211	AC-019-011-R
		1.6	5	AC-019-012	AC-019-212	AC-019-012-R
 Fasszange für Steinstrasse, doppelbeweglich <i>Grasping forceps for stone street, double action</i>		1.2	4	AC-007-011	AC-007-211	AC-007-011-R
		1.6	5	AC-007-012	AC-007-212	AC-007-012-R
 Fasszange für große Steine, doppelbeweglich <i>Grasping forceps for big stones, double action</i>		1.2	4	AC-009-011	AC-009-211	AC-009-011-R
		1.6	5	AC-009-012	AC-009-212	AC-009-012-R
		2.3	7	AC-009-014	AC-009-214	AC-009-014-R
 Dreiarmergreifer 3-Prongs retrieve		1.0	3	AC-012-011		
		1.6	5	AC-012-012		
		2.3	7	AC-012-014		





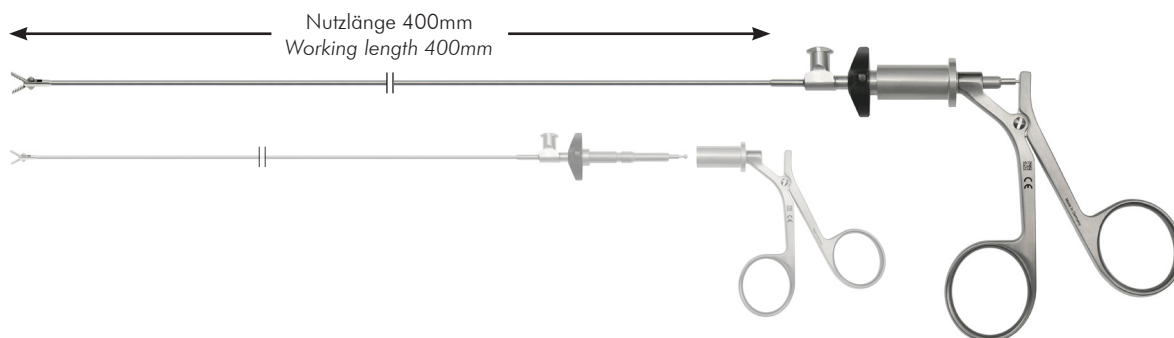



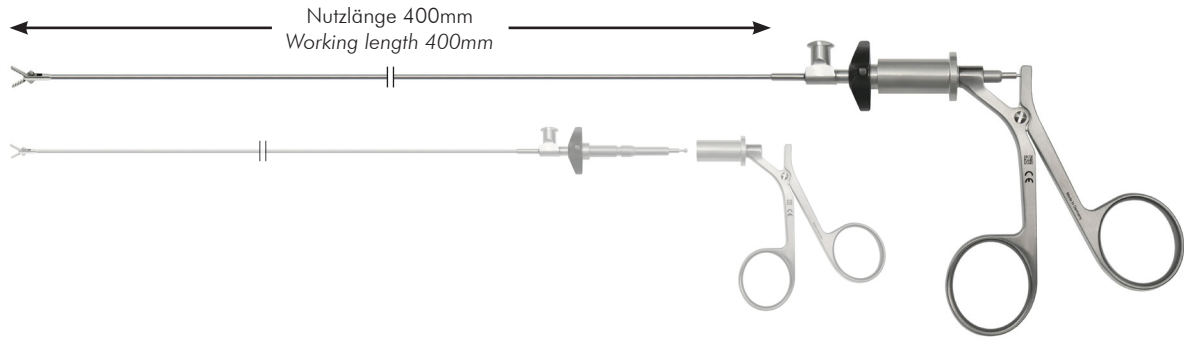

		Ømm	Charr. Fr.	Flexibel Flexible	Halbstarr Semi-rigid	Starr Rigid
	Schere gezahnt, doppelbeweglich Scissors serrated, double action	2.3	7	AC-005-014	AC-005-214	AC-005-014-R
	Schere, einfachbeweglich Scissors, single action	1.0	3	AC-003-011	AC-003-211	AC-003-011-R
		1.2	4	AC-003-010	AC-003-210	AC-003-010-R
		1.6	5	AC-003-012	AC-003-212	AC-003-012-R
		2.1	6	AC-003-013	AC-003-213	AC-003-013-R
		2.3	7	AC-003-014	AC-003-214	AC-003-014-R
	Ureter-Schlitzschere, einfachbeweglich Uretero slitting scissors, single action	3.0	9	AC-003-015	AC-003-215	AC-003-015-R
		1.2	4		AC-018-211	AC-018-011-R
	Hakenschere, einfachbeweglich Hook scissors, single action	1.6	5		AC-018-212	AC-018-012-R
		2.3	7	AC-004-014	AC-004-214	AC-004-014-R
		3.0	9	AC-004-015	AC-004-215	AC-004-015-R









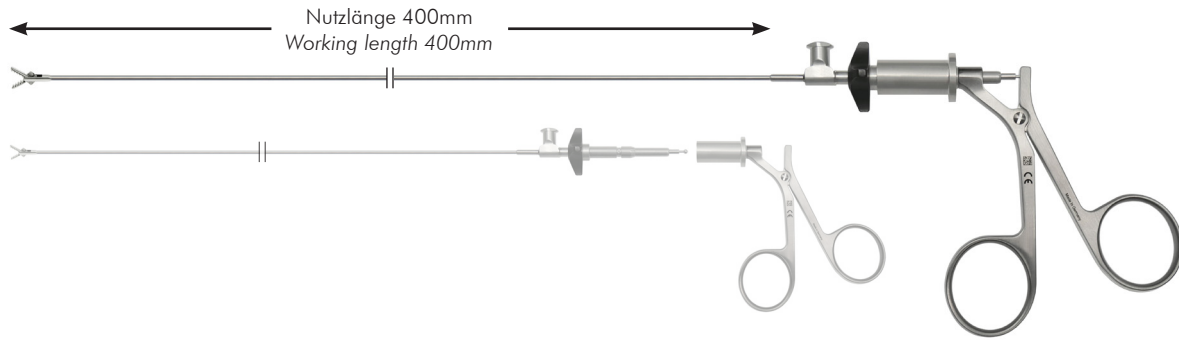

		Ømm	Charr. Fr.	Komplett Complete	Einsatz Insert	Griff Handle
	Probeexzisionszange oval, doppelbeweglich <i>Biopsy forceps oval, double action</i>	1.0	3	AC-001-011-T	AC-001-011-OT	AC-100-001
		1.2	4	AC-001-010-T	AC-001-010-OT	
		1.6	5	AC-001-012-T	AC-001-012-OT	
		2.3	7	AC-001-014-T	AC-001-014-OT	
		3.0	9	AC-001-015-T	AC-001-015-OT	
	Probeexzisionszange oval, gezahnt, doppelbeweglich <i>Biopsy forceps oval, serrated, double action</i>	1.2	4	AC-016-011-T	AC-016-011-OT	AC-100-001
		1.6	5	AC-016-012-T	AC-016-012-OT	
	Fasszange Alligatormaul, doppelbeweglich <i>Grasping forceps alligator jaw, double action</i>	1.0	3	AC-006-011-T	AC-006-011-OT	AC-100-001
		1.2	4	AC-006-013-T	AC-006-013-OT	
		1.6	5	AC-006-012-T	AC-006-012-OT	
		2.3	7	AC-006-014-T	AC-006-014-OT	
		3.0	9	AC-006-015-T	AC-006-015-OT	
	Fasszange für Steinstrasse, doppelbeweglich <i>Grasping forceps for stone street, double action</i>	1.2	4	AC-007-011-T	AC-007-011-OT	AC-100-001
		1.6	5	AC-007-012-T	AC-007-012-OT	
	Fasszange für große Steine, doppelbeweglich <i>Grasping forceps for big stones, double action</i>	1.2	4	AC-009-011-T	AC-009-011-OT	AC-100-001
		1.6	5	AC-009-012-T	AC-009-012-OT	
	Schere, einfachbeweglich <i>Scissors, single action</i>	1.0	3	AC-003-010-T	AC-003-010-OT	AC-100-001
		1.2	4	AC-003-011-T	AC-003-011-OT	
		1.6	5	AC-003-012-T	AC-003-012-OT	
		2.3	7	AC-003-014-T	AC-003-014-OT	
		3.0	9	AC-003-015-T	AC-003-015-OT	
	Schere spitz, einfachbeweglich <i>Scissors pointed, single action</i>	1.6	5	AC-003-412-T	AC-003-412-OT	AC-100-001
	Hakenschere, einfachbeweglich <i>Hook scissors, single action</i>	2.3	7	AC-004-014-T	AC-004-014-OT	AC-100-001
		3.0	9	AC-004-015-T	AC-004-015-OT	
	Biopsiestanze, einfachbeweglich <i>Biopsy punch forceps, single action</i>	1.6	5	AC-014-012-T	AC-014-012-OT	AC-100-001



	Ømm	Charr. Fr.	Komplett Complete	Einsatz Insert	Griff Handle
 Probeexzisionszange oval, doppelbeweglich <i>Biopsy forceps oval, double action</i>	1.0	3	AC-001-211-T	AC-001-211-OT	AC-100-001
	1.2	4	AC-001-210-T	AC-001-210-OT	
	1.6	5	AC-001-212-T	AC-001-212-OT	
	2.3	7	AC-001-214-T	AC-001-214-OT	
	3.0	9	AC-001-215-T	AC-001-215-OT	
 Probeexzisionszange oval, gezahnt, doppelbeweglich <i>Biopsy forceps oval, serrated, double action</i>	1.2	4	AC-016-211-T	AC-016-211-OT	AC-100-001
	1.6	5	AC-016-212-T	AC-016-212-OT	
 Fasszange Alligatormaul, doppelbeweglich <i>Grasping forceps alligator jaw, double action</i>	1.0	3	AC-006-211-T	AC-006-211-OT	AC-100-001
	1.2	4	AC-006-213-T	AC-006-213-OT	
	1.6	5	AC-006-212-T	AC-006-212-OT	
	2.3	7	AC-006-214-T	AC-006-214-OT	
	3.0	9	AC-006-215-T	AC-006-215-OT	
 Fasszange für Steinstrasse, doppelbeweglich <i>Grasping forceps for stone street, double action</i>	1.2	4	AC-007-211-T	AC-007-211-OT	AC-100-001
	1.6	5	AC-007-212-T	AC-007-212-OT	
 Fasszange für große Steine, doppelbeweglich <i>Grasping forceps for big stones, double action</i>	1.2	4	AC-009-211-T	AC-009-211-OT	AC-100-001
	1.6	5	AC-009-212-T	AC-009-212-OT	
 Schere, einfachbeweglich <i>Scissors, single action</i>	1.0	3	AC-003-210-T	AC-003-210-OT	AC-100-001
	1.2	4	AC-003-211-T	AC-003-211-OT	
	1.6	5	AC-003-212-T	AC-003-212-OT	
	2.3	7	AC-003-214-T	AC-003-214-OT	
	3.0	9	AC-003-215-T	AC-003-215-OT	
 Schere spitz, einfachbeweglich <i>Scissors pointed, single action</i>	1.6	5	AC-004-622-T	AC-004-622-OT	AC-100-001
	2.3	7	AC-004-624-T	AC-004-624-OT	
 Hakenschere, einfachbeweglich <i>Hook scissors, single action</i>	2.3	7	AC-004-214-T	AC-004-214-OT	AC-100-001
	3.0	9	AC-004-215-T	AC-004-215-OT	
 Biopsiestanze, einfachbeweglich <i>Biopsy punch forceps, single action</i>	1.6	5	AC-014-212-T	AC-014-212-OT	AC-100-001



		Ømm	Charr. Fr.	Komplett Complete	Einsatz Insert	Griff Handle
 Probeexzisionszange oval, doppelbeweglich <i>Biopsy forceps oval, double action</i>		1.0	3	AC-101-211-T	AC-101-211-OT	AC-100-001
		1.2	4	AC-101-210-T	AC-101-210-OT	
		1.6	5	AC-101-212-T	AC-101-212-OT	
		2.3	7	AC-101-214-T	AC-101-214-OT	
		3.0	9	AC-101-215-T	AC-101-215-OT	
 Probeexzisionszange oval, gezahnt, doppelbeweglich <i>Biopsy forceps oval, serrated, double action</i>		1.2	4	AC-116-211-T	AC-116-211-OT	AC-100-001
		1.6	5	AC-116-212-T	AC-116-212-OT	
 Fasszange Alligatormaul, doppelbeweglich <i>Grasping forceps alligator jaw, double action</i>		1.0	3	AC-106-211-T	AC-106-211-OT	AC-100-001
		1.2	4	AC-106-213-T	AC-106-213-OT	
		1.6	5	AC-106-212-T	AC-106-212-OT	
		2.3	7	AC-106-214-T	AC-106-214-OT	
 Fasszange für Steinstrasse, doppelbeweglich <i>Grasping forceps for stone street, double action</i>		1.2	4	AC-107-211-T	AC-107-211-OT	AC-100-001
		1.6	5	AC-107-212-T	AC-107-212-OT	
 Fasszange für große Steine, doppelbeweglich <i>Grasping forceps for big stones, double action</i>		1.2	4	AC-109-211-T	AC-109-211-OT	AC-100-001
		1.6	5	AC-109-212-T	AC-109-212-OT	
 Schere, einfachbeweglich <i>Scissors, single action</i>		1.0	3	AC-103-210-T	AC-103-210-OT	AC-100-001
		1.2	4	AC-103-211-T	AC-103-211-OT	
		1.6	5	AC-103-212-T	AC-103-212-OT	
		2.3	7	AC-103-214-T	AC-103-214-OT	
		3.0	9	AC-103-215-T	AC-103-215-OT	
 Schere spitz, einfachbeweglich <i>Scissors pointed, single action</i>		1.6	5	AC-104-622-T	AC-104-622-OT	AC-100-001
		2.3	7	AC-104-624-T	AC-104-624-OT	
 Hakenschere, einfachbeweglich <i>Hook scissors, single action</i>		2.3	7	AC-104-214-T	AC-104-214-OT	AC-100-001
		3.0	9	AC-104-215-T	AC-104-215-OT	
 Biopsiestanze, einfachbeweglich <i>Biopsy punch forceps, single action</i>		1.6	5	AC-114-212-T	AC-114-212-OT	AC-100-001



Bestell-Nr. Ordering no.	Drähte Wires	Charr. Fr.	
AF-001-021			Griff für Dormia Steinfänger 3 und 5 Charr. Handle for dormia stone extractor 3 and 5 Fr.
AF-001-001	4	3	Dormia Steinfänger, Körbchen mit Tubus , Arbeitslänge 60cm Dormia stone extractor, basket with tubus , working length 60cm
AF-001-002	4	3	Dormia Steinfänger komplett mit Griff, Arbeitslänge 60cm Dormia stone extractor complete with handle, working length 60cm
AF-001-015	4	3	Dormia Steinfänger, Körbchen mit Tubus , Arbeitslänge 90cm Dormia stone extractor, basket with tubus , working length 90cm
AF-001-016	4	3	Dormia Steinfänger komplett mit Griff, Arbeitslänge 90cm Dormia stone extractor complete with handle, working length 90cm
AF-001-003	4	5	Dormia Steinfänger, Körbchen mit Tubus , Arbeitslänge 60cm Dormia stone extractor, basket with tubus , working length 60cm
AF-001-004	4	5	Dormia Steinfänger komplett mit Griff, Arbeitslänge 60cm Dormia stone extractor complete with handle, working length 60cm
AF-001-007	5	5	Dormia Steinfänger, Körbchen mit Tubus , Arbeitslänge 60cm Dormia stone extractor, basket with tubus , working length 60cm
AF-001-008	5	5	Dormia Steinfänger komplett mit Griff, Arbeitslänge 60cm Dormia stone extractor complete with handle, working length 60cm
AF-001-011	6	5	Dormia Steinfänger, Körbchen mit Tubus , Arbeitslänge 60cm Dormia stone extractor, basket with tubus , working length 60cm
AF-001-017	4	5	Dormia Steinfänger, Körbchen mit Tubus , Arbeitslänge 90cm Dormia stone extractor, basket with tubus , working length 90cm
AF-001-019	4	5	Dormia Steinfänger komplett mit Griff, Arbeitslänge 90cm Dormia stone extractor complete with handle, working length 90cm
AF-001-025	5	5	Dormia Steinfänger, Körbchen mit Tubus , Arbeitslänge 90cm Dormia stone extractor, basket with tubus , working length 90cm
AF-001-018	5	5	Dormia Steinfänger komplett mit Griff, Arbeitslänge 90cm Dormia stone extractor complete with handle, working length 90cm



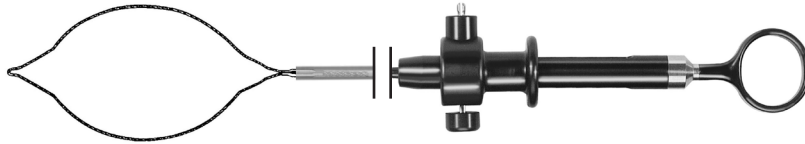









Bestell-Nr. Ordering no.	Drähte Wires	Charr. Fr.	
AF-001-024			Griff für Dormia Steinfänger 7 Charr. Handle for dormia stone extractor 7 Fr.
AF-001-005	4	7	Dormia Steinfänger, Körbchen mit Tubus , Arbeitslänge 60cm Dormia stone extractor, basket with tubus , working length 60cm
AF-001-006	4	7	Dormia Steinfänger komplett mit Griff, Arbeitslänge 60cm Dormia stone extractor complete with handle, working length 60cm
AF-001-009	5	7	Dormia Steinfänger, Körbchen mit Tubus , Arbeitslänge 60cm Dormia stone extractor, basket with tubus , working length 60cm
AF-001-010	5	7	Dormia Steinfänger komplett mit Griff, Arbeitslänge 60cm Dormia stone extractor complete with handle, working length 60cm
AF-001-013	6	7	Dormia Steinfänger, Körbchen mit Tubus , Arbeitslänge 60cm Dormia stone extractor, basket with tubus , working length 60cm
AF-001-014	6	7	Dormia Steinfänger komplett mit Griff, Arbeitslänge 60cm Dormia stone extractor complete with handle, working length 60cm



Bestell-Nr. Ordering no.	Charr. Fr.	
AF-002-002	5	Diathermie Schlinge komplett mit Griff, Arbeitslänge 60cm Diathermy loop complete with handle, working length 60cm
AF-002-001	5	Diathermie Schlinge, Schlinge mit Tubus , Arbeitslänge 60cm Diathermy loop, loop with tubus , working length 60cm
AF-002-004	7	Diathermie Schlinge komplett mit Griff, Arbeitslänge 60cm Diathermy loop complete with handle, working length 60cm
AF-002-003	7	Diathermie Schlinge, Schlinge mit Tubus , Arbeitslänge 60cm Diathermy loop, loop with tubus , working length 60cm
AF-002-010		Griff mit HF-Anschluss für Diathermie Schlingen Handle with HF connector for diathermy loops



	Bestell-Nr. Ordering no.	Länge Length	Bestell-Nr. Ordering no.	Länge Length	Charr. Fr.	
	AD-003-003	530mm	AD-003-013	650mm	5	Schlingen-Elektrode flexibel, monopolar. Loop electrode flexible, monopolar
	AD-003-005	530mm	AD-003-015	650mm	7	
	AD-003-007	530mm	AD-003-017	650mm	9	
	AD-003-008	530mm	AD-003-018	650mm	10	Nadel-Elektrode flexibel, monopolar Needle electrode flexible, monopolar
	AD-002-001	530mm	AD-002-011	650mm	3	
	AD-002-002	530mm	AD-002-012	650mm	4	
	AD-002-003	530mm	AD-002-013	650mm	5	Knopf-Elektrode flexibel, monopolar Button electrode flexible, monopolar
	AD-002-005	530mm	AD-002-015	650mm	7	
	AD-001-001	530mm	AD-001-011	650mm	3	
	AD-001-002	530mm	AD-001-012	650mm	4	
	AD-001-003	530mm	AD-001-013	650mm	5	
	AD-001-004	530mm	AD-001-014	650mm	6	
	AD-001-005	530mm	AD-001-015	650mm	7	
	AD-001-006	530mm	AD-001-016	650mm	8	
AD-001-007	530mm	AD-001-017	650mm	9		
AD-001-008	530mm	AD-001-018	650mm	10		

Anschluss Instrumentenseite <i>Connection instrument side</i>		Anschluss Geräteseite <i>Connection unit side</i>	
 		AD-010-001 / AD-010-006 	
		AD-010-002 / AD-010-007 	
		AD-010-003 / AD-010-008 	
		AD-010-004 / AD-010-005 	
		AD-010-024 	
 	AD-010-021		
	AD-010-022		
 	AD-010-023		
Alle Kabel (außer AD-010-023) passen zu den flexiblen Elektroden AD-001-001 bis AD-003-018 All cables (except AD-010-023) fit with the flexible electrodes AD-001-001 to AD-003-018			

Bestell-Nr. Ordering no.	Länge Length	
AD-010-001 AD-010-006	3m 5m	Monopolares Anschlusskabel für Berchtold, Martin, Aesculap , Ø 4mm <i>Monopolar connecting cable for Berchtold, Martin, Aesculap, Ø 4mm</i>
AD-010-002 AD-010-007	3m 5m	Monopolares Anschlusskabel für Erbe, ACC/ICC, Storz , Ø 5mm <i>Monopolar connecting cable for Erbe, ACC/ICC, Storz, Ø 5mm</i>
AD-010-003 AD-010-008	3m 5m	Monopolares Anschlusskabel für Valleylab/Comned , Ø 8mm <i>Monopolar connecting cable for Valleylab/Comned, Ø 8mm</i>
AD-010-004 AD-010-005	3m 5m	Monopolares Anschlusskabel für Geräte mit 4mm Bananenstecker <i>Monopolar connecting cable for units with 4mm banana plug</i>
AD-010-024	4.5m	Monopolares Anschlusskabel für STEMA MASTER Geräte <i>Monopolar connecting cable for STEMA MASTER units</i>
AD-010-021	4.5m	Monopolares Anschlusskabel für STEMA MASTER Geräte mit SDS-Erkennung für STEMA , Ø 2mm <i>Monopolar connecting cable for STEMA MASTER units with SDS identification for STEMA, Ø 2mm</i>
AD-010-022	4.5m	Monopolares Anschlusskabel für STEMA MASTER Geräte mit SDS-Erkennung für STORZ , 90° Anschluss <i>Monopolar connecting cable for STEMA MASTER units with SDS identification for STORZ, 90° connection</i>
AD-010-023	4.5m	Monopolares Anschlusskabel für STEMA MASTER Geräte mit SDS-Erkennung für Olympus , Ø 3mm <i>Monopolar connecting cable for STEMA MASTER units with SDS identification for Olympus, Ø 3mm</i>



**Bestell-Nr.
Ordering no.**

AA-002-001	Zystoskop Ø 4.0mm, Blickwinkel 0°, autoklavierbar <i>Cystoscope Ø 4.0mm, 0° viewing angle, autoclavable</i>
AA-002-003	Zystoskop Ø 4.0mm, Blickwinkel 30°, autoklavierbar <i>Cystoscope Ø 4.0mm, 30° viewing angle, autoclavable</i>
AA-002-011	HD Zystoskop Ø 4.0mm, Blickwinkel 0°, autoklavierbar HD <i>Cystoscope Ø 4.0mm, 0° viewing angle, autoclavable</i>
AA-002-013	HD Zystoskop Ø 4.0mm, Blickwinkel 30°, autoklavierbar HD <i>Cystoscope Ø 4.0mm, 30° viewing angle, autoclavable</i>



**Bestell-Nr.
Ordering no.** **Farbmarkierung
Colour code**

AB-002-010	Blau <i>Blue</i>	Lithotripsieschaft mit Zentralhahn zur Benutzung mit AB-004-011 <i>Lithotripsy sheath with central valve used for AB-004-011</i>
-------------------	---------------------	---



**Bestell-Nr.
Ordering no.** **Farbmarkierung
Colour code**

AB-002-013	Blau <i>Blue</i>	Lithotripsieschaft zur Benutzung mit AB-004-011 <i>Lithotripsy sheath used for AB-004-011</i>
-------------------	---------------------	--



**Bestell-Nr.
Ordering no.** **Farbmarkierung
Colour code**

AB-002-012	Blau <i>Blue</i>	Obturator für AB-002-013 <i>Obturator for AB-002-013</i>
-------------------	---------------------	---



**Bestell-Nr.
Ordering no.** **Farbmarkierung
Colour code**

AB-002-011	Blau <i>Blue</i>	Untersuchungseinsatz mit Arbeitskanal für flexible Instrumente 7 Charr. <i>Diagnostic sheath with with working channel for instruments 7 Fr.</i>
-------------------	---------------------	---

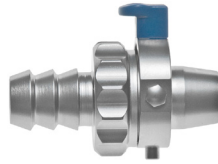

Bestell-Nr. Ordering no.	Farbmarkierung Colour code	
AB-002-014	Blau Blue	Adpator zur Benutzung des Ellik <i>Adaptor for use with Ellik</i>

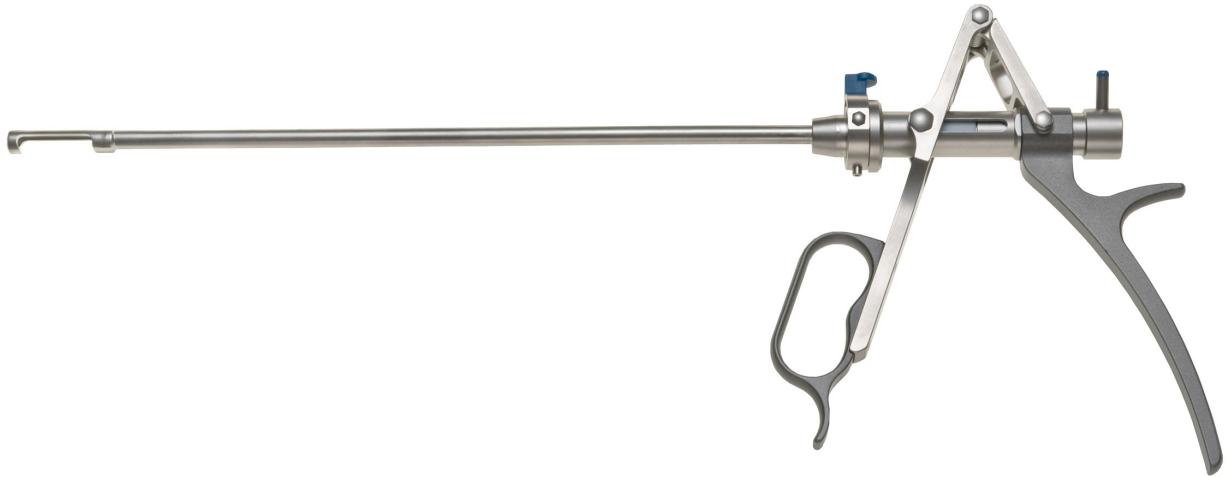

Bestell-Nr. Ordering no.		
AB-004-011	Arbeitselement zur Punch-Lithotripsie <i>Working element used for punch lithotripsy</i>	

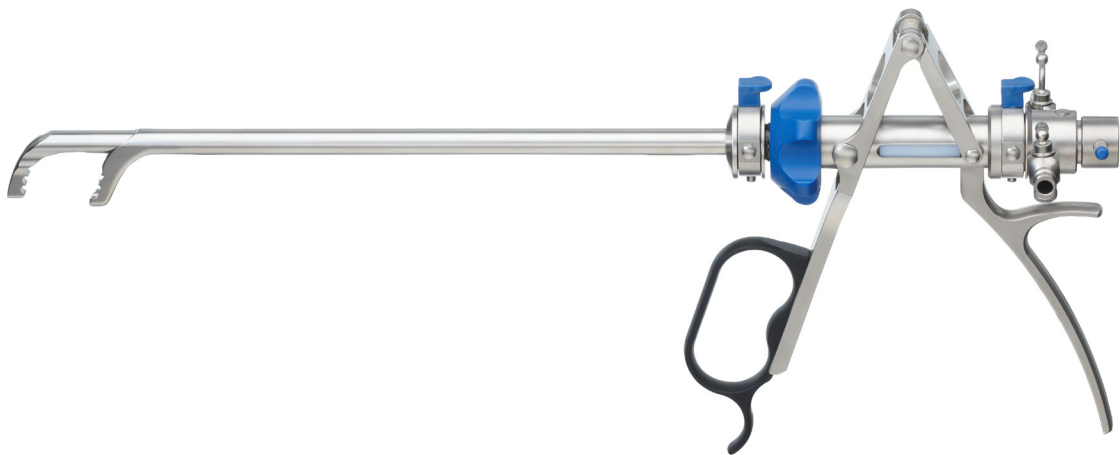

Bestell-Nr. Ordering no.		
AB-004-012	Mechanischer Lithotriptor mit Griff- und Schraubmechanismus, Ø 24 Charr., 2 Hähne mit Luer-Lock Adapter, zur Verwendung mit Optik AA-002-004 <i>Mechanical lithotripter with handle and turning screw, Ø 24 Fr., 2 stopcocks with luer lock adapter, for use with scope AA-002-004</i>	

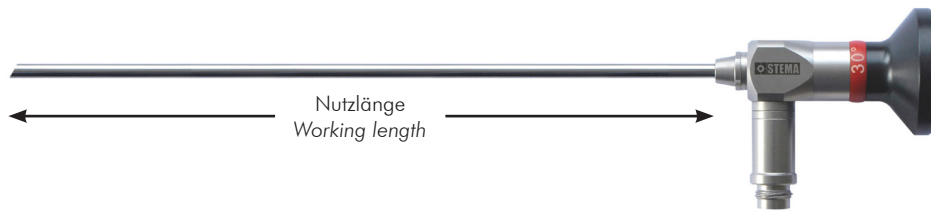

Bestell-Nr. Ordering no.	Durchmesser Diameter	Blickrichtung Direction of view	Farbmarkierung Colour code	Nutzlänge Working length
AA-004-013	1.9mm	0°	Grün Green	145mm
AA-004-014	1.9mm	30°	Rot Red	145mm
AA-004-011	2.0mm	0°	Grün Green	187mm
AA-004-012	2.0mm	30°	Rot Red	187mm
AA-004-001	2.0mm	0°	Grün Green	260mm
AA-004-002	2.0mm	30°	Rot Red	260mm
AA-005-001	2.7mm	0°	Grün Green	187.5mm
AA-005-003	2.7mm	30°	Rot Red	187.5mm
AA-005-004	2.7mm	70°	Gelb Yellow	187.5mm



Bestell-Nr.
Ordering no.

AA-004-013

Pädiatrie-Zystoskop Ø 1.9mm, Blickwinkel 0°, Arbeitslänge 145mm, autoklavierbar
Pediatric-Cystoscope Ø 1.9mm, 0° viewing angle, working length 145mm, autoclavable

AA-004-014

Pädiatrie-Zystoskop Ø 1.9mm, Blickwinkel 30°, Arbeitslänge 145mm, autoklavierbar
Pediatric-Cystoscope Ø 1.9mm, 30° viewing angle, working length 145mm, autoclavable

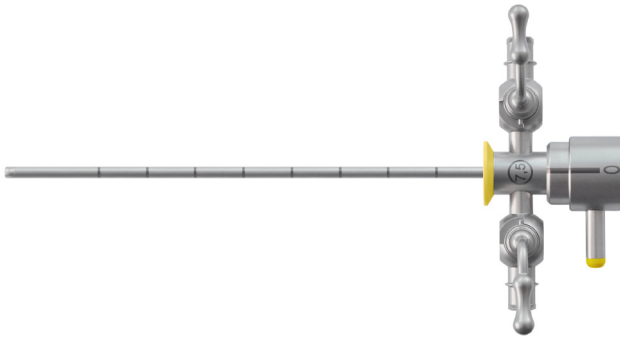

Bestell-Nr.
Ordering no.

AB-001-001-7

Gelb
Yellow

Farbmarkierung
Colour code

Zysto-Urethroskopschaft 7.5 Ch. mit 2 starren Hähnen
Cysto-Urethroscope sheath 7.5 Fr. with 2 fixed stopcocks



Bestell-Nr.
Ordering no.

AB-001-011-7

Gelb
Yellow

Farbmarkierung
Colour code

Standardobturator für Zysto-Urethroskopschäfte 7.5 Charr.
Standardobturator Cysto-Urethroscope sheath 7.5 Fr.



**Bestell-Nr.
Ordering no.**

AA-004-011	Pädiatrie-Zystoskop Ø 2.0mm, Blickwinkel 0°, Arbeitslänge 187mm, autoklavierbar <i>Pediatric-Cystoscope Ø 2.0mm, 0° viewing angle, working length 187mm, autoclavable</i>
AA-004-012	Pädiatrie-Zystoskop Ø 2.0mm, Blickwinkel 30°, Arbeitslänge 187mm, autoklavierbar <i>Pediatric-Cystoscope Ø 2.0mm, 30° viewing angle, working length 187mm, autoclavable</i>



**Bestell-Nr.
Ordering no.** **Farbmarkierung
Colour code**

AB-001-001-9	Blau <i>Blue</i>	Zysto-Urethroskopschaft 9.5 Ch. mit 2 starren Hähnen, 1 x 3 Ch. Instrumentenkanal, mit Obturator <i>Cysto-Urethroscope sheath 9.5 Fr. with 2 fixed stopcocks, 1 x 3 Fr. instrument channel, with obturator</i>
AB-001-001-11	Grün <i>Green</i>	Zysto-Urethroskopschaft 11 Ch. mit 2 starren Hähnen, 1 x 3 Ch. Instrumentenkanal, mit Obturator <i>Cysto-Urethroscope sheath 11 Fr. with 2 fixed stopcocks, 1 x 3 Fr. instrument channel, with obturator</i>



**Bestell-Nr.
Ordering no.** **Farbmarkierung
Colour code**

AB-001-011-9	Blau <i>Blue</i>	Standardobturator für Zysto-Urethroskopschäfte 9.5 Charr. <i>Standardobturator Cysto-Urethroscope sheath 9.5 Fr.</i>
AB-001-011-11	Grün <i>Green</i>	Standardobturator für Zysto-Urethroskopschäfte 11 Charr. <i>Standardobturator Cysto-Urethroscope sheath 11 Fr.</i>



Bestell-Nr.
Ordering no.

AA-005-001	Pädiatrie-Zystoskop Ø 2.7mm, Blickwinkel 0°, Arbeitslänge 187.5mm, autoklavierbar <i>Pediatric-Cystoscope Ø 2.7mm, 0° viewing angle, working length 187.5mm, autoclavable</i>
AA-005-003	Pädiatrie-Zystoskop Ø 2.7mm, Blickwinkel 30°, Arbeitslänge 187.5mm, autoklavierbar <i>Pediatric-Cystoscope Ø 2.7mm, 30° viewing angle, working length 187.5mm, autoclavable</i>
AA-005-004	Pädiatrie-Zystoskop Ø 2.7mm, Blickwinkel 70°, Arbeitslänge 187.5mm, autoklavierbar <i>Pediatric-Cystoscope Ø 2.7mm, 70° viewing angle, working length 187.5mm, autoclavable</i>



Bestell-Nr.
Ordering no.

Farbmarkierung
Colour code

AB-001-001	Rot <i>Red</i>	Zysto-Urethroskopschaft 13 Ch. mit 2 starren Hähnen, 1 x 3 Ch. Instrumentenkanal, mit Obturator <i>Cysto-Urethroscope sheath 13 Fr. with 2 fixed stopcocks, 1 x 3 Fr. instrument channel, with obturator</i>
AB-001-001-13	Rot <i>Red</i>	Zysto-Urethroskopschaft 13 Ch. mit 2 starren Hähnen, 1 x 5 Ch. oder 2 x 4 Ch. Instrumentenkanal, mit Obturator <i>Cysto-Urethroscope sheath 13 Fr. with 2 fixed stopcocks, 1 x 3 Fr. or 2 x 4 Fr. instrument channel, with obturator</i>



Bestell-Nr.
Ordering no.

Farbmarkierung
Colour code

AB-001-011	Rot <i>Red</i>	Standardobturator für Zysto-Urethroskopschäfte 13 Charr. <i>Standardobturator Cysto-Urethroscope sheath 13 Fr.</i>
-------------------	-------------------	---



Bestell-Nr.
Ordering no.

AB-003-005	Arbeitseinsatz mit Albarranhebel, 13 Charr. <i>Working element with Albaran deflector, 13 Fr.</i>
-------------------	--



Bestell-Nr.
Ordering no.



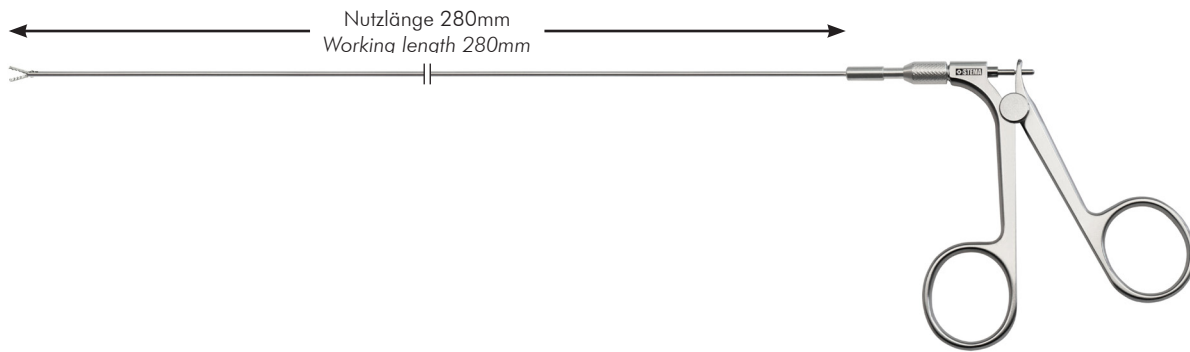









AB-003-001	Endoskopbrücke, 13 Charr. <i>Endoscope bridge, 13 Fr.</i>
-------------------	--



		Ømm	Charr. Fr.	Flexibel Flexible	Halbstarr Semi-rigid
	Probeexzisionszange oval, doppelbeweglich <i>Biopsy forceps oval, double action</i>	1.0	3	AC-001-021	AC-001-221
	Fasszange Alligatormaul, doppelbeweglich <i>Grasping forceps alligator jaw, double action</i>	1.0	3	AC-006-021	AC-006-221
	Probeexzisionszange oval, gezahnt, Zähne ineinandergreifend, doppelbeweglich <i>Biopsy forceps oval, serrated, teeth interlock, double action</i>	1.0	3	AC-015-021	AC-015-221
	Fasszange Rattenzahn, doppelbeweglich <i>Grasping forceps rat tooth, double action</i>	1.0	3	AC-019-021	AC-019-221
	Schere, einfachbeweglich <i>Scissors, single action</i>	1.0	3	AC-003-021	AC-003-221



	Bestell-Nr. Ordering no.	Charr. Fr.	
	AD-002-021	3	Nadel-Elektrode flexibel, monopolar, Länge 280mm <i>Needle electrode flexible, monopolar, length 280mm</i>
	AD-001-021	3	Knopf-Elektrode flexibel, monopolar, Länge 280mm <i>Button electrode flexible, monopolar, length 280mm</i>

Anschluss Instrumentenseite <i>Connection instrument side</i>		Anschluss Geräteseite <i>Connection unit side</i>	
 		AD-010-001 / AD-010-006 	
		AD-010-002 / AD-010-007 	
		AD-010-003 / AD-010-008 	
		AD-010-004 / AD-010-005 	
		AD-010-024 	
 	AD-010-021		
	AD-010-022		
 	AD-010-023		
<p>Alle Kabel (außer AD-010-023) passen zu den flexiblen Elektroden AD-001-021 und AD-002-021 <i>All cables (except AD-010-023) fit with the flexible electrodes AD-001-021 to AD-002-021</i></p>			

Bestell-Nr. Ordering no.	Länge Length	
AD-010-001 AD-010-006	3m 5m	Monopolares Anschlusskabel für Berchtold, Martin, Aesculap , Ø 4mm <i>Monopolar connecting cable for Berchtold, Martin, Aesculap, Ø 4mm</i>
AD-010-002 AD-010-007	3m 5m	Monopolares Anschlusskabel für Erbe, ACC/ICC, Storz , Ø 5mm <i>Monopolar connecting cable for Erbe, ACC/ICC, Storz, Ø 5mm</i>
AD-010-003 AD-010-008	3m 5m	Monopolares Anschlusskabel für Valleylab/Comned , Ø 8mm <i>Monopolar connecting cable for Valleylab/Comned, Ø 8mm</i>
AD-010-004 AD-010-005	3m 5m	Monopolares Anschlusskabel für Geräte mit 4mm Bananenstecker <i>Monopolar connecting cable for units with 4mm banana plug</i>
AD-010-024	4.5m	Monopolares Anschlusskabel für STEMA MASTER Geräte <i>Monopolar connecting cable for STEMA MASTER units</i>
AD-010-021	4.5m	Monopolares Anschlusskabel für STEMA MASTER Geräte mit SDS-Erkennung für STEMA , Ø 2mm <i>Monopolar connecting cable for STEMA MASTER units with SDS identification for STEMA, Ø 2mm</i>
AD-010-022	4.5m	Monopolares Anschlusskabel für STEMA MASTER Geräte mit SDS-Erkennung für STORZ , 90° Anschluss <i>Monopolar connecting cable for STEMA MASTER units with SDS identification for STORZ, 90° connection</i>
AD-010-023	4.5m	Monopolares Anschlusskabel für STEMA MASTER Geräte mit SDS-Erkennung für Olympus , Ø 3mm <i>Monopolar connecting cable for STEMA MASTER units with SDS identification for Olympus, Ø 3mm</i>



**Bestell-Nr.
Ordering no.**

AA-004-011	Pädiatrie-Resektoskop Ø 2.0mm, Blickwinkel 0°, Arbeitslänge 187.5mm, autoklavierbar <i>Pediatric-resectoscope Ø 2.0mm, 0° viewing angle, working length 187.5mm, autoclavable</i>
AA-005-001	Pädiatrie-Resektoskop Ø 2.7mm, Blickwinkel 0°, Arbeitslänge 187.5mm, autoklavierbar <i>Pediatric-resectoscope Ø 2.7mm, 0° viewing angle, working length 187.5mm, autoclavable</i>



**Bestell-Nr.
Ordering no.** **Farbmarkierung
Colour code**

AH-005-001	Blau <i>Blue</i>	Standard Resektoskopschaft 9 Charr. mit 1 drehbaren Hahn, ohne Obturator <i>Standard resectoscope sheath 9 Fr. with 1 rotatable stopcock, without obturator</i>
AH-004-001	Grün <i>Green</i>	Standard Resektoskopschaft 11 Charr. mit 1 drehbaren Hahn, ohne Obturator <i>Standard resectoscope sheath 11 Fr. with 1 rotatable stopcock, without obturator</i>
AH-003-001	Rot <i>Red</i>	Standard Resektoskopschaft 13 Charr. mit 1 drehbaren Hahn, ohne Obturator <i>Standard resectoscope sheath 13 Fr. with 1 rotatable stopcock, without obturator</i>



**Bestell-Nr.
Ordering no.** **Farbmarkierung
Colour code**

AH-005-011	Blau <i>Blue</i>	Standardobturator für Resektoskopschaft 9 Charr. <i>Standard obturator for Resectoscopy sheath 9 Fr.</i>
AH-004-011	Grün <i>Green</i>	Standardobturator für Resektoskopschaft 11 Charr. <i>Standard obturator for Resectoscopy sheath 11 Fr.</i>
AH-003-011	Rot <i>Red</i>	Standardobturator für Resektoskopschaft 13 Charr. <i>Standard obturator for Resectoscopy sheath 13 Fr.</i>

Für Endoskop For endoscope	Schaft Sheath	Durchmesser Diameter	Obturator Obturator
AA-004-011	AH-005-001	9 Ch./Fr.	AH-005-011
AA-004-011	AH-004-001	11 Ch. / Fr.	AH-004-011
AA-005-001	AH-003-001	13 Ch. / Fr.	AH-003-011



Bestell-Nr.
Ordering no.



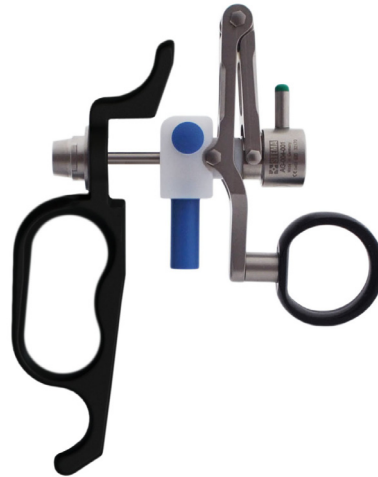

AI-003-003 Endoskopbrücke, 13 Charr.
Endoscope bridge, 13 Fr.



Bestell-Nr.
Ordering no.

- | | |
|-------------------|--|
| AG-005-001 | Arbeitsinstrument für Pädiatrie-Resektoskope, passiv schneidend, Griff offen, 9 Charr.
<i>Working element used for pediatric resectoscopes, passive cutting, handle open, 9 Fr.</i> |
| AG-004-001 | Arbeitsinstrument für Pädiatrie-Resektoskope, passiv schneidend, Griff offen, 11 Charr.
<i>Working element used for pediatric resectoscopes, passive cutting, handle open, 11 Fr.</i> |
| AG-003-001 | Arbeitsinstrument für Pädiatrie-Resektoskope, passiv schneidend, Griff offen, 13 Charr.
<i>Working element used for pediatric resectoscopes, passive cutting, handle open, 13 Fr.</i> |















	Bestell-Nr. Ordering no.	Charr. Fr.	
	AE-006-002	9 (blau) 9 (blue)	Schlingenelektrode abgewinkelt <i>Cutting loop electrode angled</i>
	AE-005-002	11 (grün) 11 (green)	Schlingenelektrode abgewinkelt <i>Cutting loop electrode angled</i>
	AE-004-002	13 (rot) 13 (red)	Schlingenelektrode abgewinkelt <i>Cutting loop electrode angled</i>
	AE-006-018	9 (blau) 9 (blue)	Schlingenelektrode klein abgewinkelt <i>Cutting loop electrode small angled</i>
	AE-005-018	11 (grün) 11 (green)	Schlingenelektrode klein abgewinkelt <i>Cutting loop electrode small angled</i>
	AE-004-018	13 (rot) 13 (red)	Schlingenelektrode klein abgewinkelt <i>Cutting loop electrode small angled</i>
	AE-006-004	9 (blau) 9 (blue)	Ballelektrode gebogen <i>Ball electrode curved</i>
	AE-005-004	11 (grün) 11 (green)	Ballelektrode gebogen <i>Ball electrode curved</i>
	AE-004-004	13 (rot) 13 (red)	Ballelektrode gebogen <i>Ball electrode curved</i>
	AE-006-016	9 (blau) 9 (blue)	Messerelektrode abgewinkelt <i>Knife electrode angled</i>
	AE-005-016	11 (grün) 11 (green)	Messerelektrode abgewinkelt <i>Knife electrode angled</i>
	AE-004-016	13 (rot) 13 (red)	Messerelektrode abgewinkelt <i>Knife electrode angled</i>
	AE-006-019	9 (blau) 9 (blue)	Hakenelektrode ohne Kugel <i>Hook electrode without ball</i>
	AE-005-019	11 (grün) 11 (green)	Hakenelektrode ohne Kugel <i>Hook electrode without ball</i>
	AE-004-019	13 (rot) 13 (red)	Hakenelektrode ohne Kugel <i>Hook electrode without ball</i>



**Bestell-Nr.
Ordering no.**

AJ-010-006

Schutzhülse aus Stahl zur Sterilisation und Aufbewahrung von Elektroden und Strikturmessern
Protection sleeve made of steel for sterilization and storage of electrodes and cold knives

Anschluss Instrumentenseite <i>Connection instrument side</i>		Anschluss Geräteseite <i>Connection unit side</i>	
 2mm 		AD-010-001 / AD-010-006 	
		AD-010-002 / AD-010-007 	
		AD-010-003 / AD-010-008 	
		AD-010-004 / AD-010-005 	
		AD-010-024 	
 2mm	 AD-010-021	AD-010-021 AD-010-022 AD-010-023 	
	 AD-010-022		
 3mm	 AD-010-023		
<p>Alle Kabel (außer AD-010-023) passen zu den Arbeitselementen AG-003-001, AG-004-001 und AG-005-001 <i>All cables (except AD-010-023) fit with the working elements AG-003-001, AG-004-001 and AG-005-001</i></p>			

Bestell-Nr. Ordering no.	Länge Length	
AD-010-001 AD-010-006	3m 5m	Monopolares Anschlusskabel für Berchtold, Martin, Aesculap , Ø 4mm <i>Monopolar connecting cable for Berchtold, Martin, Aesculap, Ø 4mm</i>
AD-010-002 AD-010-007	3m 5m	Monopolares Anschlusskabel für Erbe, ACC/ICC, Storz , Ø 5mm <i>Monopolar connecting cable for Erbe, ACC/ICC, Storz, Ø 5mm</i>
AD-010-003 AD-010-008	3m 5m	Monopolares Anschlusskabel für Valleylab/Comned , Ø 8mm <i>Monopolar connecting cable for Valleylab/Comned, Ø 8mm</i>
AD-010-004 AD-010-005	3m 5m	Monopolares Anschlusskabel für Geräte mit 4mm Bananenstecker <i>Monopolar connecting cable for units with 4mm banana plug</i>
AD-010-024	4.5m	Monopolares Anschlusskabel für STEMA MASTER Geräte <i>Monopolar connecting cable for STEMA MASTER units</i>
AD-010-021	4.5m	Monopolares Anschlusskabel für STEMA MASTER Geräte mit SDS-Erkennung für STEMA , Ø 2mm <i>Monopolar connecting cable for STEMA MASTER units with SDS identification for STEMA, Ø 2mm</i>
AD-010-022	4.5m	Monopolares Anschlusskabel für STEMA MASTER Geräte mit SDS-Erkennung für STORZ , 90° Anschluss <i>Monopolar connecting cable for STEMA MASTER units with SDS identification for STORZ, 90° connection</i>
AD-010-023	4.5m	Monopolares Anschlusskabel für STEMA MASTER Geräte mit SDS-Erkennung für Olympus , Ø 3mm <i>Monopolar connecting cable for STEMA MASTER units with SDS identification for Olympus, Ø 3mm</i>



**Bestell-Nr.
Ordering no.**

AA-004-011	Pädiatrie-Zystoskop Ø 2.0mm, Blickwinkel 0°, Arbeitslänge 187.5mm, autoklavierbar <i>Pediatric-cystoscope Ø 2.0mm, 0° viewing angle, working length 187.5mm, autoclavable</i>
AA-005-001	Pädiatrie-Zystoskop Ø 2.7mm, Blickwinkel 0°, Arbeitslänge 187.5mm, autoklavierbar <i>Pediatric-cystoscope Ø 2.7mm, 0° viewing angle, working length 187.5mm, autoclavable</i>



**Bestell-Nr.
Ordering no.** **Farbmarkierung
Colour code**

AI-004-001	Grün <i>Green</i>	Standard Urethrotomschaft 11 Charr. mit 2 starren Hähnen, mit Obturator <i>Standard urethrotome sheath 11 Fr. with 2 fixed stopcocks, with obturator</i>
AI-003-001	Rot <i>Red</i>	Standard Urethrotomschaft 13 Charr. mit 2 starren Hähnen, mit Obturator <i>Standard urethrotome sheath 13 Fr. with 2 fixed stopcocks, with obturator</i>



**Bestell-Nr.
Ordering no.** **Farbmarkierung
Colour code**

AI-004-004	Grün <i>Green</i>	Standardobturator für Urethrotomschaft 11 Charr. <i>Standard obturator for urethrotome sheath 11 Fr.</i>
AI-003-004	Rot <i>Red</i>	Standardobturator für Urethrotomschaft 13 Charr. <i>Standard obturator for urethrotome sheath 13 Fr.</i>



Bestell-Nr.
Ordering no.

AI-003-003

Endoskopbrücke mit 3 Charr. Instrumentenkanal
Endoscope bridge with 3 Fr. instrument channel

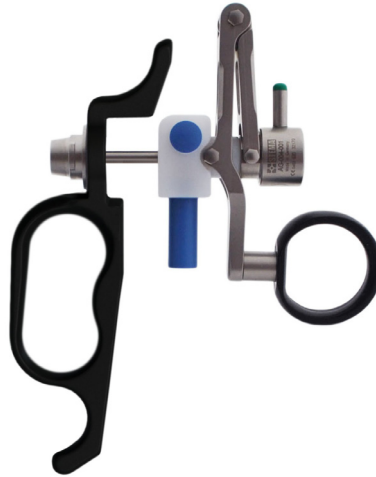

Bestell-Nr.
Ordering no.





AG-004-001

Arbeitselement für Pädiatrie-Urethroskopie, passiv schneidend, Griff geschlossen, 11 Charr.
Working element used for pediatric urethroscopy, passive cutting, handle closed, 11 Fr.

AG-003-001

Arbeitselement für Pädiatrie-Urethroskopie, passiv schneidend, Griff geschlossen, 13 Charr.
Working element used for pediatric urethroscopy, passive cutting, handle closed, 13 Fr.















	Bestell-Nr. Ordering no.	Charr. Fr.	
	AI-004-007	11 (grün) 11 (green)	Strikturmesser gerade Cold knife straight
	AI-003-007	13 (rot) 13 (red)	Strikturmesser gerade Cold knife straight
	AI-004-009	11 (grün) 11 (green)	Strikturmesser rund Cold knife round
	AI-003-009	13 (rot) 13 (red)	Strikturmesser rund Cold knife round
	AI-004-010	11 (grün) 11 (green)	Strikturmesser ringförmig Cold knife ring shaped
	AI-003-010	13 (rot) 13 (red)	Strikturmesser ringförmig Cold knife ring shaped
	AI-004-011	11 (grün) 11 (green)	Strikturmesser hakenförmig Cold knife hook shaped
	AI-003-011	13 (rot) 13 (red)	Strikturmesser hakenförmig Cold knife hook shaped



**Bestell-Nr.
Ordering no.**

AJ-010-006

Schutzhülse aus Stahl zur Sterilisation und Aufbewahrung von Elektroden und Strikturmessern
Protection sleeve made of steel for sterilization and storage of electrodes and cold knives

Anschluss Instrumentenseite <i>Connection instrument side</i>		Anschluss Geräteseite <i>Connection unit side</i>	
 2mm 		AD-010-001 / AD-010-006 	
		AD-010-002 / AD-010-007 	
		AD-010-003 / AD-010-008 	
		AD-010-004 / AD-010-005 	
		AD-010-024 	
 2mm	 AD-010-021	AD-010-021 AD-010-022 AD-010-023 	
	 AD-010-022		
 3mm	 AD-010-023		
Alle Kabel (außer AD-010-023) passen zu den Arbeitselementen AG-003-001 und AG-004-001 <i>All cables (except AD-010-023) fit with the working elements AG-003-001 and AG-004-001</i>			

Bestell-Nr. Ordering no.	Länge Length	
AD-010-001 AD-010-006	3m 5m	Monopolares Anschlusskabel für Berchtold, Martin, Aesculap , Ø 4mm <i>Monopolar connecting cable for Berchtold, Martin, Aesculap, Ø 4mm</i>
AD-010-002 AD-010-007	3m 5m	Monopolares Anschlusskabel für Erbe, ACC/ICC, Storz , Ø 5mm <i>Monopolar connecting cable for Erbe, ACC/ICC, Storz, Ø 5mm</i>
AD-010-003 AD-010-008	3m 5m	Monopolares Anschlusskabel für Valleylab/Comned , Ø 8mm <i>Monopolar connecting cable for Valleylab/Comned, Ø 8mm</i>
AD-010-004 AD-010-005	3m 5m	Monopolares Anschlusskabel für Geräte mit 4mm Bananenstecker <i>Monopolar connecting cable for units with 4mm banana plug</i>
AD-010-024	4.5m	Monopolares Anschlusskabel für STEMA MASTER Geräte <i>Monopolar connecting cable for STEMA MASTER units</i>
AD-010-021	4.5m	Monopolares Anschlusskabel für STEMA MASTER Geräte mit SDS-Erkennung für STEMA , Ø 2mm <i>Monopolar connecting cable for STEMA MASTER units with SDS identification for STEMA, Ø 2mm</i>
AD-010-022	4.5m	Monopolares Anschlusskabel für STEMA MASTER Geräte mit SDS-Erkennung für STORZ , 90° Anschluss <i>Monopolar connecting cable for STEMA MASTER units with SDS identification for STORZ, 90° connection</i>
AD-010-023	4.5m	Monopolares Anschlusskabel für STEMA MASTER Geräte mit SDS-Erkennung für Olympus , Ø 3mm <i>Monopolar connecting cable for STEMA MASTER units with SDS identification for Olympus, Ø 3mm</i>

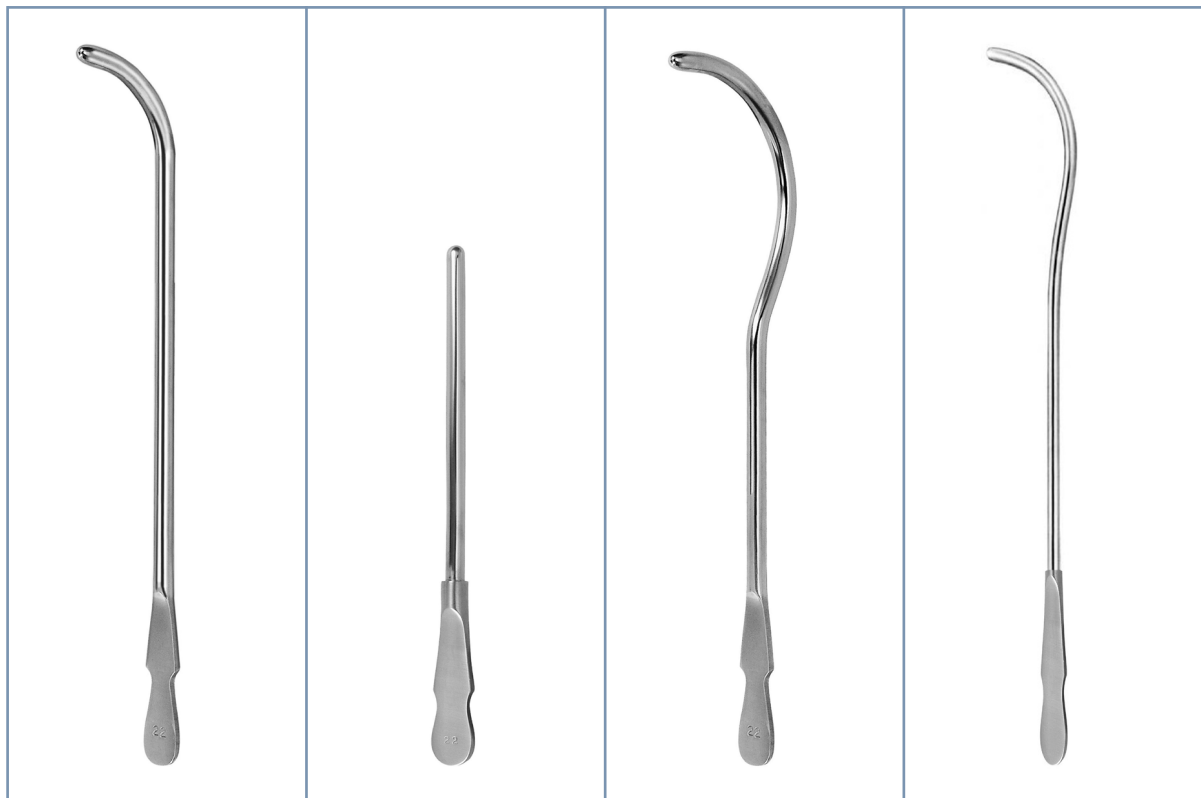

Van Buren
Van Buren

Dittel, gerade
Dittel, straight

Dittel, gebogen
Dittel, curved

Guyon
Guyon

Charr. Fr.	Bestell-Nr. Ordering no.	Bestell-Nr. Ordering no.	Bestell-Nr. Ordering no.	Bestell-Nr. Ordering no.
8	AJ-003-001	AJ-003-021	AJ-003-050	AJ-003-170
9		AJ-003-022	AJ-003-051	AJ-003-171
10	AJ-003-002	AJ-003-023	AJ-003-052	AJ-003-172
11		AJ-003-024	AJ-003-053	AJ-003-173
12	AJ-003-003	AJ-003-025	AJ-003-054	AJ-003-174
13		AJ-003-026	AJ-003-055	AJ-003-175
14	AJ-003-004	AJ-003-027	AJ-003-056	AJ-003-176
15		AJ-003-028	AJ-003-057	AJ-003-177
16	AJ-003-005	AJ-003-029	AJ-003-058	AJ-003-178
17		AJ-003-030	AJ-003-059	AJ-003-179
18	AJ-003-006	AJ-003-031	AJ-003-060	AJ-003-180
19		AJ-003-032	AJ-003-061	AJ-003-181
20	AJ-003-007	AJ-003-033	AJ-003-062	AJ-003-182
21		AJ-003-034	AJ-003-063	AJ-003-183
22	AJ-003-008	AJ-003-035	AJ-003-064	AJ-003-184
23		AJ-003-036	AJ-003-065	AJ-003-185
24	AJ-003-009	AJ-003-037	AJ-003-066	AJ-003-186
25		AJ-003-038	AJ-003-067	AJ-003-187
26	AJ-003-010	AJ-003-039	AJ-003-068	AJ-003-188
27		AJ-003-040	AJ-003-069	AJ-003-189
28	AJ-003-011	AJ-003-041	AJ-003-070	AJ-003-190
29		AJ-003-042	AJ-003-071	AJ-003-191
30	AJ-003-012	AJ-003-043	AJ-003-072	AJ-003-192
31				AJ-003-193
32	AJ-003-013	AJ-003-044	AJ-003-074	AJ-003-194
33				AJ-003-195
34	AJ-003-014	AJ-003-045		AJ-003-196
35				AJ-003-197
36	AJ-003-015	AJ-003-046		AJ-003-198
37				AJ-003-199
38	AJ-003-016			AJ-003-200

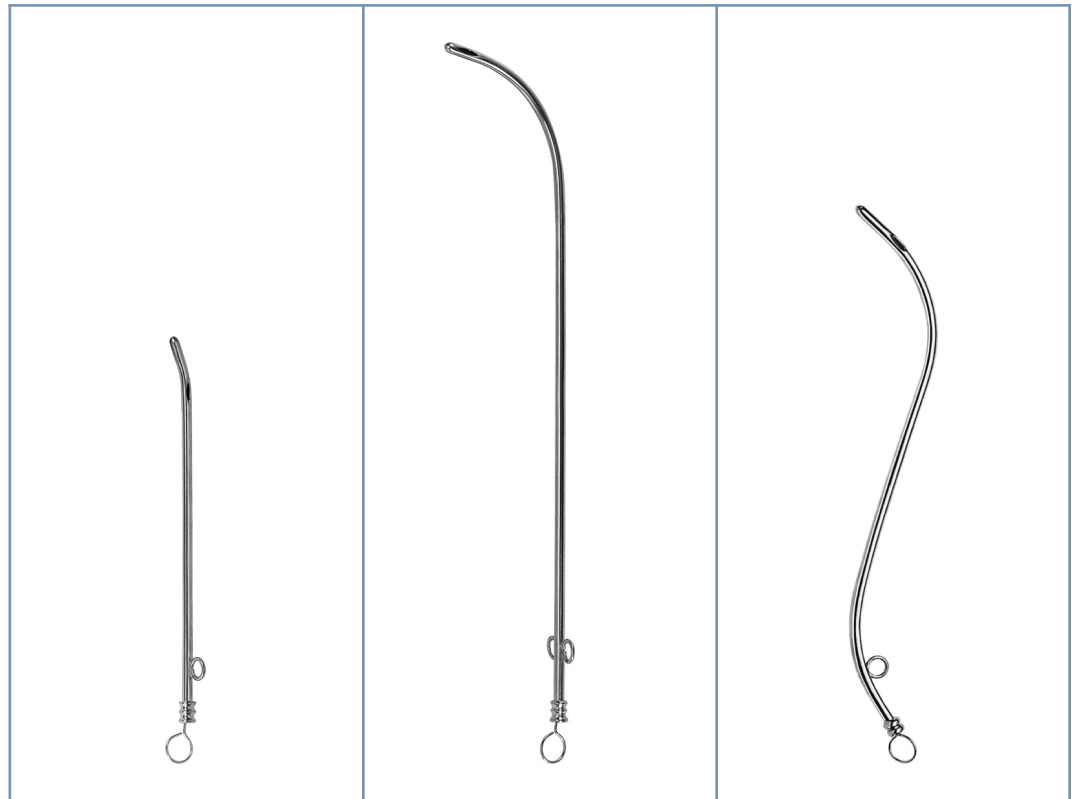

Für Männer <i>For men</i>	Für Frauen <i>For women</i>	Coxeter Prostata <i>Coxeter prostata</i>
------------------------------	--------------------------------	---

Charr. Fr.	Bestell-Nr. Ordering no.	Bestell-Nr. Ordering no.	Bestell-Nr. Ordering no.
6	AJ-003-080	AJ-003-100	
7	AJ-003-081	AJ-003-101	
8	AJ-003-082	AJ-003-102	AJ-003-120
9	AJ-003-083	AJ-003-103	
10	AJ-003-084	AJ-003-104	AJ-003-121
11	AJ-003-085	AJ-003-105	
12	AJ-003-086	AJ-003-106	AJ-003-122
13	AJ-003-087	AJ-003-107	
14	AJ-003-088	AJ-003-108	AJ-003-123
15	AJ-003-089	AJ-003-109	
16	AJ-003-090	AJ-003-110	AJ-003-124
17	AJ-003-091	AJ-003-111	
18	AJ-003-092	AJ-003-112	AJ-003-125
19	AJ-003-093	AJ-003-113	
20	AJ-003-094	AJ-003-114	AJ-003-126
21	AJ-003-095	AJ-003-115	
22	AJ-003-096	AJ-003-116	AJ-003-127
23	AJ-003-097	AJ-003-117	
24	AJ-003-098	AJ-003-118	AJ-003-128



**Bestell-Nr.
 Ordering no.**



AJ-003-142 Katheterspanner Guyon gerade, 39cm
 Catheter introducer Guyon straight, 39cm



AJ-003-143 Katheterspanner Guyon gebogen, 39cm
 Catheter introducer Guyon curved, 39cm

**Bestell-Nr.
 Ordering no.**

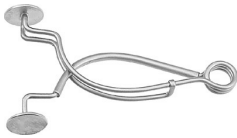

AJ-003-140 Penisklemme Stockmann, 8cm
 Meatus clamp Stockmann, 8cm



AJ-003-141 Penisklemme Strauss 11cm
 Meatus clamp Strauss, 11cm



**Bestell-Nr.
 Ordering no.**



AJ-006-012 Sekretlöffel Guttman, 26.5cm
 Secretion spoon Guttman, 26.5cm

**Bestell-Nr.
 Ordering no.**



AJ-010-011 Luer-Lock Schlauchverbinder, männlicher Luer-Lock innen Ø 3.0mm,
 Schlauchverbinder Ø 6.0mm
 Luer-Lock tubing connector, male Luer-Lock inside Ø 3.0mm,
 tubing connector Ø 6.0mm



AJ-010-012 Luer-Lock Schlauchverbinder mit Absperrhahn
 Luer-Lock tubing connector with stopcock



AJ-010-013 Luer-Lock Schlauchverbinder, männlicher Luer-Lock innen,
 Schlauchverbinder Ø 9mm
 Luer-Lock tubing connector, male Luer-Lock inside,
 tubing connector Ø 9.0mm



AJ-010-018 Hahn links mit Luer-Lock, männlich, Schlauchverbinder 9mm
 Stopcock left with Luer-Lock, male, tubing connector 9mm

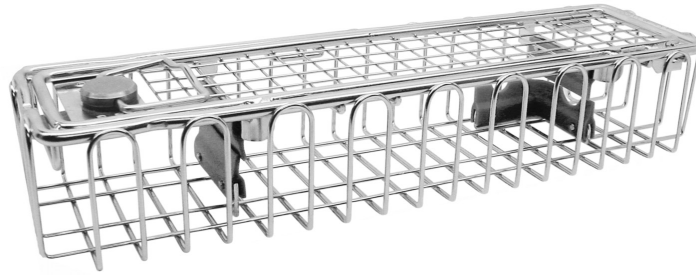

Bestell-Nr.
Ordering no.

FA-010-001 Siebkorb für 1 Endoskop mit Deckel, Abmessungen **290** x 80 x 52mm (L x B x H)
*Wire basket for 1 endoscope with lid, dimensions **290** x 80 x 52mm (l x w x h)*

FA-010-002 Siebkorb für 1 Endoskop mit Deckel, Abmessungen **460** x 80 x 52mm (L x B x H)
*Wire basket for 1 endoscope with lid, dimensions **460** x 80 x 52mm (l x w x h)*

FA-010-003 Siebkorb für 1 Endoskop, Abmessungen **670** x 80 x 52mm (L x B x H)
*Wire basket for 1 endoscope with lid, dimensions **670** x 80 x 52mm (l x w x h)*

FA-010-004 Siebkorb für 2 Endoskope mit Deckel, Abmessungen **290** x 80 x 52mm (L x B x H)
*Wire basket for 2 endoscopes with lid, dimensions **290** x 80 x 52mm (l x w x h)*

FA-010-005 Siebkorb für 2 Endoskope mit Deckel, Abmessungen **460** x 80 x 52mm (L x B x H)
*Wire basket for 2 endoscopes with lid, dimensions **460** x 80 x 52mm (l x w x h)*

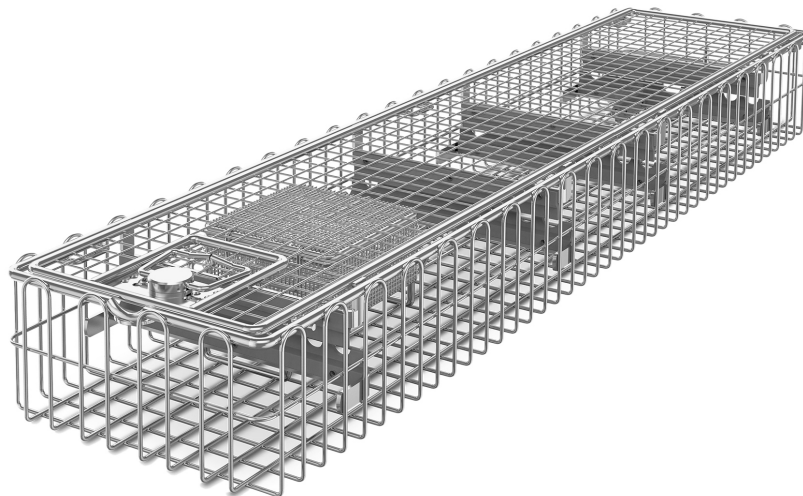

Bestell-Nr.
Ordering no.

FA-010-006 Siebkorb für 1 Endoskop und 1 Kaltlichtkabel mit Deckel, Abmessungen **670** x 80 x 52mm (L x B x H)
*Wire basket for 1 endoscope and 1 cold light cable with lid, dimensions **670** x 80 x 52mm (l x w x h)*

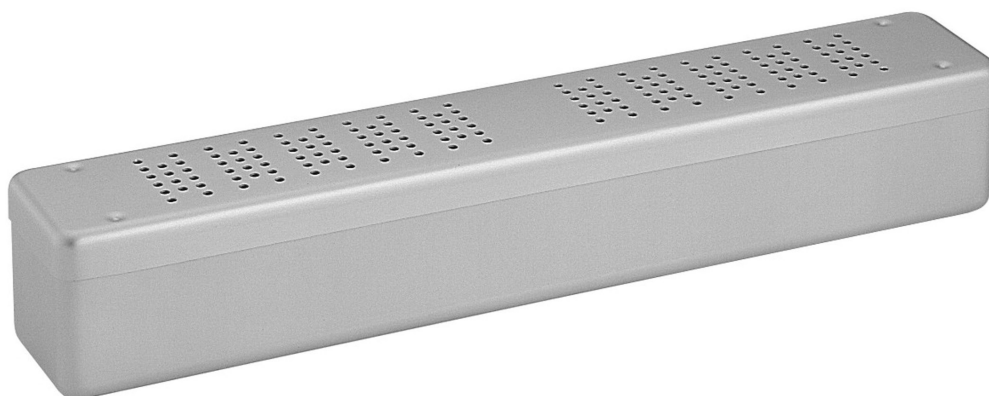

Bestell-Nr.
Ordering no.

FA-001-001	Endoskop-Container, Deckel und Boden gelocht (ohne Filter), 450 x 70 x 70mm (L x B x H), silber <i>Endoscope container, lid and bottom perforated (without filter), 450 x 70 x 70mm (l x w x h), silver</i>
FA-001-001-R	Endoskop-Container, Deckel und Boden gelocht (ohne Filter), 450 x 70 x 70mm (L x B x H), rot <i>Endoscope container, lid and bottom perforated (without filter), 450 x 70 x 70mm (l x w x h), red</i>
FA-001-001-G	Endoskop-Container, Deckel und Boden gelocht (ohne Filter), 450 x 70 x 70mm (L x B x H), grün <i>Endoscope container, lid and bottom perforated (without filter), 450 x 70 x 70mm (l x w x h), green</i>
FA-002-001	Endoskop-Container, Deckel und Boden gelocht (ohne Filter), 250 x 60 x 50mm (L x B x H), silber <i>Endoscope container, lid and bottom perforated (without filter), 250 x 60 x 50mm (l x w x h), silver</i>
FA-002-001-R	Endoskop-Container, Deckel und Boden gelocht (ohne Filter), 250 x 60 x 50mm (L x B x H), rot <i>Endoscope container, lid and bottom perforated (without filter), 250 x 60 x 50mm (l x w x h), red</i>
FA-002-001-G	Endoskop-Container, Deckel und Boden gelocht (ohne Filter), 250 x 60 x 50mm (L x B x H), grün <i>Endoscope container, lid and bottom perforated (without filter), 250 x 60 x 50mm (l x w x h), green</i>

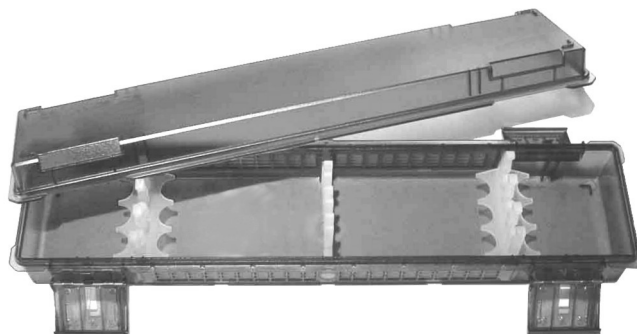

Bestell-Nr.
Ordering no.

FA-020-001	Endoskop-Container, Spezialkunststoff, Innenabmessungen 420 x 85 x 60mm (L x B x H) <i>Endoscope container, special plastic material, inner dimension 420 x 85 x 60mm (l x w x h)</i>
FA-020-010	Silikoneinsatz für Endoskop-Container FA-020-001 (ohne Abbildung) <i>Silicone insert for endoscope container FA-020-001 (without illustration)</i>
FA-020-011	Langzeitfilter für FA-020-001, 2 Stück (ohne Abbildung) <i>Long term filter for FA-020-001, 2 pieces (without illustration)</i>



Info: Für weitere Modelle fordern Sie bitte unseren Katalog für [Container-Systeme](#) an.
Info: For further models please kindly request our catalogue for [Container-Systems](#).

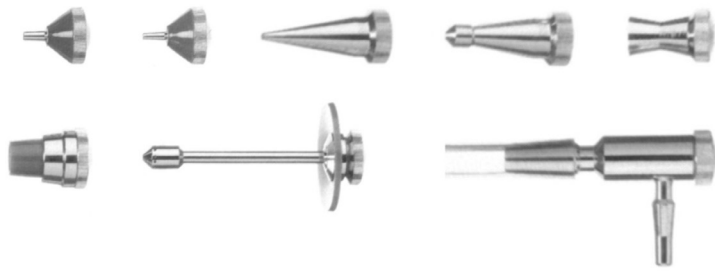

Bestell-Nr.
Ordering no.

EJ-030-010 Reinigungspistole komplett inklusive 9 verschiedenen Aufsätzen
Cleaning pistol complete inclusive 9 different tips



Bestell-Nr.
Ordering no.

EJ-030-001 Ø 3mm Reinigungsbürste, Länge 420mm, Packung mit 10 Stück
Ø 3mm cleaning brush, length 420mm, package of 10 pieces

EJ-030-002 Ø 5mm Reinigungsbürste, Länge 420mm, Packung mit 10 Stück
Ø 5mm cleaning brush, length 420mm, package of 10 pieces

EJ-030-003 Ø 10mm Reinigungsbürste, Länge 420mm, Packung mit 10 Stück
Ø 10mm cleaning brush, length 420mm, package of 10 pieces



Bestell-Nr.
Ordering no.

EJ-030-031 Spezialfett für Hähne, Ventile und Instrumente, Tube mit 8 Gramm
Special grease for stopcocks, valves and instruments, tube with 8 grams



Bestell-Nr.
Ordering no.

EJ-030-032 Polierpaste für Optiken, Tube mit 3 Gramm, 50 Stück / Pack
Polishing paste for scopes, tube with 3 grams, 50 pieces / pack

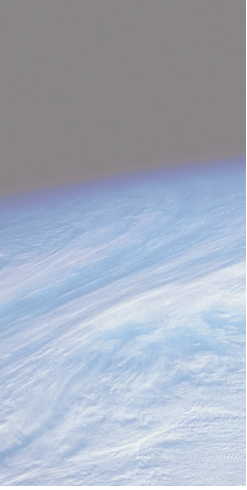

HYSTEROSKOPIE

HYSTEROSCOPY



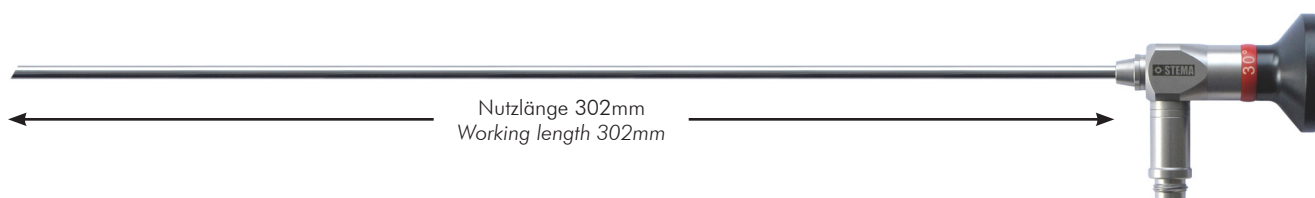

Bestell-Nr. Ordering no.	Durchmesser Diameter	Blickrichtung Direction of view	Farbmarkierung Colour code
AA-001-001	2.7mm	0°	Grün Green
AA-001-002	2.7mm	12°	Weiß White
AA-001-003	2.7mm	30°	Rot Red
AA-001-004	2.7mm	70°	Gelb Yellow
AA-003-001	2.9mm	0°	Grün Green
AA-003-004	2.9mm	12°	Weiß White
AA-003-002	2.9mm	30°	Rot Red
AA-003-002-W	2.9mm	30° - Weitwinkel 30° - Wide angle	Rot Red
AA-003-003	2.9mm	70°	Gelb Yellow
AA-002-001	4.0mm	0°	Grün Green
AA-002-001-W	4.0mm	0° - Weitwinkel 0° - Wide angle	Grün Green
AA-002-002	4.0mm	12°	Weiß White
AA-002-003	4.0mm	30°	Rot Red
AA-002-003-W	4.0mm	30° - Weitwinkel 30° - Wide angle	Rot Red
AA-002-004	4.0mm	70°	Gelb Yellow
AA-002-004-W	4.0mm	70° - Weitwinkel 70° - Wide angle	Gelb Yellow

STEMA **High Definition**

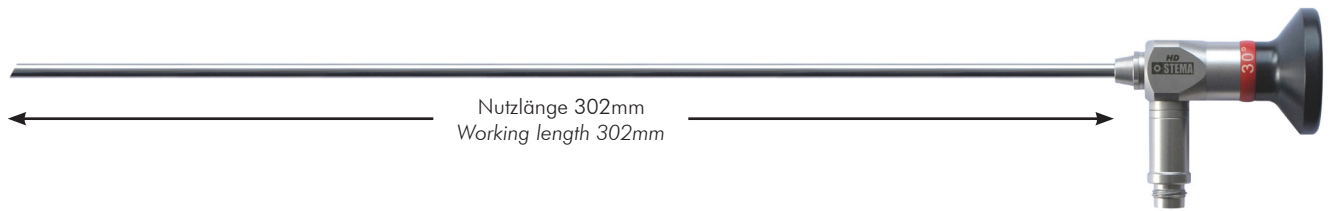

Bestell-Nr. Ordering no.	Durchmesser Diameter	Blickrichtung Direction of view	Farbmarkierung Colour code
AA-001-011	2.7mm	0°	Grün Green
AA-001-012	2.7mm	12°	Weiß White
AA-001-013	2.7mm	30°	Rot Red
AA-001-014	2.7mm	70°	Gelb Yellow
AA-003-011	2.9mm	0°	Grün Green
AA-003-014	2.9mm	12°	Weiß White
AA-003-012	2.9mm	30°	Rot Red
AA-003-012-W	2.9mm	30° - Weitwinkel 30° - Wide angle	Rot Red
AA-002-011	4.0mm	0°	Grün Green
AA-002-011-W	4.0mm	0° - Weitwinkel 0° - Wide angle	Grün Green
AA-002-012	4.0mm	12°	Weiß White
AA-002-013	4.0mm	30°	Rot Red
AA-002-013-W	4.0mm	30° - Weitwinkel 30° - Wide angle	Rot Red
AA-002-014	4.0mm	70°	Gelb Yellow

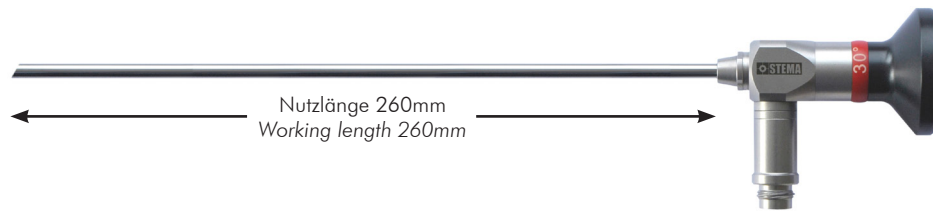

Bestell-Nr. Ordering no.	Durchmesser Diameter	Blickrichtung Direction of view	Farbmarkierung Colour code
AA-004-001	2.0mm	0°	Grün Green
AA-004-002	2.0mm	30°	Rot Red

Unsere Schäfte sind mit allen HD Optiken kompatibel
Our sheaths are compatible with all HD scopes



Bestell-Nr. Ordering no.	
AA-004-001	Hysteroskop Ø 2.0mm, Blickwinkel 0°, autoklavierbar, 260mm Hysteroscope Ø 2.0mm, 0° viewing angle, autoclavable, 260mm
AA-004-002	Hysteroskop Ø 2.0mm, Blickwinkel 30°, autoklavierbar, 260mm Hysteroscope Ø 2.0mm, 30° viewing angle, autoclavable, 260mm
AA-001-001	Hysteroskop Ø 2.7mm, Blickwinkel 0°, autoklavierbar, 302mm Hysteroscope Ø 2.7mm, 0° viewing angle, autoclavable, 302mm
AA-001-003	Hysteroskop Ø 2.7mm, Blickwinkel 30°, autoklavierbar, 302mm Hysteroscope Ø 2.7mm, 30° viewing angle, autoclavable, 302mm
AA-003-001	Hysteroskop Ø 2.9mm, Blickwinkel 0°, autoklavierbar, 302mm Hysteroscope Ø 2.9mm, 0° viewing angle, autoclavable, 302mm
AA-003-002	Hysteroskop Ø 2.9mm, Blickwinkel 30°, autoklavierbar, 302mm Hysteroscope Ø 2.9mm, 30° viewing angle, autoclavable, 302mm
AA-002-001	Hysteroskop Ø 4.0mm, Blickwinkel 0°, autoklavierbar, 302mm Hysteroscope Ø 4.0mm, 0° viewing angle, autoclavable, 302mm
AA-002-002	Hysteroskop Ø 4.0mm, Blickwinkel 12°, autoklavierbar, 302mm Hysteroscope Ø 4.0mm, 12° viewing angle, autoclavable, 302mm
AA-002-003	Hysteroskop Ø 4.0mm, Blickwinkel 30°, autoklavierbar, 302mm Hysteroscope Ø 4.0mm, 30° viewing angle, autoclavable, 302mm

**Schaffform /
Shape of sheath**



Schaft / Sheath



Obturator / Obturator



Für Endoskop For endoscope	Schaft Sheath	Durchmesser Diameter	Nutzlänge Working length	Obturator Obturator
AA-002-001 AA-002-002	AN-003-001	5.1mm	277mm	AN-003-003
AA-002-002 AA-002-003	AN-003-002	5.1mm	277mm	AN-003-003
AA-001-001 AA-003-001	AN-002-001	4.0mm	277mm	AN-002-003
AA-001-003 AA-003-002	AN-002-002	4.0mm	277mm	AN-002-003

Unsere Schäfte sind mit allen HD Optiken kompatibel
Our sheaths are compatible with all HD scopes



**Bestell-Nr.
Ordering no.**

AA-004-001	Hysteroskop Ø 2.0mm, Blickwinkel 0°, autoklavierbar, 260mm Hysteroscope Ø 2.0mm, 0° viewing angle, autoclavable, 260mm
AA-004-002	Hysteroskop Ø 2.0mm, Blickwinkel 30°, autoklavierbar, 260mm Hysteroscope Ø 2.0mm, 30° viewing angle, autoclavable, 260mm
AA-001-001	Hysteroskop Ø 2.7mm, Blickwinkel 0°, autoklavierbar, 302mm Hysteroscope Ø 2.7mm, 0° viewing angle, autoclavable, 302mm
AA-001-003	Hysteroskop Ø 2.7mm, Blickwinkel 30°, autoklavierbar, 302mm Hysteroscope Ø 2.7mm, 30° viewing angle, autoclavable, 302mm
AA-003-001	Hysteroskop Ø 2.9mm, Blickwinkel 0°, autoklavierbar, 302mm Hysteroscope Ø 2.9mm, 0° viewing angle, autoclavable, 302mm
AA-003-002	Hysteroskop Ø 2.9mm, Blickwinkel 30°, autoklavierbar, 302mm Hysteroscope Ø 2.9mm, 30° viewing angle, autoclavable, 302mm
AA-002-001	Hysteroskop Ø 4.0mm, Blickwinkel 0°, autoklavierbar, 302mm Hysteroscope Ø 4.0mm, 0° viewing angle, autoclavable, 302mm
AA-002-002	Hysteroskop Ø 4.0mm, Blickwinkel 12°, autoklavierbar, 302mm Hysteroscope Ø 4.0mm, 12° viewing angle, autoclavable, 302mm
AA-002-003	Hysteroskop Ø 4.0mm, Blickwinkel 30°, autoklavierbar, 302mm Hysteroscope Ø 4.0mm, 30° viewing angle, autoclavable, 302mm

**Schaftform /
Shape of sheath**



Innenschaft / Inner sheath

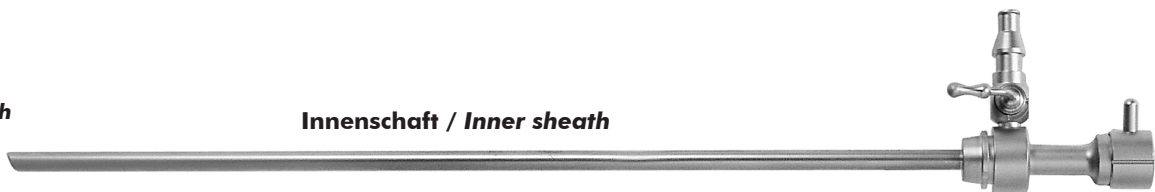

Aussenschaft / Outer sheath

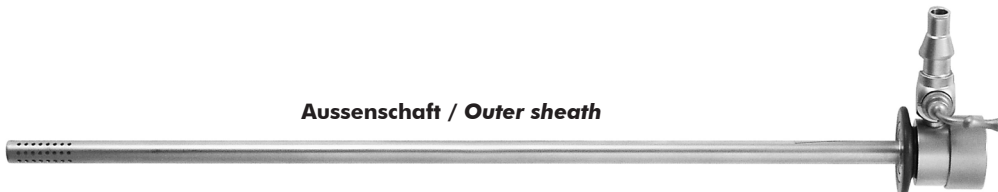

Obturator / Obturator



Für Endoskop For endoscope	Aussenschaft Ø / Nutzlänge Outer sheath Ø / Working length	Innenschaft Ø / Nutzlänge Inner sheath Ø / Working length	Obturator Obturator	Farbe Colour
AA-002-001 AA-002-002	AN-003-103 6.5mm / 246mm	AN-003-101 5.4mm / 261mm	AN-003-104	Blau Blue
AA-002-002 AA-002-003	AN-003-103 6.5mm / 246mm	AN-003-102 5.4mm / 261mm	AN-003-104	Blau Blue
AA-001-001 AA-003-001	AN-002-103 5.0mm / 246mm	AN-002-101 3.7mm / 261mm	AN-002-104	Weiß White
AA-001-003 AA-003-002	AN-002-103 5.0mm / 246mm	AN-002-102 3.7mm / 261mm	AN-002-104	Weiß White
AA-004-001	AN-001-103 3.4mm / 204mm	AN-001-101 2.6mm / 219mm	AN-001-104	Rot Red
AA-004-002	AN-001-103 3.4mm / 204mm	AN-001-102 2.6mm / 219mm	AN-001-104	Rot Red

Unsere Schäfte sind mit allen HD Optiken kompatibel
Our sheaths are compatible with all HD scopes



Bestell-Nr. Ordering no.	
AA-001-001	Hysteroskop Ø 2.7mm, Blickwinkel 0°, autoklavierbar, 302mm Hysteroscope Ø 2.7mm, 0° viewing angle, autoclavable, 302mm
AA-001-003	Hysteroskop Ø 2.7mm, Blickwinkel 30°, autoklavierbar, 302mm Hysteroscope Ø 2.7mm, 30° viewing angle, autoclavable, 302mm
AA-003-001	Hysteroskop Ø 2.9mm, Blickwinkel 0°, autoklavierbar, 302mm Hysteroscope Ø 2.9mm, 0° viewing angle, autoclavable, 302mm
AA-003-002	Hysteroskop Ø 2.9mm, Blickwinkel 30°, autoklavierbar, 302mm Hysteroscope Ø 2.9mm, 30° viewing angle, autoclavable, 302mm
AA-002-001	Hysteroskop Ø 4.0mm, Blickwinkel 0°, autoklavierbar, 302mm Hysteroscope Ø 4.0mm, 0° viewing angle, autoclavable, 302mm
AA-002-002	Hysteroskop Ø 4.0mm, Blickwinkel 12°, autoklavierbar, 302mm Hysteroscope Ø 4.0mm, 12° viewing angle, autoclavable, 302mm
AA-002-003	Hysteroskop Ø 4.0mm, Blickwinkel 30°, autoklavierbar, 302mm Hysteroscope Ø 4.0mm, 30° viewing angle, autoclavable, 302mm

**Schaftform /
Shape of sheath**

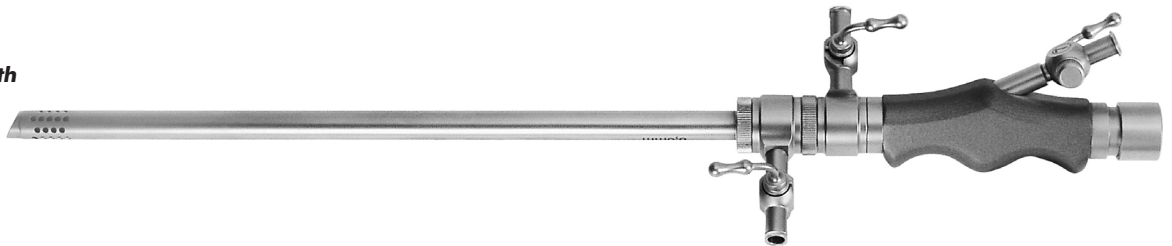

Für Endoskop For endoscope	Bestell-Nr. Ordering no.	Durchmesser Diameter	Durchlass Instrumentenkanal Capacity instrument channel	Nutzlänge Working length
AA-001-001 AA-003-001	AN-002-201	6.0mm	5 Charr. 5 Fr.	193mm
AA-001-003 AA-003-002	AN-002-202	6.0mm	5 Charr. 5 Fr.	193mm
AA-002-002 AA-002-001	AN-003-201	8.0mm	7 Charr. 7 Fr.	193mm
AA-002-002 AA-002-003	AN-003-202	8.0mm	7 Charr. 7 Fr.	193mm

Unsere Schäfte sind mit allen HD Optiken kompatibel
Our sheaths are compatible with all HD scopes



Bestell-Nr.
Ordering no.

AA-002-003	Hysteroskop Ø 4.0mm, Blickwinkel 30°, autoklavierbar, 302mm Hysteroscope Ø 4.0mm, 30° viewing angle, autoclavable, 302mm
AA-002-013	HD Hysteroskop Ø 4.0mm, Blickwinkel 30°, autoklavierbar, 302mm HD Hysteroscope Ø 4.0mm, 30° viewing angle, autoclavable, 302mm
AA-002-023	Ultra HD Hysteroskop Ø 4.0mm, Blickwinkel 30°, autoklavierbar, 302mm Ultra HD Hysteroscope Ø 4.0mm, 30° viewing angle, autoclavable, 302mm

Schaftform /
Shape of sheath



Arbeitseinsatz /
Working element



Außenschaft / Outer sheath

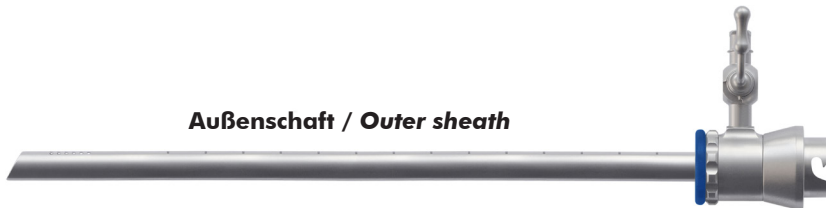

Obturator / Obturator



Für Endoskop For endoscope	Schaft Sheath	Durchmesser Diameter	Nutzlänge Working length	Arbeitseinsatz Working element	Obturator Obturator	Farbe Colour
AA-002-003	AN-003-302	8.0mm	180mm	AN-003-301	AN-003-303	Blau Blue

Unsere Schäfte sind mit allen HD Optiken kompatibel
Our sheaths are compatible with all HD scopes



Bestell-Nr.
Ordering no.

AA-004-002	Hysteroskop Ø 2.0mm, Blickwinkel 30°, autoklavierbar, 260mm Hysteroscope Ø 2.0mm, 30° viewing angle, autoclavable, 260mm
AA-003-002	Hysteroskop Ø 2.9mm, Blickwinkel 30°, autoklavierbar, 302mm Hysteroscope Ø 2.9mm, 30° viewing angle, autoclavable, 302mm
AA-003-012	HD Hysteroskop Ø 2.9mm, Blickwinkel 30°, autoklavierbar, 302mm HD Hysteroscope Ø 2.9mm, 30° viewing angle, autoclavable, 302mm
AA-002-003	Hysteroskop Ø 4.0mm, Blickwinkel 30°, autoklavierbar, 302mm Hysteroscope Ø 4.0mm, 30° viewing angle, autoclavable, 302mm
AA-002-013	HD Hysteroskop Ø 4.0mm, Blickwinkel 30°, autoklavierbar, 302mm HD Hysteroscope Ø 4.0mm, 30° viewing angle, autoclavable, 302mm

Schaftform /
Shape of sheath



Innenschaft / Inner sheath

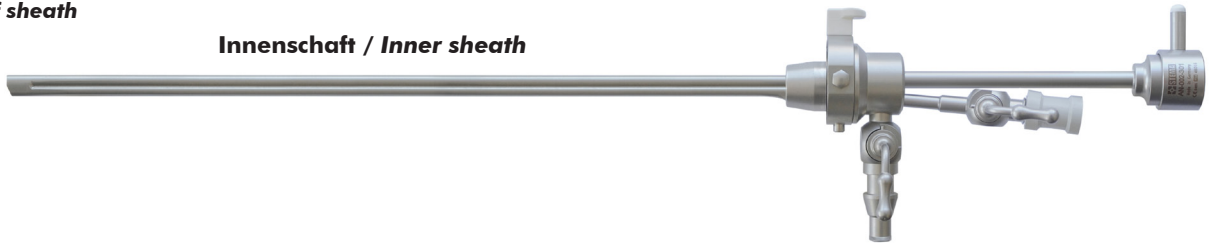

Aussenschaft / Outer sheath

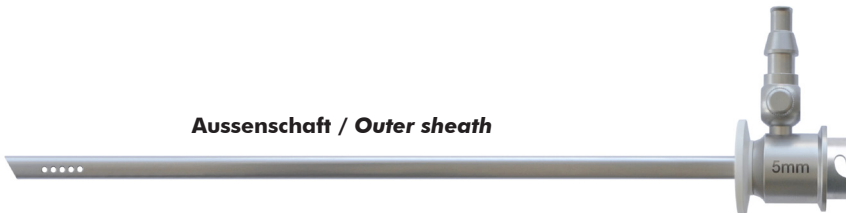

Für Endoskop For endoscope	Aussenschaft Outer sheath	Innenschaft Inner sheath	Ø Schaft Ø sheath	Arbeitskanal Working channel	Nutzlänge Working length	Farbe Colour
AA-004-002	AN-001-302	AN-001-301	4.3mm	5 Charr. 5 Fr.	181mm	Rot Red
AA-003-002 AA-003-012	AN-002-302	AN-002-301	5.0mm	5 Charr. 5 Fr.	192mm	Weiß White
AA-003-002 AA-003-012	AN-002-308	AN-002-307	6.3mm	9 Charr. 9 Fr.	192mm	Gelb Yellow
AA-002-003 AA-002-013	AN-005-304	AN-005-303	7.0mm	7 Charr. 7 Fr.	192mm	Grün Green
AA-002-003 AA-002-013	AN-005-302	AN-005-301	6.5mm	5 Charr. 5 Fr.	192mm	Blau Blue

Unsere Schäfte sind mit allen HD Optiken kompatibel
Our sheaths are compatible with all HD scopes



Bestell-Nr.
Ordering no.

AA-002-001	Hysteroskop Ø 4.0mm, Blickwinkel 0°, autoklavierbar, 302mm Hysteroscope Ø 4.0mm, 0° viewing angle, autoclavable, 302mm
AA-002-002	Hysteroskop Ø 4.0mm, Blickwinkel 12°, autoklavierbar, 302mm Hysteroscope Ø 4.0mm, 12° viewing angle, autoclavable, 302mm
AA-002-003	Hysteroskop Ø 4.0mm, Blickwinkel 30°, autoklavierbar, 302mm Hysteroscope Ø 4.0mm, 30° viewing angle, autoclavable, 302mm
AA-002-004	Hysteroskop Ø 4.0mm, Blickwinkel 70°, autoklavierbar, 302mm Hysteroscope Ø 4.0mm, 70° viewing angle, autoclavable, 302mm

Schaffform /
Shape of sheath

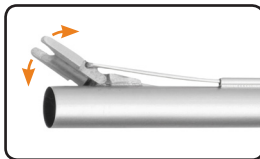

Arbeitseinsatz /
Working element

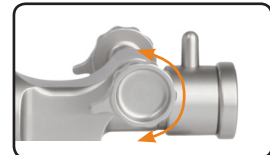
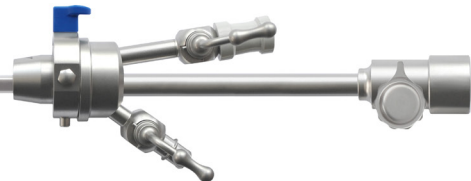

Aussenschaft /
Outer sheath

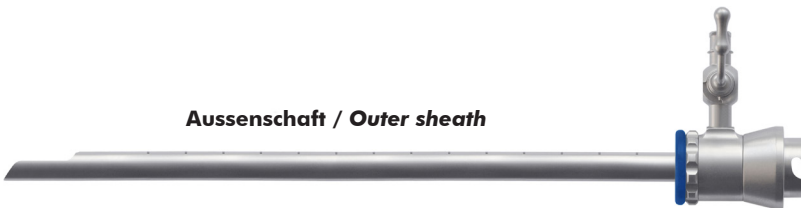

Obturator /
Obturator



Für Endoskop For endoscope	Schaft Sheath	Durchmesser Diameter	Nutzlänge Working length	Arbeitseinsatz Working element	Obturator Obturator	Farbe Colour
AA-002-001 AA-002-002 AA-002-003 AA-002-004	AN-004-401	8.0mm	180mm	AN-004-402	AN-004-403	Blau Blue

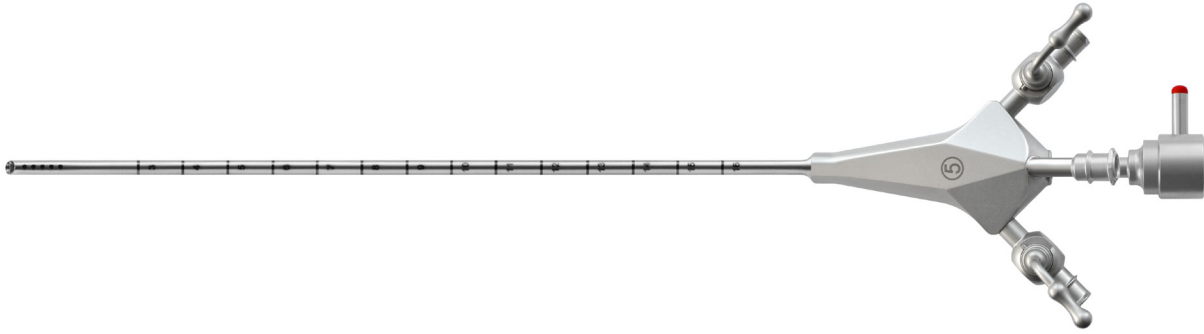

Bestell-Nr. Ordering no.	Farbmarkierung Colour code	
AN-001-310	Rot Red	HIGH-FLOW OP-Dauerspül-Hysteroskopschaft Ø 4.3mm , für 5 Ch. flexible und halbstarre Instrumente zur Verwendung mit 2.0mm Optiken (12° und 30°), Einschafsystem <i>HIGH-FLOW OP-Continuous-flow-hysteroscope sheath Ø 4.3mm, for 5 Fr. flexible and semirigid instruments for use with 2.0mm scopes (12° and 30°), single sheath system</i>

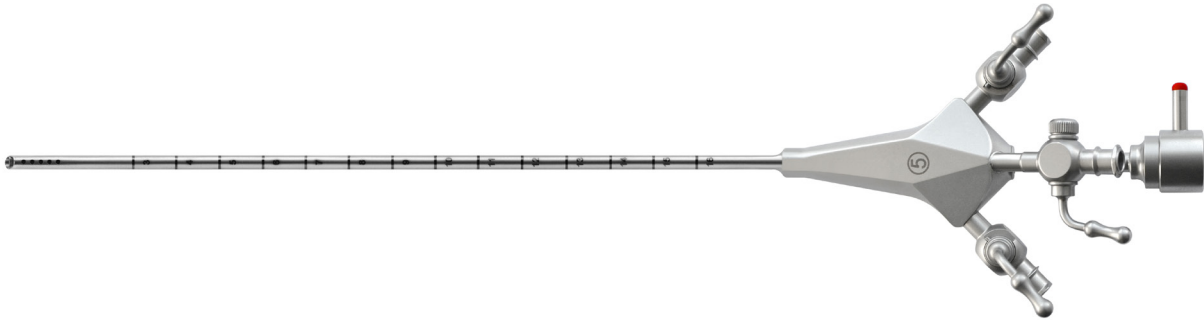

Bestell-Nr. Ordering no.	Farbmarkierung Colour code	
AN-001-311	Rot Red	HIGH-FLOW OP-Dauerspül-Hysteroskopschaft Ø 4.3mm , für 5 Ch. flexible und halbstarre Instrumente zur Verwendung mit 2.0mm Optiken (12° und 30°), Einschafsystem mit Absperrhahn <i>HIGH-FLOW OP-Continuous-flow-hysteroscope sheath Ø 4.3mm, for 5 Fr. flexible and semirigid instruments for use with 2.0mm scopes (12° and 30°), single sheath system with stopcock</i>

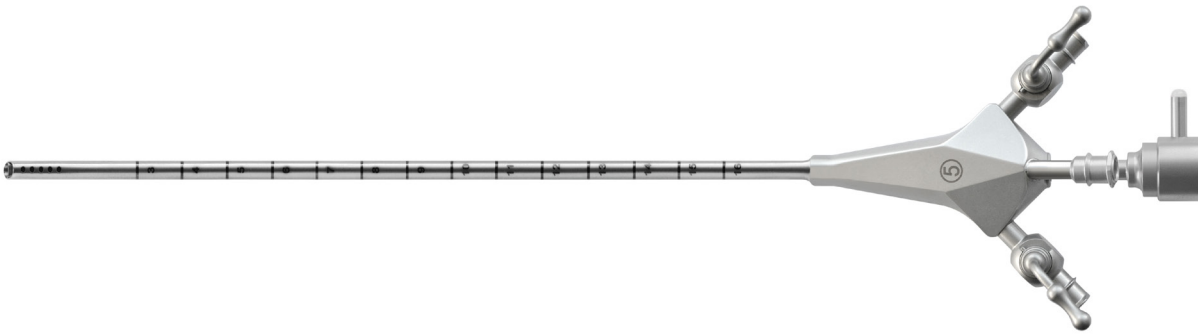

Bestell-Nr.
Ordering no.

Farbmarkierung
Colour code

AN-002-310

Weiss
 White

HIGH-FLOW OP-Dauerspül-Hysteroskopschaft **Ø 5.5mm**, für 5 Ch. flexible und halbstarre Instrumente zur Verwendung mit 2.9mm Optiken (12° und 30°), Einschafsystem
 HIGH-FLOW OP-Continuous-flow-hysteroscope sheath **Ø 5.5mm**, for 5 Fr. flexible and semirigid instruments for use with 2.9mm scopes (12° and 30°), single sheath system



Bestell-Nr.
Ordering no.

Farbmarkierung
Colour code











AN-002-311

Weiss
 White

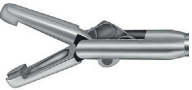



HIGH-FLOW OP-Dauerspül-Hysteroskopschaft **Ø 5.5mm**, für 5 Ch. flexible und halbstarre Instrumente zur Verwendung mit 2.9mm Optiken (12° und 30°), Einschafsystem mit Absperrhahn
 HIGH-FLOW OP-Continuous-flow-hysteroscope sheath **Ø 5.5mm**, for 5 Fr. flexible and semirigid instruments for use with 2.9mm scopes (12° and 30°), single sheath system with stopcock

Nutzlänge 400mm
Working length 400mm

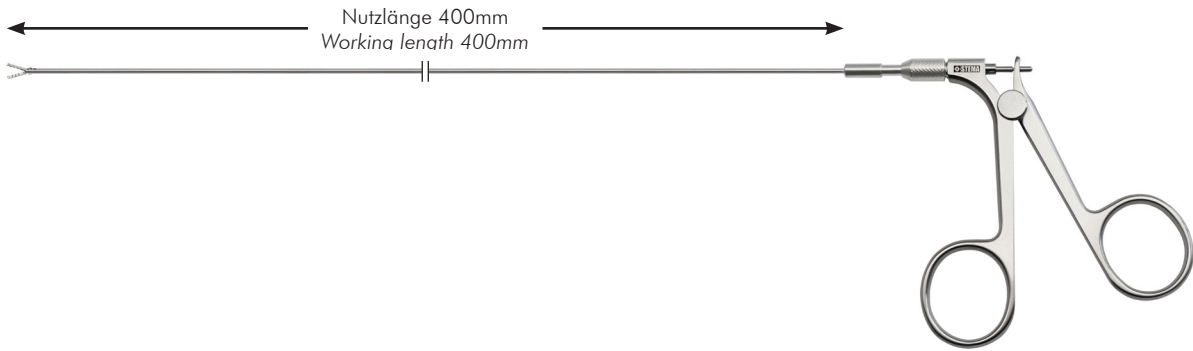

	Ømm	Charr. Fr.	Flexibel Flexible	Halbstarr Semi-rigid	Starr Rigid
 <p>Probeexzisionszange oval, doppelbeweglich <i>Biopsy forceps oval, double action</i></p>	1.0	3	AC-001-001	AC-001-201	AC-001-001-R
	1.6	5	AC-001-002	AC-001-202	AC-001-002-R
	2.1	6	AC-001-003	AC-001-203	AC-001-003-R
	2.3	7	AC-001-004	AC-001-204	AC-001-004-R
	3.0	9	AC-001-005	AC-001-205	AC-001-005-R
 <p>Probeexzisionszange oval, gezahnt, doppelbeweglich <i>Biopsy forceps oval, serrated, double action</i></p>	1.0	3	AC-002-001	AC-002-201	AC-002-001-R
	1.6	5	AC-002-002	AC-002-202	AC-002-002-R
	2.1	6	AC-002-003	AC-002-203	AC-002-003-R
	2.3	7	AC-002-004	AC-002-204	AC-002-004-R
	3.0	9	AC-002-005	AC-002-205	AC-002-005-R
 <p>Probeexzisionszange oval, gezahnt, Zähne ineinandergreifend, doppelbeweglich <i>Biopsy forceps oval, serrated, teeth interlock, double action</i></p>	1.6	5	AC-015-002	AC-015-202	AC-015-002-R
	2.1	6		AC-015-203	AC-015-003-R
	2.3	7	AC-015-004	AC-015-204	AC-015-004-R
 <p>Fremdkörperzange, doppelbeweglich <i>Grasping forceps, double action</i></p>	1.2	4	AC-017-001	AC-017-201	AC-017-001-R
	2.3	7	AC-017-004	AC-017-204	AC-017-004-R
 <p>Fasszange Alligatormaul, doppelbeweglich <i>Grasping forceps alligator jaw, double action</i></p>	1.0	3	AC-006-001	AC-006-201	AC-006-001-R
	1.2	4	AC-006-003	AC-006-203	AC-006-003-R
	1.6	5	AC-006-002	AC-006-202	AC-006-002-R
	2.3	7	AC-006-004	AC-006-204	AC-006-004-R
	3.0	9	AC-006-005	AC-006-205	AC-006-005-R
 <p>Fasszange DJ, doppelbeweglich <i>Grasping forceps DJ, double action</i></p>	2.3	7	AC-008-004	AC-008-204	AC-008-004-R
	3.0	9	AC-008-005	AC-008-205	AC-008-005-R
 <p>Fasszange gezahnt, doppelbeweglich <i>Grasping forceps teeth, double action</i></p>	1.2	4	AC-016-001	AC-016-201	AC-016-001-R
	1.6	5	AC-016-002	AC-016-202	AC-016-002-R
 <p>Fasszange Zähne ineinander, doppelbeweglich <i>Grasping forceps teeth interlock, double action</i></p>	1.6	5	AC-020-002	AC-020-202	AC-020-002-R
	2.3	7	AC-020-004	AC-020-204	AC-020-004-R
 <p>Fasszange Rattenzahn, doppelbeweglich <i>Grasping forceps rat tooth, double action</i></p>	1.0	3	AC-019-001	AC-019-201	AC-019-001-R
	1.6	5	AC-019-002	AC-019-202	AC-019-002-R
 <p>Fasszange für Steinstrasse, doppelbeweglich <i>Grasping forceps for stone street, double action</i></p>	1.2	4	AC-007-001	AC-007-201	AC-007-001-R
	1.6	5	AC-007-002	AC-007-202	AC-007-002-R
 <p>Fasszange für große Steine, doppelbeweglich <i>Grasping forceps for big stones, double action</i></p>	1.2	4	AC-009-001	AC-009-201	AC-009-001-R
	1.6	5	AC-009-002	AC-009-202	AC-009-002-R
	2.3	7	AC-009-004	AC-009-204	AC-009-004-R
 <p>Dreiarmsgreifer <i>3-Prongs retriever</i></p>	1.0	3	AC-012-001		
	1.6	5	AC-012-002		
	2.3	7	AC-012-004		



		Ømm	Charr. Fr.	Flexibel Flexible	Halbstarr Semi-rigid	Starr Rigid
	Schere gezahnt, doppelbeweglich Scissors serrated, double action	2.3	7	AC-005-004	AC-005-204	AC-005-004-R
	Schere, einfachbeweglich Scissors, single action	1.0	3	AC-003-000	AC-003-200	AC-003-000-R
		1.2	4	AC-003-001	AC-003-201	AC-003-001-R
		1.6	5	AC-003-002	AC-003-202	AC-003-002-R
		2.1	6	AC-003-003	AC-003-203	AC-003-003-R
		2.3	7	AC-003-004	AC-003-204	AC-003-004-R
		3.0	9	AC-003-005	AC-003-205	AC-003-005-R
	Ureter-Schlitzschere, einfachbeweglich Uretero slitting scissors, single action	1.2	4		AC-018-201	AC-018-001-R
		1.6	5		AC-018-202	AC-018-002-R
	Schere spitz, einfachbeweglich Scissors pointed, single action	1.6	5		AC-003-302	
		2.3	7		AC-003-304	
	Hakenschere, einfachbeweglich Hook scissors, single action	2.3	7	AC-004-004	AC-004-204	AC-004-004-R
		3.0	9	AC-004-005	AC-004-205	AC-004-005-R

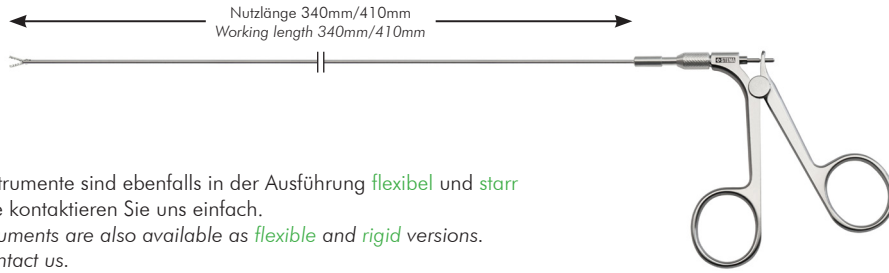

Info: Alle Instrumente sind ebenfalls in der Ausführung **flexibel** und **starr** erhältlich. Bitte kontaktieren Sie uns einfach.

Info: All instruments are also available as **flexible** and **rigid** versions. Please just contact us.

	Bestell-Nr. Ordering no.	Arbeitslänge Working length	Ømm	
	AC-001-502	340mm	1.6	Probeexzisionszange oval, doppelbeweglich, halbstarr <i>Biopsy forceps oval, double action, semi-rigid</i>
	AC-001-512	410mm	1.6	Probeexzisionszange oval, doppelbeweglich, halbstarr <i>Biopsy forceps oval, double action, semi-rigid</i>
	AC-001-504	340mm	2.3	Probeexzisionszange oval, doppelbeweglich, halbstarr <i>Biopsy forceps oval, double action, semi-rigid</i>
	AC-001-514	410mm	2.3	Probeexzisionszange oval, doppelbeweglich, halbstarr <i>Biopsy forceps oval, double action, semi-rigid</i>
	AC-002-502	340mm	1.6	Probeexzisionszange oval, gezahnt, doppelbeweglich, halbstarr <i>Biopsy forceps oval, serrated, double action, semi-rigid</i>
	AC-002-512	410mm	1.6	Probeexzisionszange oval, gezahnt, doppelbeweglich, halbstarr <i>Biopsy forceps oval, serrated, double action, semi-rigid</i>
	AC-010-502	340mm	1.6	Probeexzisionszange oval, gezahnt, einfachbeweglich, halbstarr <i>Biopsy forceps oval, serrated, single action, semi-rigid</i>
	AC-010-512	410mm	1.6	Probeexzisionszange oval, gezahnt, einfachbeweglich, halbstarr <i>Biopsy forceps oval, serrated, single action, semi-rigid</i>
	AC-010-504	340mm	2.3	Probeexzisionszange oval, gezahnt, einfachbeweglich, halbstarr <i>Biopsy forceps oval, serrated, single action, semi-rigid</i>
	AC-010-514	410mm	2.3	Probeexzisionszange oval, gezahnt, einfachbeweglich, halbstarr <i>Biopsy forceps oval, serrated, single action, semi-rigid</i>
	AC-014-502	340mm	1.6	Biopsiestanze, einfachbeweglich, halbstarr <i>Biopsy punch forceps, single action, semi-rigid</i>
	AC-014-512	410mm	1.6	Biopsiestanze, einfachbeweglich, halbstarr <i>Biopsy punch forceps, single action, semi-rigid</i>
	AC-014-504	340mm	2.3	Biopsiestanze, einfachbeweglich, halbstarr <i>Biopsy punch forceps, single action, semi-rigid</i>
	AC-014-514	410mm	2.3	Biopsiestanze, einfachbeweglich, halbstarr <i>Biopsy punch forceps, single action, semi-rigid</i>
	AC-006-502	340mm	1.6	Fasszange Alligatormaul, doppelbeweglich, halbstarr <i>Grasping forceps alligator jaw, double action, semi-rigid</i>
	AC-006-512	410mm	1.6	Fasszange Alligatormaul, doppelbeweglich, halbstarr <i>Grasping forceps alligator jaw, double action, semi-rigid</i>
	AC-006-504	340mm	2.3	Fasszange Alligatormaul, doppelbeweglich, halbstarr <i>Grasping forceps alligator jaw, double action, semi-rigid</i>
	AC-006-514	410mm	2.3	Fasszange Alligatormaul, doppelbeweglich, halbstarr <i>Grasping forceps alligator jaw, double action, semi-rigid</i>
	AC-003-502	340mm	1.6	Schere, einfachbeweglich, halbstarr <i>Scissors, single action, semi-rigid</i>
	AC-003-512	410mm	1.6	Schere, einfachbeweglich, halbstarr <i>Scissors, single action, semi-rigid</i>
	AC-003-504	340mm	2.3	Schere, einfachbeweglich, halbstarr <i>Scissors, single action, semi-rigid</i>
	AC-003-514	410mm	2.3	Schere, einfachbeweglich, halbstarr <i>Scissors, single action, semi-rigid</i>
	AC-003-602	340mm	1.6	Schere spitz, einfachbeweglich, halbstarr <i>Scissors pointed, single action, semi-rigid</i>
	AC-003-612	410mm	1.6	Schere spitz, einfachbeweglich, halbstarr <i>Scissors pointed, single action, semi-rigid</i>
	AC-003-604	340mm	2.3	Schere spitz, einfachbeweglich, halbstarr <i>Scissors pointed, single action, semi-rigid</i>
	AC-003-614	410mm	2.3	Schere spitz, einfachbeweglich, halbstarr <i>Scissors pointed, single action, semi-rigid</i>

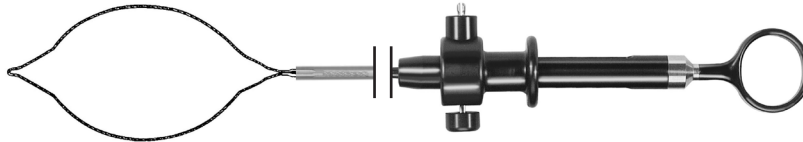













Bestell-Nr. Ordering no.	Charr. Fr.	
AF-002-002	5	Diathermie Schlinge komplett mit Griff, Arbeitslänge 60cm Diathermy loop complete with handle, working length 60cm
AF-002-001	5	Diathermie Schlinge, Schlinge mit Tubus , Arbeitslänge 60cm Diathermy loop, loop with tubus , working length 60cm
AF-002-004	7	Diathermie Schlinge komplett mit Griff, Arbeitslänge 60cm Diathermy loop complete with handle, working length 60cm
AF-002-003	7	Diathermie Schlinge, Schlinge mit Tubus , Arbeitslänge 60cm Diathermy loop, loop with tubus , working length 60cm
AF-002-010		Griff mit HF-Anschluss für Diathermie Schlingen Handle with HF connector for diathermy loops



Info: Sonderlängen für Diathermie Schlingen **auf Anfrage** erhältlich.
Info: Special lengths for diathermy loops available **on request**.







	Bestell-Nr. Ordering no.	Länge Length	Bestell-Nr. Ordering no.	Länge Length	Charr. Fr.	
	AD-003-003	530mm	AD-003-013	650mm	5	Schlingen-Elektrode flexibel, monop. Loop electrode flexible, monopolar
	AD-003-005	530mm	AD-003-015	650mm	7	
	AD-003-007	530mm	AD-003-017	650mm	9	
	AD-002-001	530mm	AD-002-011	650mm	3	Nadel-Elektrode flexibel, monopolar Needle electrode flexible, monopolar
	AD-002-002	530mm	AD-002-012	650mm	4	
	AD-002-003	530mm	AD-002-013	650mm	5	
	AD-002-005	530mm	AD-002-015	650mm	7	Knopf-Elektrode flexibel, monopolar Button electrode flexible, monopolar
	AD-001-001	530mm	AD-001-011	650mm	3	
	AD-001-002	530mm	AD-001-012	650mm	4	
	AD-001-003	530mm	AD-001-013	650mm	5	
	AD-001-004	530mm	AD-001-014	650mm	6	
	AD-001-005	530mm	AD-001-015	650mm	7	
	AD-001-006	530mm	AD-001-016	650mm	8	
	AD-001-007	530mm	AD-001-017	650mm	9	
AD-001-008	530mm	AD-001-018	650mm	10		

Anschluss Instrumentenseite <i>Connection instrument side</i>		Anschluss Geräteseite <i>Connection unit side</i>	
 		AD-010-001 / AD-010-006 	
		AD-010-002 / AD-010-007 	
		AD-010-003 / AD-010-008 	
		AD-010-004 / AD-010-005 	
		AD-010-024 	
 	AD-010-021	AD-010-021 AD-010-022 AD-010-023 	
	AD-010-022		
 	AD-010-023		
<p>Alle Kabel (außer AD-010-023) passen zu den flexiblen Elektroden AD-001-001 bis AD-003-018 <i>All cables (except AD-010-023) fit with the flexible electrodes AD-001-001 to AD-003-018</i></p>			





Bestell-Nr. Ordering no.	Länge Length	
AD-010-001 AD-010-006	3m 5m	Monopolares Anschlusskabel für Berchtold, Martin, Aesculap , Ø 4mm <i>Monopolar connecting cable for Berchtold, Martin, Aesculap, Ø 4mm</i>
AD-010-002 AD-010-007	3m 5m	Monopolares Anschlusskabel für Erbe, ACC/ICC, Storz , Ø 5mm <i>Monopolar connecting cable for Erbe, ACC/ICC, Storz, Ø 5mm</i>
AD-010-003 AD-010-008	3m 5m	Monopolares Anschlusskabel für Valleylab/Comned , Ø 8mm <i>Monopolar connecting cable for Valleylab/Comned, Ø 8mm</i>
AD-010-004 AD-010-005	3m 5m	Monopolares Anschlusskabel für Geräte mit 4mm Bananenstecker <i>Monopolar connecting cable for units with 4mm banana plug</i>
AD-010-024	4.5m	Monopolares Anschlusskabel für STEMA MASTER Geräte <i>Monopolar connecting cable for STEMA MASTER units</i>
AD-010-021	4.5m	Monopolares Anschlusskabel für STEMA MASTER Geräte mit SDS-Erkennung für STEMA , Ø 2mm <i>Monopolar connecting cable for STEMA MASTER units with SDS identification for STEMA, Ø 2mm</i>
AD-010-022	4.5m	Monopolares Anschlusskabel für STEMA MASTER Geräte mit SDS-Erkennung für STORZ , 90° Anschluss <i>Monopolar connecting cable for STEMA MASTER units with SDS identification for STORZ, 90° connection</i>
AD-010-023	4.5m	Monopolares Anschlusskabel für STEMA MASTER Geräte mit SDS-Erkennung für Olympus , Ø 3mm <i>Monopolar connecting cable for STEMA MASTER units with SDS identification for Olympus, Ø 3mm</i>



	Bestell-Nr. Ordering no.	Länge Length	Charr. Fr.	
	AD-004-001	360mm	5	Knopf-Elektrode flexibel, bipolar, Flachstecker <i>Button electrode flexible, bipolar, flat plug</i>
	AD-004-002	360mm	5	Nadel-Elektrode gewinkelt, flexibel, bipolar, Flachstecker <i>Needle electrode angled, flexible, bipolar, flat plug</i>
	AD-004-003	360mm	5	Nadel-Elektrode 90° gewinkelt, flexibel, bipolar, Flachstecker <i>Needle electrode 90° angled, flexible, bipolar, flat plug</i>
	AD-004-004	360mm	5	Nadel-Elektrode gerade, flexibel, bipolar, Flachstecker <i>Needle electrode straight, flexible, bipolar, flat plug</i>

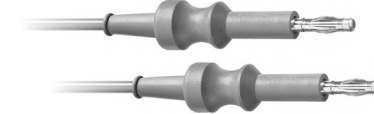

Info: Sonderlängen *auf Anfrage* erhältlich.
Info: *Special lengths available on request.*

Anschluss Flachstecker Instrumentenseite <i>Connection flat plug instrument side</i>	Anschluss Geräteseite <i>Connection unit side</i>
	<p>EK-010-010 / EK-010-011</p> 
	<p>EK-010-012 / EK-010-013</p> 
	<p>EK-010-014 / EK-010-015</p> 
	<p>EK-010-016 / EK-010-017</p> 
<p>Alle Kabel passen zu den flexiblen Elektroden AD-004-001 bis AD-004-004 <i>All cables fit with the flexible electrodes AD-004-001 to AD-004-004</i></p>	

Bestell-Nr. Ordering no.	Länge Length	
EK-010-010 EK-010-011	3m 5m	Bipolares Anschlusskabel, Flachstecker, für Berchtold, Martin, Aesculap <i>Bipolar connecting cable, flat plug, for Berchtold, Martin, Aesculap</i>
EK-010-012 EK-010-013	3m 5m	Bipolares Anschlusskabel Flachstecker, für Erbe, Storz <i>Bipolar connecting cable for Erbe, Storz</i>
EK-010-014 EK-010-015	3m 5m	Bipolares Anschlusskabel Flachstecker, für Valleylab/Conmed, EMC <i>Bipolar connecting cable, flat plug, for Valleylab/Conmed, EMC</i>
EK-010-016 EK-010-017	3m 5m	Bipolares Anschlusskabel Flachstecker, für Geräte mit 4mm Bananenstecker <i>Bipolar connecting cable, flat plug, for units with 4mm banana plug</i>



Bestell-Nr.
Ordering no.

AM-001-001	COHEN Intrauterionsonde, komplett mit 2 Portioadaptern <i>COHEN intrauterine probe, complete with 2 portio adapters</i>
AM-001-002	COHEN Intrauterionsonde, allein <i>COHEN intrauterine probe, only</i>
AM-001-003	Portio Adapter, klein <i>Portio adapter, small</i>
AM-001-004	Portio Adapter, gross <i>Portio adapter, large</i>

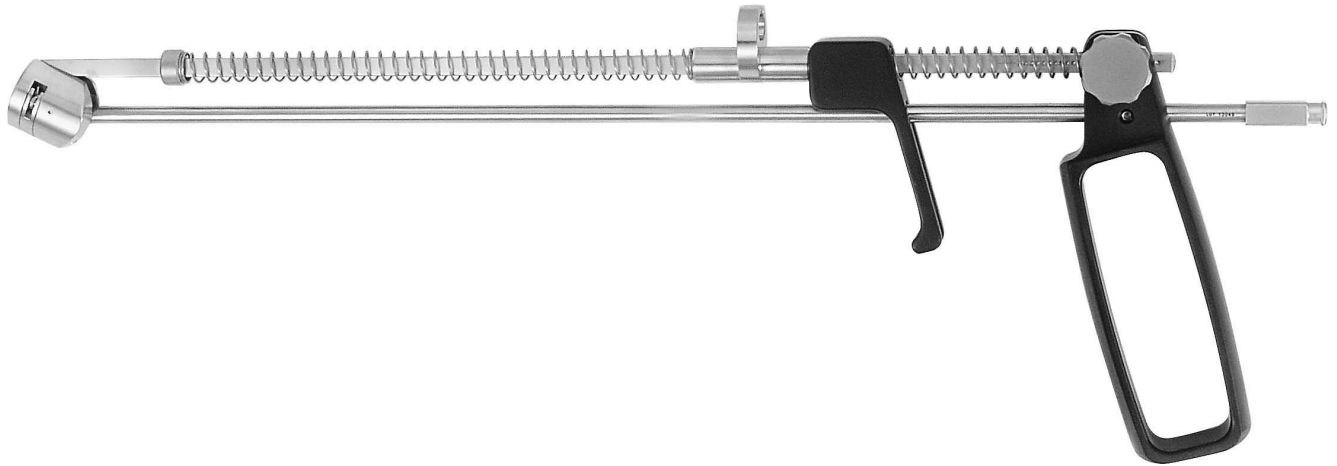

AM-002-003



AM-002-005



AM-002-007



AM-002-004



AM-002-006



AM-002-008

Bestell-Nr.
Ordering no.

AM-002-001	Uterusmanipulator komplett inkl. 6 Adaptern <i>Uterus manipulator complete incl. 6 adaptors</i>
AM-002-002	Uterusmanipulator, allein <i>Uterus manipulator, only</i>
AM-002-003	Adapter extra lang, Ø 10 x 100mm <i>Adaptor extra long, Ø 10 x 100mm</i>
AM-002-004	Adapter lang, Ø 8 x 80mm <i>Adaptor long, Ø 8 x 80mm</i>
AM-002-005	Adapter dünn, lang, Ø 3 x 55mm <i>Adaptor thin, long, Ø 3 x 55mm</i>
AM-002-006	Adapter dünn, kurz, Ø 3 x 45mm <i>Adaptor thin, short, Ø 3 x 45mm</i>
AM-002-007	Adapter mit Konus, lang <i>Adaptor with conus, long</i>
AM-002-008	Adapter mit Konus, kurz <i>Adaptor with conus, kurz</i>

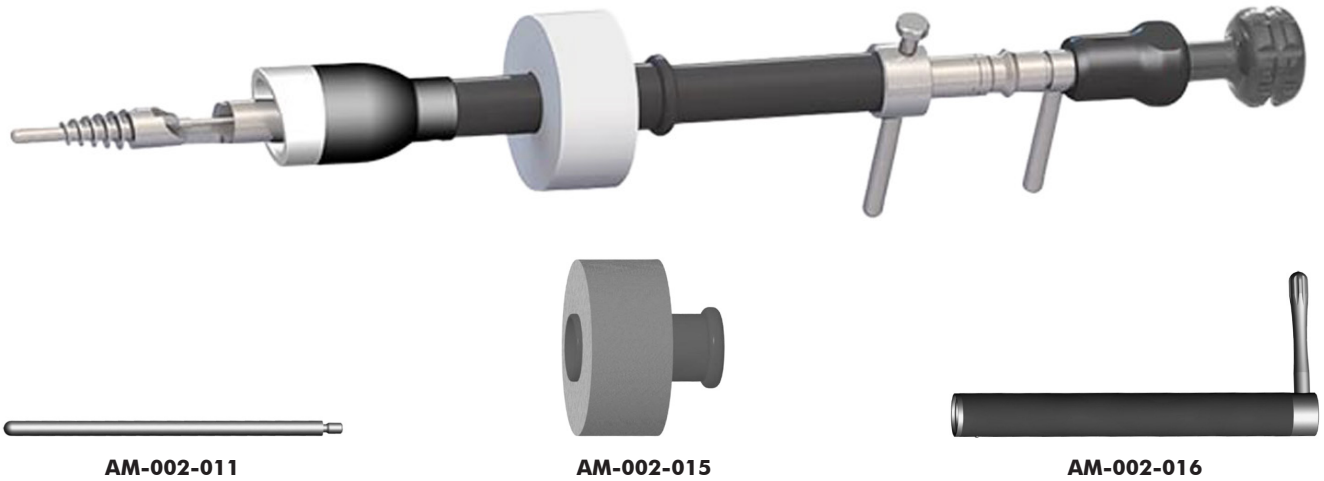

Bestell-Nr. Ordering no.	
AM-002-010	Uterusmanipulator-Set bestehend aus: Basisinstrument, 1 Valve, 5 Dichtungsaufsätzen und 11 Adaptoren (20-120mm) <i>Uterus manipulator set consisting of: Basic instrument, 1 valve, 5 sealing foams and 11 adaptors (20-120mm)</i>
AM-002-011	Adpaterset für AM-002-010 bestehend aus 11 Adaptoren (20-120mm) <i>Adapter set for AM-002-010 consisting of 11 adaptors (20-120mm)</i>
AM-002-012	Keramikaufsatz klein, Ø 24mm innen, Ø 32mm aussen (ohne Abbildung) <i>Ceramic cap small, Ø 24mm inner, Ø 32mm outer (wihtout illustration)</i>
AM-002-013	Keramikaufsatz mittel, Ø 28mm innen, Ø 36mm aussen (ohne Abbildung) <i>Ceramic cap medium, Ø 28mm inner, Ø 36mm outer (wihtout illustration)</i>
AM-002-014	Keramikaufsatz gross, Ø 36mm innen, Ø 40mm aussen (ohne Abbildung) <i>Ceramic cap large, Ø 36mm inner, Ø 40mm outer (wihtout illustration)</i>
AM-002-015	Schaumstoffaufsatz steril, 5 Stück/Box <i>Foam padded seal sterile, 5 pieces/box</i>
AM-002-016	Valvenrohr mit Handhebel, Ø 16mm <i>Valve tube with hand lever, Ø 16mm</i>
AM-002-018	Basisinstrument für Uterusmanipulator (ohne Abbildung) <i>Basic instrument for uterus manipulator (wihtout illustration)</i>



Bestell-Nr.
Ordering no.

AM-002-020	Uterusmanipulator komplett <i>Uterus manipulator complete</i>
AM-002-021	Handgriff drehbar <i>Handle rotatable</i>
AM-002-022	Spannschaft mit Überwurfhülse <i>Sheath with fixation nut</i>
AM-002-023	Innenrohr <i>Inner sheath</i>
AM-002-024	Schiebe- Fixationsschaft <i>Sliding and fixation sheath</i>
AM-002-025	Hülse 35mm <i>Tube 35mm</i>
AM-002-026	Hülse 40mm <i>Tube 40mm</i>
AM-002-027	Hülse 45mm <i>Tube 45mm</i>
AM-002-028	Cervix Krallenzange <i>Cervical tenaculum forceps</i>
AM-002-029	Intrauterin Adapter, 4 x 40mm <i>Intrauterin adapter, 4 x 40mm</i>
AM-002-030	Intrauterin Adapter, 5 x 50mm <i>Intrauterin adapter, 5 x 50mm</i>
AM-002-031	Intrauterin Adapter, 6 x 60mm <i>Intrauterin adapter, 6 x 60mm</i>
AM-002-032	Intrauterin Adapter, 7 x 70mm <i>Intrauterin adapter, 7 x 70mm</i>



Bestell-Nr.
Ordering no.

AM-004-001	Ø 5mm Myombohrer, Arbeitslänge 330mm <i>Ø 5mm myoma drill, working length 330mm</i>
AM-004-002	Ø 5mm Myombohrer, Arbeitslänge 420mm <i>Ø 5mm myoma drill, working length 420mm</i>
AM-004-004	Ø 10mm Myombohrer, Arbeitslänge 330mm <i>Ø 10mm myoma drill, working length 330mm</i>
AM-004-006	Ø 10mm Myombohrer, Arbeitslänge 420mm <i>Ø 10mm myoma drill, working length 420mm</i>



**Bestell-Nr.
Ordering no.**

AM-005-001 Ø 6mm Ringappikator für ersten Einstich, Arbeitslänge 328mm, komplett, zur Anwendung mit OP-Laparoskop
Ø 6mm ring applicator for first incision, working length 328mm, complete, used with operating laparoscope



**Bestell-Nr.
Ordering no.**

AM-005-002 Ø 6.5mm Ringappikator für zweiten Einstich, Arbeitslänge 288mm, komplett, zur Anwendung mit einer Trokarhülse
Ø 6.5mm ring applicator for second incision, working length 288mm, complete, used with trocar sleeve



AM-005-003



AM-005-004

**Bestell-Nr.
Ordering no.**

AM-005-003 Ladevorrichtung für Ringappikator
Loading device for ring applicator

AM-005-004 Konusteil
Conus piece

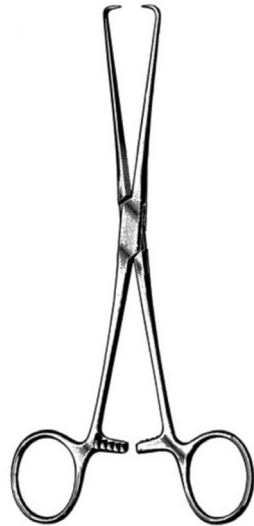

AJ-005-001



AJ-005-002

Bestell-Nr.
Ordering no.

AJ-005-001	Barret, Hakenzange, 18cm Barret, tenaculum forceps, 18cm
AJ-005-002	Pozzi, Hakenzange, kräftiges Modell, 25.5cm Pozzi, tenaculum forceps, strong pattern, 25.5cm

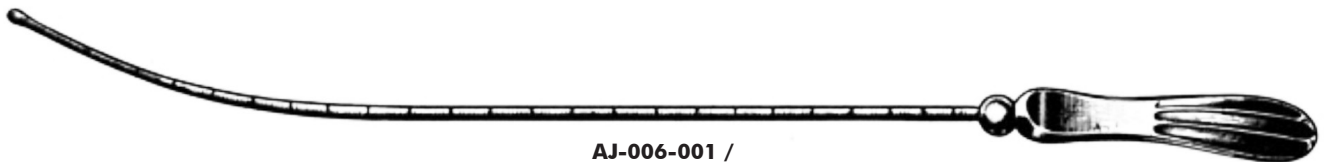

AJ-006-001 /
AJ-006-002



AJ-006-003 /
AJ-006-004

Bestell-Nr.
Ordering no.

AJ-006-001	Sims Uterussonde starr , 32cm Sims uterine probe rigid , 32cm
AJ-006-002	Sims Uterussonde biegsam , 32cm Sims uterine probe malleable , 32cm
AJ-006-003	Martin Uterussonde starr , 32cm Martin uterine probe rigid , 32cm
AJ-006-004	Martin Uterussonde biegsam , 32cm Martin uterine probe malleable , 32cm



**Bestell-Nr.
Ordering no.**

AJ-006-005	Novak Endometrium Biopsiekürette, Ø 1mm , 23cm Novak endometrium biopsy curette, Ø 1mm , 23cm
AJ-006-006	Novak Endometrium Biopsiekürette, Ø 2mm , 23cm Novak endometrium biopsy curette, Ø 2mm , 23cm
AJ-006-007	Novak Endometrium Biopsiekürette, Ø 3mm , 23cm Novak endometrium biopsy curette, Ø 3mm , 23cm
AJ-006-008	Novak Endometrium Biopsiekürette, Ø 4mm , 23cm Novak endometrium biopsy curette, Ø 4mm , 23cm



**Bestell-Nr.
Ordering no.**

AJ-006-012	Guttman Sekretlöffel, 26.5cm Guttman secretion spoon, 26.5cm
-------------------	---

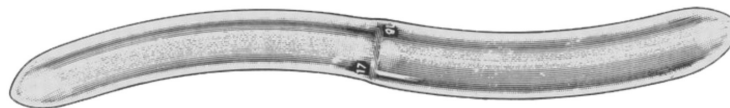

**Bestell-Nr.
Ordering no.**

AJ-003-078	Hegar Uterusdilatoren Set (8 Stück), doppelt, Ø 3/4mm - 17/18mm Hegar uterine dilatation set (8 pieces), double ended, Ø 3/4mm - 7/18mm
AJ-003-079	Hegar Uterusdilatoren Set (13 Stück), doppelt, Ø 1/2mm - 25/26mm Hegar uterine dilatation set (13 pieces), double ended, Ø 1/2mm - 25/26mm













**Bestell-Nr.
Ordering no.**

AM-003-001	Portio Adapter klein , für Schaftdurchmesser Ø 8.5mm Portio cervix small , for sheath diameter Ø 8.5mm
AM-003-002	Portio Adapter groß , für Schaftdurchmesser Ø 8.5mm Portio cervix large , for sheath diameter Ø 8.5mm



		Bestell-Nr. Ordering no.
		AM-006-000 Griff für Biopsiestanze <i>Handle for biopsy punch</i>
	AM-006-001 Tischler Biopsiestanze, 20cm <i>Tischler biopsy punch, 20cm</i>	AM-006-021 Aufsatz Tischler Biopsiestanze, 20cm <i>Insert Tischler biopsy punch, 20cm</i>
	AM-006-011 Tischler Biopsiestanze, 25cm <i>Tischler biopsy punch, 25cm</i>	AM-006-031 Aufsatz Tischler Biopsiestanze, 25cm <i>Insert Tischler biopsy punch, 25cm</i>
	AM-006-003 Mini-Tischler Biopsiestanze, 20cm <i>Mini Tischler biopsy punch, 20cm</i>	AM-006-023 Aufsatz Mini-Tischler Biopsiestanze, 20cm <i>Insert Mini Tischler biopsy punch, 20cm</i>
	AM-006-013 Mini-Tischler Biopsiestanze, 25cm <i>Mini Tischler biopsy punch, 25cm</i>	AM-006-033 Aufsatz Mini-Tischler Biopsiestanze, 25cm <i>Insert Mini Tischler biopsy punch, 25cm</i>
	AM-006-002 Kevorkian Biopsiestanze, 20cm <i>Kevorkian biopsy punch, 20cm</i>	AM-006-022 Aufsatz Kevorkian Biopsiestanze, 20cm <i>Insert Kevorkian biopsy punch, 20cm</i>
	AM-006-012 Kevorkian Biopsiestanze, 25cm <i>Kevorkian biopsy punch, 25cm</i>	AM-006-032 Aufsatz Kevorkian Biopsiestanze, 25cm <i>Insert Kevorkian biopsy punch, 25cm</i>

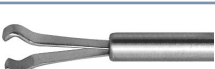

	Bestell-Nr. Ordering no.	
	ED-030-001	Ø 5mm T-förmige Fasszange mit Federgriff, 330mm Ø 5mm T-shaped grasping forceps with U-spring handle, 330mm
	ED-030-002	Ø 5mm Eileiter Fasszange mit Federgriff, 330mm Ø 5mm tube grasping forceps with U-spring handle, 330mm
	ED-030-003	Ø 5mm Mauszahn Fasszange mit Federgriff, 330mm Ø 5mm rat tooth grasping forceps with U-spring handle, 330mm
	ED-030-004	Ø 5mm Darmfasszange mit Federgriff, 330mm Ø 5mm Bowel grasping forceps with U-spring handle, 330mm
	ED-030-005	Ø 5mm runde Fasszange mit Federgriff, 330mm Ø 5mm round grasping forceps with U-spring handle, 330mm
	ED-030-006	Ø 5mm atraumatische Fasszange mit Federgriff, 330mm Ø 5mm atraumatic grasping forceps with U-spring handle, 330mm
	ED-030-007	Ø 5mm Fasszange 1 x 2 Zähne mit Federgriff, 330mm Ø 5mm grasping forceps 1 x 2 teeth with U-spring handle, 330mm
	ED-030-008	Ø 5mm atraumatische, gefensterterte Fasszange mit Federgriff, 330mm Ø 5mm atraumatic, fenestrated grasping forceps with U-spring handle, 330mm
	ED-030-009	Ø 5mm Gewebefasszange mit Federgriff, 330mm Ø 5mm tissue grasping forceps with U-spring handle, 330mm
	ED-030-010	Ø 5mm atraumatische Fasszange mit Federgriff, 330mm Ø 5mm atraumatic grasping forceps with U-spring handle, 330mm
	ED-030-011	Ø 5mm lange, atraumatische Fasszange mit Federgriff, 330mm Ø 5mm long, atraumatic forceps with U-spring handle, 330mm

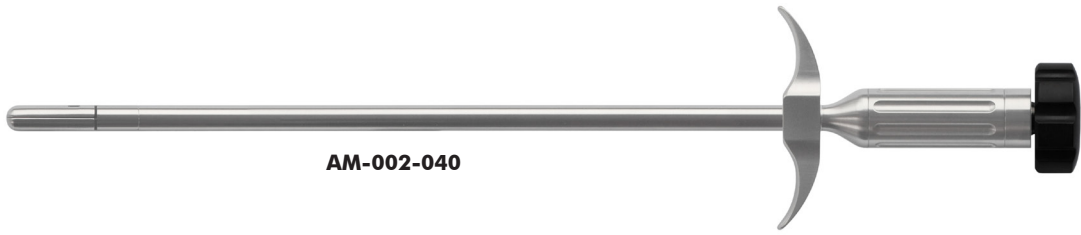

AM-002-040

Bestell-Nr.
Ordering no.

AM-002-040

LOWSLEY Retraktor, gerade, Ø 21.5 Charr., Arbeitslänge 280mm
LOWSLEY retractor, straight, Ø 21.5 Fr., working length 280mm

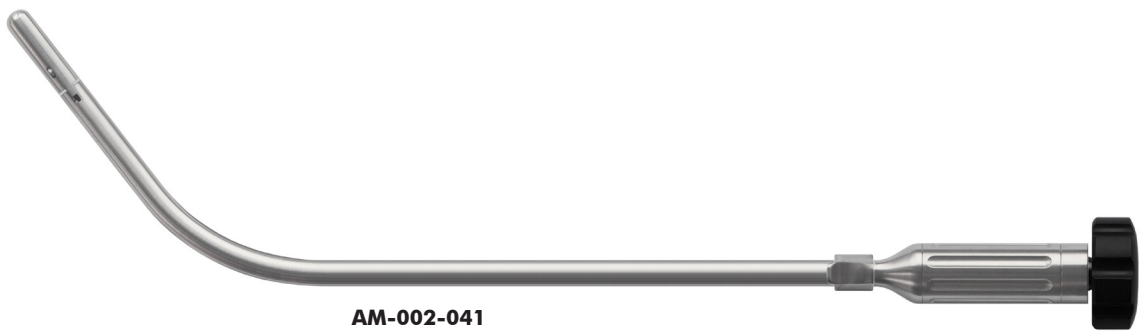

AM-002-041

Bestell-Nr.
Ordering no.

AM-002-041

LOWSLEY Retraktor, gebogen, Ø 21.5 Charr., Arbeitslänge 280mm
LOWSLEY retractor, curved, Ø 21.5 Fr., working length 280mm



AO-001-001
bis / to
AO-001-003

**Bestell-Nr.
Ordering no.**

AO-001-001	Amnioskop Tube konisch, mit Mandrin, Ø 12:24mm , NL 200mm <i>Amnioscope tube conical, with obturator, Ø 12:24mm, WL 200mm</i>
AO-001-002	Amnioskop Tube konisch, mit Mandrin, Ø 16:24mm , NL 200mm <i>Amnioscope tube conical, with obturator, Ø 16:24mm, WL 200mm</i>
AO-001-003	Amnioskop Tube konisch, mit Mandrin, Ø 20:24mm , NL 200mm <i>Amnioscope tube conical, with obturator, Ø 20:24mm, WL 200mm</i>

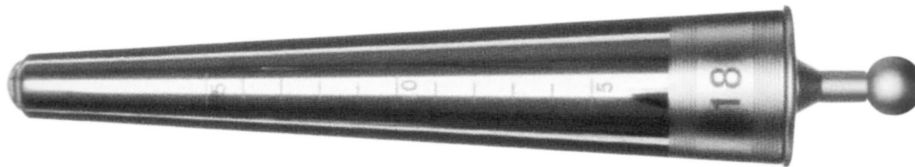

AO-001-007
bis / to
AO-001-009

**Bestell-Nr.
Ordering no.**

AO-001-007	Amnioskop Tube konisch für die Blutentnahme, mit Mandrin, Ø 14:40mm , NL 200mm <i>Amnioscope tube conical used for the micro blood extraction, with obturator, Ø 14:40mm, WL 200mm</i>
AO-001-008	Amnioskop Tube konisch für die Blutentnahme, mit Mandrin, Ø 18:40mm , NL 200mm <i>Amnioscope tube conical used for the micro blood extraction, with obturator, Ø 18:40mm, WL 200mm</i>
AO-001-009	Amnioskop Tube konisch für die Blutentnahme, mit Mandrin, Ø 32:40mm , NL 200mm <i>Amnioscope tube conical used for the micro blood extraction, with obturator, Ø 32:40mm, WL 200mm</i>



**Bestell-Nr.
Ordering no.**

AO-001-005	Kaltlichtklammer mit integriertem Kombi-Adapter passend für STEMA, Storz, ACMI, Wolf, Olympus <i>Fibre optic clamp with integrated adapter fitting STEMA, Storz, ACMI, Wolf, Olympus</i>
-------------------	---

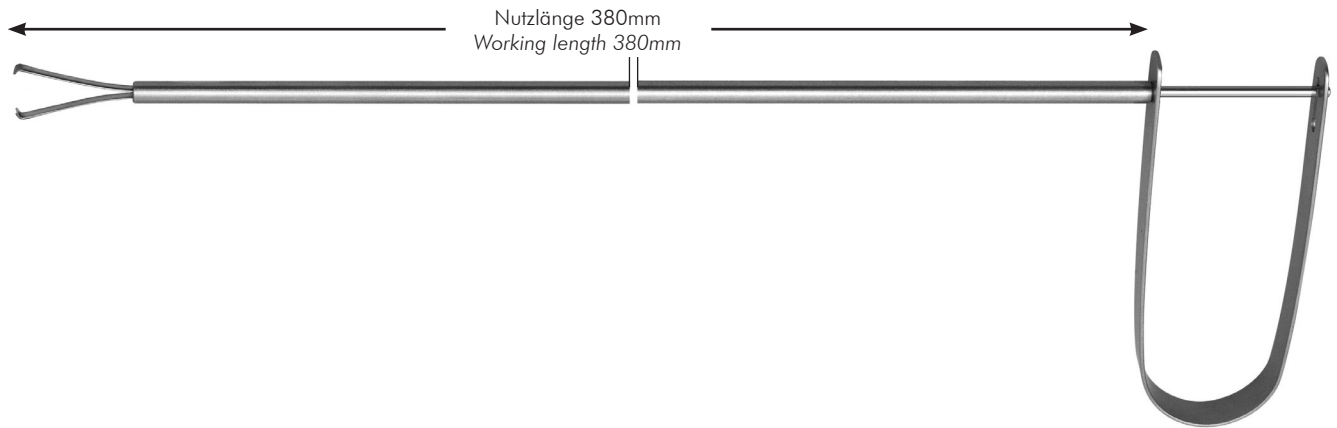

Bestell-Nr.
Ordering no.

GB-005-014 Tupferhalter, 38cm
Sponge holder, 38cm



Bestell-Nr.
Ordering no.

EI-003-001 Skalpellhalter, Ø 5mm, Arbeitslänge 38cm
Scalpel handle, Ø 5mm, working length 38cm



Bestell-Nr.
Ordering no.

EI-003-003 Klinge spitz, gerade
Pointed blade, straight

ZYSTO-URETHROSKOPIE-SET CYSTO-URETHROSCOPY SET

Komplettes Set bestehend aus:
Complete set consisting of:

Bestell-Nr. Ordering no.	
AA-002-013	HD Hysteroskop Ø 4.0mm, Blickwinkel 30°, autoklavierbar, 302mm HD Hysteroscope Ø 4.0mm, 30° viewing angle, autoclavable, 302mm
AB-001-004	Zysto-Urethroskopschaft 21 Charr. mit 2 starren Hähnen, mit Obturator Cysto-Urethroscope sheath 21 Fr. with 2 fixed stopcock, with obturator
AB-001-006	Zysto-Urethroskopschaft 25 Charr. mit 2 starren Hähnen, mit Obturator Cysto-Urethroscope sheath 25 Fr. with 2 fixed stopcock, with obturator
AB-003-003	Endoskopbrücke mit 1 Instrumentenkanal Endoscope bridge with 1 instrument channel
AB-003-007	Arbeitseinsatz mit Albarranhebel und 2 Instrumentenkanälen Working element with Albaran deflector and 2 instrument channels
AC-001-002	Probeexzisionszange flexibel, oval, doppelbeweglich, Ø 1.6mm, AL 40cm Biopsy forceps flexible, oval, double action, Ø 1.6mm, WL 40cm
AC-003-002	Schere flexibel, einfachbeweglich, Ø 1.6mm, AL 40cm Scissors flexible, single action, Ø 1.6mm, WL 40 cm
AC-006-004	Fasszange Alligatormaul flexibel, doppelbeweglich, Ø 2.3mm, AL 40cm Grasping forceps alligator jaw flexible, double action, Ø 2.3mm, WL 40cm
AD-001-003	Knopf-Elektrode flexibel, 5 Charr., monopolar, Länge 530mm Button electrode flexible, 5 Fr., monopolar, length 530mm
AD-002-003	Nadel-Elektrode flexibel, 5 Charr., monopolar, Länge 530mm Needle electrode flexible, 5 Fr., monopolar, length 530mm
AD-010-001	HF-Monopolar Anschlusskabel für Bertchold, Martin, Aesculap, Ø 4mm HF-Monopolar connecting cable for Bertchold, Martin, Aesculap, Ø 4mm
AF-001-008	Dormia Steinfänger, 5 Drähte, Ø 1.6mm, komplett mit Griff, AL 60cm Dormia stone extractor, 5 wires, Ø 1.6mm, complete with handle, WL 60cm
AB-004-001	Probeexzisionszange, doppelbeweglich Biopsy forceps, double action
AB-004-003	Fasszange, doppelbeweglich Grasping forceps, double action
AB-004-007	Optische Steinzange Optical stone punch
AJ-010-006	Schutzhülse zur Sterilisation und Aufbewahrung von Elektroden Protection sleeve for sterilization and storage of electrodes

RESEKTOSKOPIE-SET (MONOPOLAR)

RESECTOSCOPY SET (MONOPOLAR)

Komplettes Set bestehend aus:
 Complete set consisting of:

Bestell-Nr.	Ordering no.
AA-002-013	HD Zystoskop Ø 4.0mm, Blickwinkel 30°, autoklavierbar, 302mm HD Cystoscope Ø 4.0mm, 30° viewing angle, autoclavable, 302mm
AG-001-001	Arbeitselement für Resektoskope, passiv schneidend, Griff geschlossen <i>Working element used for resectoscopes, passive cutting, handle closed</i>
AH-001-301	Innenschaft 26 Charr. mit Keramikisolation, drehbar <i>Inner sheath 26 Fr. with ceramic isolation, rotatable</i>
AH-001-302	Außenschaft 26 Charr. mit Lochperforation, drehbar <i>Outer sheath 26 Fr. with perforation, rotatable</i>
AH-001-011	Standard Obturator, 24 Charr. <i>Standard obturator, 24 Fr.</i>
AE-001-001	Schlingenelektrode 30° abgewinkelt, 24 Charr. <i>Cutting loop electrode 30° angled, 24 Fr.</i>
AE-001-004	Kugelelektrode Ø 3mm, 24 Charr. <i>Rollerball electrode Ø 3mm, 24 Fr.</i>
AE-001-011	Rollenelektrode Ø 5mm, 24 Charr. <i>Rollerball electrode Ø 5mm, 24 Fr.</i>
AD-010-001	HF-Monopolar Anschlusskabel für Bertchold, Martin, Aesculap, Ø 4mm <i>HF-Monopolar connecting cable for Bertchold, Martin, Aesculap, Ø 4mm</i>
AJ-001-002	RECORD Spritze, 100 ml <i>RECORD syringe, 100 ml</i>
AJ-002-001	Ellik Evakuator, komplett <i>Ellik evacuator, complete</i>
AB-004-001	Probeexzisionszange, doppelbeweglich <i>Biopsy forceps, double action</i>
AB-004-003	Fasszange, doppelbeweglich <i>Grasping forceps, double action</i>
AB-004-008	Adapter für den Einsatz mit Resektoskopschäften <i>Adaptor for use with resectoscope sheaths</i>
AJ-010-006	Schutzhülse zur Sterilisation und Aufbewahrung von Elektroden <i>Protection sleeve for sterilization and storage of electrodes</i>

RESEKTOSKOPIE-SET (SALINE/BIPOLAR)
RESECTOSCOPY SET (SALINE/BIPOLAR)

Komplettes Set bestehend aus:
Complete set consisting of:

Bestell-Nr. Ordering no.	
AA-002-013	HD Zystoskop Ø 4.0mm, Blickwinkel 30°, autoklavierbar, 302mm HD Cystoscope Ø 4.0mm, 30° viewing angle, autoclavable, 302mm
AG-001-011	SALINE Arbeitselement für Resektoskope, passiv schneidend, Griff geschlossen SALINE working element used for resectoscopes, passive cutting, handle closed
AH-001-301	Innenschaft 26 Charr. mit Keramikisolation, drehbar Inner sheath 26 Fr. with ceramic isolation, rotatable
AH-001-302	Außenschaft 26 Charr. mit Lochperforation, drehbar Outer sheath 26 Fr. with perforation, rotatable
AH-001-011	Standard Obturator, 24 Charr. Standard obturator, 24 Fr.
AE-001-030	Schlingenelektrode 30° abgewinkelt, 24 Charr. Cutting loop electrode 30° angled, 24 Fr.
AE-001-034	Kugelelektrode Ø 3mm, 24 Charr. Rollerball electrode Ø 3mm, 24 Fr.
AE-001-043	Rollenelektrode Ø 5mm, 24 Charr. Rollerball electrode Ø 5mm, 24 Fr.
AD-010-011	Bipolares Anschlusskabel für Martin Maxium, Länge 4.5m Bipolar connecting cable for Martin Maxium, length 4.5m
AJ-001-002	RECORD Spritze, 100 ml RECORD syringe, 100 ml
AJ-002-001	Ellik Evakuator, komplett Ellik evacuator, complete
AB-004-001	Probeexzisionszange, doppelbeweglich Biopsy forceps, double action
AB-004-003	Fasszange, doppelbeweglich Grasping forceps, double action
AB-004-008	Adapter für den Einsatz mit Resektoskopschäften Adaptor for use with resectoscope sheaths
AJ-010-006	Schutzhülse zur Sterilisation und Aufbewahrung von Elektroden Protection sleeve for sterilization and storage of electrodes

OPTISCHES URETHROTOMIE-SET

OPTICAL URETHROTOMY SET

Komplettes Set bestehend aus:
 Complete set consisting of:

Bestell-Nr.	Ordering no.
AA-002-011	HD Zystoskop Ø 4.0mm, Blickwinkel 0°, autoklavierbar HD Cystoscope Ø 4.0mm, 0° viewing angle, autoclavable
AG-001-001	Arbeitselement für Resektoskope, passiv schneidend, Griff geschlossen <i>Working element used for resectoscopes, passive cutting, handle closed</i>
AI-001-001	Urethrotomschaft 21 Charr. mit Instrumentenkanal 5 Charr. <i>Urethrotome sheath 21 Fr. with instrument channel 5 Fr.</i>
AI-001-002	Zusatzschaft seitlich offen für AI-001-001 <i>Sheath open side for AI-001-001</i>
AI-001-004	Standardobturator für Urethrotomschaft 21 Charr. <i>Standardobturator for urethrotome sheath 21 Fr.</i>
AI-001-003	Endoskopbrücke mit 1 Instrumentenkanal <i>Endoscope bridge with 1 instrument channel</i>
AI-001-007	Strikturmesser gerade <i>Cold knife straight</i>
AI-001-008	Strikturmesser gerade mit Wellenschliff <i>Cold knife straight, wave shaped</i>
AI-001-009	Strikturmesser rund <i>Cold knife round</i>
AI-001-011	Strikturmesser hakenförmig <i>Cold knife hook shaped</i>
AJ-010-006	Schutzhülse zur Sterilisation und Aufbewahrung von Elektroden <i>Protection sleeve for sterilization and storage of electrodes</i>

DIAGNOSTIK HYSTEROSKOPIE-SET
DIAGNOSTIC HYSTEROSCOPY SET

Komplettes Set bestehend aus:
Complete set consisting of:

Bestell-Nr. Ordering no.	
AA-002-013	HD Hysteroskop Ø 4.0mm, Blickwinkel 30°, autoklavierbar, 302mm HD Hysteroscope Ø 4.0mm, 30° viewing angle, autoclavable, 302mm
AN-003-102	Innen-Diagnostik-Dauerspül-Hysteroskopschaft für 4mm / 30° Optik, Ø 5.4mm <i>Inner-diagnostic-continous-flow hysteroscope sheath for 4mm / 30° scope, Ø 5.4mm</i>
AN-003-103	Aussen-Diagnostik-Dauerspül-Hysteroskopschaft für 4mm Optiken, Ø 6.5mm <i>Outer-diagnostic-continous-flow hysteroscope sheath for 4mm scopes, Ø 6.5mm</i>
AN-003-104	Obturator für Diagnostik-Dauerspül-Hysteroskopschäfte für 4mm Optiken <i>Obturator used for diagnostic-continous-flow hysteroscope sheaths for 4mm scopes</i>

OPERATIVES HYSTEROSKOPIE-SET

OPERATIVE HYSTEROSCOPY SET

Komplettes Set bestehend aus:
 Complete set consisting of:

Bestell-Nr. Ordering no.	
AA-002-013	HD Hysteroskop Ø 4.0mm, Blickwinkel 30°, autoklavierbar, 302mm HD Hysteroscope Ø 4.0mm, 30° viewing angle, autoclavable, 302mm
AN-003-301	Innen-OP-Dauerspül-Hysteroskopschaft für 7 Charr. flexible und halbstarre Instrumente und für 4mm, 12°/30° Optik <i>Inner-OR-continuous-flow-hysteroscope sheath for 7 Fr. flexible and semirigid instruments and for 4mm, 12°/30° scopes</i>
AN-003-302	Aussen-OP-Dauerspül-Hysteroskopschaft für 7 Ch. flexible und halbstarre Instr. und für 4mm, 12°/30° Optik, Ø 7.8mm <i>Outer-OP-continuous-flow-hysteroscope sheath for 7 Fr. flexible and semirigid instr. and for 4mm, 12°/30° scopes, Ø 7.8mm</i>
AC-002-004	Probeexzisionszange oval gezahnt, flexibel, doppelbeweglich, Ø 2.3mm, AL 40cm <i>Biopsy forceps oval serrated, flexible, double action, Ø 2.3mm, WL 40cm</i>
AC-003-004	Schere flexibel, einfachbeweglich, Ø 2.3mm, AL 40cm <i>Scissors flexible, single action, Ø 2.3mm, WL 40 cm</i>
AC-006-004	Fasszange Alligatormaul flexibel, doppelbeweglich, Ø 2.3mm, AL 40cm <i>Grasping forceps alligator jaw flexible, double action, Ø 2.3mm, WL 40cm</i>
AD-001-005	Knopfelektrode flexibel, 7 Charr., monopolar, Länge 530mm <i>Button electrode flexible, 7 Fr., monopolar, length 530mm</i>
AD-002-005	Nadelelektrode flexibel, 7 Charr., monopolar, Länge 530mm <i>Needle electrode flexible, 7 Fr., monopolar, length 530mm</i>
AF-002-004	Diathermie Schlinge mit Tubus, Ø 2.3mm, komplett mit Griff, AL 50cm <i>Diathermy loop with tubus, Ø 2.3mm, complete with handle, WL 50 cm</i>

AMBULANTES ATRAUMATISCHES OP-HYSTEROSKOPIE-SET OUT-PATIENT ATRAUMATIC OR HYSTEROSCOPY SET

Komplettes Set bestehend aus:
Complete set consisting of:

Bestell-Nr. Ordering no.	
AA-003-012	HD Zystoskop Ø 2.9mm, Blickwinkel 30°, autoklavierbar HD Cystoscope Ø 2.9mm, 30° viewing angle, autoclavable
AN-002-301	Innen-OP-Dauerspül-Hysteroskopschaft für 5 Charr. flexible und halbstarre Instr. und für 2.7mm / 30° Optik, Ø 5.3mm Inner-OR-continuous-flow-hysteroscope sheath for 5 Fr. flexible and semirigid instr. and for 2.7mm / 30° scopes, Ø 5.3mm
AN-002-302	Aussen-OP-Dauerspül-Hysteroskopschaft für 5 Charr. flexible und halbstarre Instr. und für 2.7mm / 30° Optik, Ø 6.0mm Outer-OR-continuous-flow-hysteroscope sheath for 5 Fr. flexible and semirigid instr. and for 2.7mm / 30° scopes, Ø 6.0mm
AC-002-002	Probeexzisionszange oval gezahnt, flexibel, doppelbeweglich, Ø 1.6mm, AL 40cm Biopsy forceps oval serrated, flexible, double action, Ø 1.6mm, WL 40cm
AC-003-102	Schere flexibel, einfachbeweglich, isoliert, Ø 1.6mm, AL 40cm Scissors flexible, single action, insulated, Ø 1.6mm, WL 40cm
AC-006-002	Fasszange Alligatormaul, flexibel, doppelbeweglich, Ø 1.6mm, AL 40cm Grasping forceps alligator jaw, flexible, double action, Ø 1.6mm, WL 40cm
AD-001-003	Knopfelektrode flexibel, 5 Charr., monopolar, Länge 530mm Button electrode flexible, 5 Fr., monopolar, length 530mm
AD-002-003	Nadelelektrode flexibel, 5 Charr., monopolar, Länge 530mm Needle electrode flexible, 5 Fr., monopolar, length 530mm
AF-002-002	Diathermie Schlinge mit Tubus, Ø 1.6mm, komplett mit Griff, AL 50cm Diathermy loop with tubus, 5 Fr., complete with handle, WL 50cm



- Vollautomatisch
- Leistung angepasst an Indikation

- Full automatic
- Performance according to indication

Bestell-Nr.
Ordering no.

CG-001-001

Spül-Pumpe STEMA HYS - Technische Daten
Irrigation pump STEMA HYS - Technical data

Spüleleistung / Irrigation Max. 500 ml/Min. / Max. 500 ml/min.
 Druckbereich / Pressure range 10 - 200 mmHg / 10 - 200 mmHg
 Stromversorgung / Power supply 100 - 240 VAC oder 220 - 240 VAC, 50/60 Hz / 100 - 240 VAC or 220 - 240 VAC, 50/60 Hz
 Abmessungen / Dimensions 304 x 115 x 345mm (B x H x T) / 304 x 115 x 345mm (w x h x d)
 Gewicht / Weight 8,0 kg / 8,0 kg
 Klassifizierung / Classification 1/BF / 1/BF
 Zertifikate / Certificates CE, DIN EN 60601-1:2005 / CE, DIN EN 60601-1:2005

Im Lieferumfang enthalten
Deliver contains

Pumpe, Silikonschlauchset autoklavierbar (1), Sicherungen (2), Gebrauchsanweisung, Kabel: Anschluss (1)
 Pump, silicone tubing set autoclaveable (1), fuses (2), operating manual, cable: mains (1)

Bestell-Nr.
Ordering no.

CG-001-002 **STEMA URO** siehe CG-001-001 jedoch mit Spüleleistung max. 1.000 ml/Min. und Druckbereich 10 - 150 mmHg
 STEMA URO see CG-001-001 but with irrigation max. 1.000 ml/min. and pressure range 10 - 150 mmHg

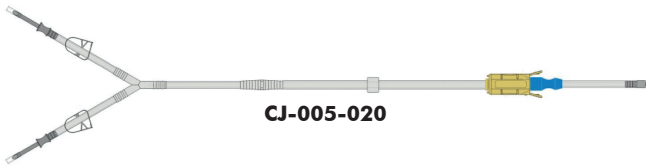

CJ-005-020

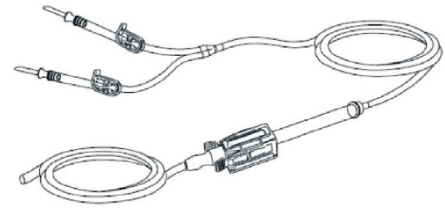

CJ-005-022



CJ-005-025



CJ-005-026



CJ-005-023

**Bestell-Nr.
Ordering no.**

CJ-005-020	Silikon Schlauchset für CG-001-001 und CG-001-002, autoklavierbar <i>Silicone tubing set for CG-001-001 and CG-001-002, autoclavable</i>
CJ-005-022	PVC Schlauchset für CG-001-001 und CG-001-002, Einmalgebrauch, 20 Stück <i>PVC tubing set for CG-001-001 and CG-001-002, single use, 20 pieces</i>
CJ-005-023	Meßkammer, für CG-001-001 und CG-001-002, autoklavierbar <i>Pressure measuring chamber for CG-001-001 and CG-001-002, autoclavable</i>
CJ-005-025	Euro Netzkabel für CG-001-001 und CG-001-002, 2m <i>Euro mains cable for CG-001-001 and CG-001-002, 2m</i>
CJ-005-026	Netzsicherung T 400ma für CG-001-001 und CG-001-002, 5 x 20, 10 Stück <i>Fuse T 400ma for CG-001-001 and CG-001-002, 5 x 20, 10 pieces</i>



Info: Für weitere Modelle fordern Sie bitte unseren Katalog für **Geräte** an.
Info: For further models please kindly request our catalogue for **units**.

GERÄTE UNITS



Bestell-Nr. Ordering no.	Seite Page	Bestell-Nr. Ordering no.	Seite Page	Bestell-Nr. Ordering no.	Seite Page	Bestell-Nr. Ordering no.	Seite Page
AA-001-001	8	AA-002-004-W	8	AA-003-012	16	AA-006-080	62
AA-001-001	122	AA-002-004-W	122	AA-003-012	41	AA-006-080	71
AA-001-001	124	AA-002-011	9	AA-003-012	42	AA-006-080	73
AA-001-001	125	AA-002-011	65	AA-003-012	43	AA-006-081	62
AA-001-001	127	AA-002-011	98	AA-003-012	48	AA-006-081	71
AA-001-002	8	AA-002-011	123	AA-003-012	50	AA-006-081	73
AA-001-002	122	AA-002-011-W	9	AA-003-012	52	AA-006-081	77
AA-001-003	8	AA-002-011-W	123	AA-003-012	123	AA-006-100	80
AA-001-003	41	AA-002-012	9	AA-003-012	129	AA-006-101	80
AA-001-003	42	AA-002-012	123	AA-003-012-W	9	AA-006-102	80
AA-001-003	43	AA-002-012-W	123	AA-003-012-W	16	AA-007-001	81
AA-001-003	122	AA-002-013	9	AA-003-012-W	123	AA-007-002	81
AA-001-003	125	AA-002-013	15	AA-003-014	9	AA-007-003	84
AA-001-003	126	AA-002-013	54	AA-003-014	123	AA-007-004	84
AA-001-003	127	AA-002-013	98	AA-004-001	100	AA-007-005	84
AA-001-004	8	AA-002-013	123	AA-004-001	124	AA-007-006	86
AA-001-004	122	AA-002-013	128	AA-004-001	125	AA-007-007	86
AA-001-011	9	AA-002-013	129	AA-004-001	126	AA-007-008	86
AA-001-011	123	AA-002-013-W	9	AA-004-002	100	AA-007-009	87
AA-001-012	9	AA-002-013-W	123	AA-004-002	124	AA-007-011	81
AA-001-012	123	AA-002-014	9	AA-004-002	125	AA-007-012	81
AA-001-013	9	AA-002-014	123	AA-004-002	126	AA-007-013	85
AA-001-013	41	AA-002-014-W	9	AA-004-002	129	AA-007-014	85
AA-001-013	42	AA-002-021	10	AA-004-011	100	AA-007-015	85
AA-001-013	43	AA-002-021	65	AA-004-011	102	AA-007-016	84
AA-001-013	123	AA-002-022	10	AA-004-011	106	AA-007-017	84
AA-001-014	9	AA-002-023	10	AA-004-011	110	AA-007-018	84
AA-001-014	123	AA-002-023	15	AA-004-012	100	AA-007-019	84
AA-002-001	8	AA-002-023	54	AA-004-012	102	AA-007-021	81
AA-002-001	65	AA-002-023	128	AA-004-013	100	AA-007-022	86
AA-002-001	98	AA-002-024	10	AA-004-013	101	AA-007-023	86
AA-002-001	122	AA-003-001	8	AA-004-014	100	AA-007-024	86
AA-002-001	125	AA-003-001	69	AA-004-014	101	AA-007-025	86
AA-002-001	126	AA-003-001	122	AA-005-001	100	AA-007-026	86
AA-002-001	127	AA-003-001	125	AA-005-001	103	AA-007-027	86
AA-002-001	130	AA-003-001	126	AA-005-001	106	AA-007-028	87
AA-002-001-W	8	AA-003-001	127	AA-005-001	110	AA-007-029	87
AA-002-001-W	122	AA-003-002	8	AA-005-003	100	AA-007-030	85
AA-002-002	8	AA-003-002	16	AA-005-003	103	AA-007-031	85
AA-002-002	122	AA-003-002	41	AA-005-004	100	AA-007-032	85
AA-002-002	125	AA-003-002	42	AA-005-004	103	AA-007-033	85
AA-002-002	126	AA-003-002	43	AA-006-001	71	AA-007-034	85
AA-002-002	127	AA-003-002	48	AA-006-002	71	AA-007-035	85
AA-002-002	130	AA-003-002	50	AA-006-004	71	AA-007-036	84
AA-002-003	8	AA-003-002	52	AA-006-005	71	AA-007-037	84
AA-002-003	15	AA-003-002	122	AA-006-006	73	AA-007-041	83
AA-002-003	54	AA-003-002	125	AA-006-011	73	AA-007-042	83
AA-002-003	98	AA-003-002	126	AA-006-012	62	AA-007-043	82
AA-002-003	122	AA-003-002	127	AA-006-012	73	AA-007-044	82
AA-002-003	125	AA-003-002	129	AA-006-021	71	AA-007-045	83
AA-002-003	126	AA-003-002-W	8	AA-006-022	71	AA-007-046	83
AA-002-003	127	AA-003-002-W	122	AA-006-031	73	AA-007-047	82
AA-002-003	128	AA-003-003	8	AA-006-032	73	AA-007-048	82
AA-002-003	129	AA-003-003	122	AA-006-034	73	AA-007-049	83
AA-002-003	130	AA-003-004	8	AA-006-050	79	AA-007-050	83
AA-002-003-W	8	AA-003-004	122	AA-006-051	79	AA-007-051	82
AA-002-003-W	122	AA-003-011	9	AA-006-052	79	AA-007-052	82
AA-002-004	8	AA-003-011	69	AA-006-053	79	AA-007-053	83
AA-002-004	122	AA-003-011	123	AA-006-069	77	AA-007-054	83
AA-002-004	130	AA-003-012	9	AA-006-070	77	AA-007-055	82

Bestell-Nr. Ordering no.	Seite Page	Bestell-Nr. Ordering no.	Seite Page	Bestell-Nr. Ordering no.	Seite Page	Bestell-Nr. Ordering no.	Seite Page
AA-007-056	82	AB-003-004	14	AB-006-063	74	AC-001-005	20
AA-007-060	28	AB-003-005	103	AB-006-064	74	AC-001-005	133
AA-007-061	28	AB-003-006	14	AB-006-065	74	AC-001-005-OT	22
AA-007-062	28	AB-003-007	14	AB-006-066	74	AC-001-005-R	20
AA-008-002	29	AB-003-008	14	AB-006-067	74	AC-001-005-R	133
AA-008-003	88	AB-003-009	14	AB-006-068	74	AC-001-005-T	22
AA-008-100	30	AB-003-010	17	AB-006-100	79	AC-001-006-OT	22
AA-008-100	89	AB-003-011	17	AB-006-101	79	AC-001-006-T	22
AA-008-102	30	AB-003-012	17	AB-006-102	79	AC-001-010-OT	92
AA-008-102	89	AB-003-013	17	AB-006-110	79	AC-001-010-T	92
AA-008-103	30	AB-003-014	17	AB-006-111	79	AC-001-011	90
AA-008-103	89	AB-003-015	14	AB-006-112	79	AC-001-011-OT	92
AA-008-104	30	AB-003-020	17	AB-006-115	79	AC-001-011-R	90
AA-008-104	89	AB-004-001	18	AB-006-170	77	AC-001-011-T	92
AA-008-105	30	AB-004-002	18	AB-006-171	77	AC-001-012	90
AA-008-105	89	AB-004-003	18	AB-006-242	78	AC-001-012-OT	92
AB-001-000	16	AB-004-004	18	AB-006-243	78	AC-001-012-R	90
AB-001-001	103	AB-004-005	18	AB-006-244	78	AC-001-012-T	92
AB-001-001-11	102	AB-004-006	18	AB-006-245	78	AC-001-013	90
AB-001-001-13	103	AB-004-007	19	AB-006-246	78	AC-001-013-R	90
AB-001-001-7	101	AB-004-008	18	AB-006-342	78	AC-001-014	90
AB-001-001-9	102	AB-004-009	19	AB-006-343	78	AC-001-014-OT	92
AB-001-002	12	AB-004-009-QL	19	AB-006-344	78	AC-001-014-R	90
AB-001-003	12	AB-004-010	18	AB-006-345	78	AC-001-014-T	92
AB-001-004	12	AB-004-010-QL	62	AB-006-346	78	AC-001-015	90
AB-001-005	12	AB-004-011	99	AB-006-442	78	AC-001-015-OT	92
AB-001-006	12	AB-004-012	99	AB-006-443	78	AC-001-015-R	90
AB-001-007	16	AB-006-001	72	AB-006-444	78	AC-001-015-T	92
AB-001-010	13	AB-006-002	72	AB-006-445	78	AC-001-021	104
AB-001-011	103	AB-006-003	72	AB-006-446	78	AC-001-201	20
AB-001-011-11	102	AB-006-004	72	AB-007-001	58	AC-001-201	133
AB-001-011-7	101	AB-006-005	72	AB-007-002	58	AC-001-201-OT	23
AB-001-011-9	102	AB-006-006	72	AB-007-003	58	AC-001-201-T	23
AB-001-012	13	AB-006-007	72	AB-007-004	59	AC-001-202	20
AB-001-013	13	AB-006-008	72	AB-007-005	59	AC-001-202	133
AB-001-014	13	AB-006-011	75	AB-007-006	59	AC-001-202-OT	23
AB-001-015	13	AB-006-012	75	AB-007-007	59	AC-001-202-T	23
AB-001-016	13	AB-006-013	75	AB-007-008	58	AC-001-203	20
AB-001-022	13	AB-006-020	75	AC-001-001	20	AC-001-203	133
AB-001-023	13	AB-006-021	75	AC-001-001	133	AC-001-203-OT	23
AB-001-024	13	AB-006-022	75	AC-001-001-OT	22	AC-001-203-T	23
AB-001-025	13	AB-006-023	75	AC-001-001-R	20	AC-001-204	20
AB-001-026	13	AB-006-024	75	AC-001-001-R	133	AC-001-204	133
AB-001-040	15	AB-006-025	75	AC-001-001-T	22	AC-001-204-OT	23
AB-001-041	15	AB-006-026	75	AC-001-002	20	AC-001-204-T	23
AB-001-042	15	AB-006-027	75	AC-001-002	133	AC-001-205	20
AB-001-043	15	AB-006-040	76	AC-001-002-OT	22	AC-001-205	133
AB-002-001	12	AB-006-041	76	AC-001-002-R	20	AC-001-206-OT	23
AB-002-002	12	AB-006-042	76	AC-001-002-R	133	AC-001-206-T	23
AB-002-003	12	AB-006-043	76	AC-001-002-T	22	AC-001-210-OT	93
AB-002-004	12	AB-006-044	76	AC-001-003	20	AC-001-210-T	93
AB-002-005	12	AB-006-045	76	AC-001-003	133	AC-001-211	90
AB-002-010	98	AB-006-046	76	AC-001-003-R	20	AC-001-211-OT	93
AB-002-011	98	AB-006-047	76	AC-001-003-R	133	AC-001-211-T	93
AB-002-012	98	AB-006-048	76	AC-001-004	20	AC-001-212	90
AB-002-013	98	AB-006-049	76	AC-001-004	133	AC-001-212-OT	93
AB-002-014	99	AB-006-050	76	AC-001-004-OT	22	AC-001-212-T	93
AB-003-001	103	AB-006-051	76	AC-001-004-R	20	AC-001-213	90
AB-003-002	14	AB-006-061	74	AC-001-004-R	133	AC-001-214	90
AB-003-003	14	AB-006-062	74	AC-001-004-T	22	AC-001-214-OT	93

Bestell-Nr. Ordering no.	Seite Page	Bestell-Nr. Ordering no.	Seite Page	Bestell-Nr. Ordering no.	Seite Page	Bestell-Nr. Ordering no.	Seite Page
AC-001-214-T	93	AC-003-000-R	134	AC-003-201-T	23	AC-004-005-R	134
AC-001-215	90	AC-003-000-T	22	AC-003-202	21	AC-004-005-T	22
AC-001-215-OT	93	AC-003-001	21	AC-003-202	134	AC-004-014	91
AC-001-215-T	93	AC-003-001	134	AC-003-202-OT	23	AC-004-014-OT	92
AC-001-221	104	AC-003-001-OT	22	AC-003-202-T	23	AC-004-014-R	91
AC-001-502	135	AC-003-001-R	21	AC-003-203	21	AC-004-014-T	92
AC-001-504	135	AC-003-001-R	134	AC-003-203	134	AC-004-015	91
AC-001-512	135	AC-003-001-T	22	AC-003-204	21	AC-004-015-OT	92
AC-001-514	135	AC-003-002	21	AC-003-204	134	AC-004-015-R	91
AC-002-001	20	AC-003-002	134	AC-003-204-OT	23	AC-004-015-T	92
AC-002-001	133	AC-003-002-OT	22	AC-003-204-T	23	AC-004-204	21
AC-002-001-R	20	AC-003-002-R	21	AC-003-205	21	AC-004-204	134
AC-002-001-R	133	AC-003-002-R	134	AC-003-205	134	AC-004-204-OT	23
AC-002-002	20	AC-003-002-T	22	AC-003-205-OT	23	AC-004-204-T	23
AC-002-002	133	AC-003-003	21	AC-003-205-T	23	AC-004-205	21
AC-002-002-R	20	AC-003-003	134	AC-003-210	91	AC-004-205	134
AC-002-002-R	133	AC-003-003-R	21	AC-003-210-OT	93	AC-004-205-OT	23
AC-002-003	20	AC-003-003-R	134	AC-003-210-T	93	AC-004-205-T	23
AC-002-003	133	AC-003-004	21	AC-003-211	91	AC-004-214	91
AC-002-003-R	20	AC-003-004	134	AC-003-211-OT	93	AC-004-214-OT	93
AC-002-003-R	133	AC-003-004-OT	22	AC-003-211-T	93	AC-004-214-T	93
AC-002-004	20	AC-003-004-R	21	AC-003-212	91	AC-004-215	91
AC-002-004	133	AC-003-004-R	134	AC-003-212-OT	93	AC-004-215-OT	93
AC-002-004-R	20	AC-003-004-T	22	AC-003-212-OT	93	AC-004-215-T	93
AC-002-004-R	133	AC-003-005	21	AC-003-212-T	93	AC-004-622-OT	93
AC-002-005	20	AC-003-005	134	AC-003-212-T	93	AC-004-622-T	93
AC-002-005	133	AC-003-005-OT	22	AC-003-213	91	AC-004-624-OT	93
AC-002-005-R	20	AC-003-005-R	21	AC-003-214	91	AC-004-624-T	93
AC-002-005-R	133	AC-003-005-R	134	AC-003-214-OT	93	AC-005-004	21
AC-002-011	90	AC-003-005-T	22	AC-003-214-T	93	AC-005-004	134
AC-002-011-R	90	AC-003-010	91	AC-003-215	91	AC-005-004-R	21
AC-002-012	90	AC-003-010-OT	92	AC-003-215-OT	93	AC-005-004-R	134
AC-002-012-R	90	AC-003-010-R	91	AC-003-215-T	93	AC-005-014	91
AC-002-013	90	AC-003-010-T	92	AC-003-221	104	AC-005-014-R	91
AC-002-013-R	90	AC-003-011	91	AC-003-402-OT	22	AC-005-204	21
AC-002-014	90	AC-003-011-OT	92	AC-003-402-T	22	AC-005-204	134
AC-002-014-R	90	AC-003-011-R	91	AC-003-412-OT	92	AC-005-214	91
AC-002-015	90	AC-003-011-T	92	AC-003-412-T	92	AC-006-001	20
AC-002-015-R	90	AC-003-012	91	AC-003-502	135	AC-006-001	133
AC-002-201	20	AC-003-012-OT	92	AC-003-504	135	AC-006-001-OT	22
AC-002-201	133	AC-003-012-R	91	AC-003-512	135	AC-006-001-R	20
AC-002-202	20	AC-003-012-T	92	AC-003-514	135	AC-006-001-R	133
AC-002-202	133	AC-003-013	91	AC-003-602	135	AC-006-001-T	22
AC-002-203	20	AC-003-013-R	91	AC-003-604	135	AC-006-002	20
AC-002-203	133	AC-003-014	91	AC-003-612	135	AC-006-002	133
AC-002-204	20	AC-003-014-OT	92	AC-003-612-OT	23	AC-006-002-OT	22
AC-002-204	133	AC-003-014-R	91	AC-003-612-T	23	AC-006-002-R	20
AC-002-205	20	AC-003-014-T	92	AC-003-614	135	AC-006-002-R	133
AC-002-205	133	AC-003-015	91	AC-003-614-OT	23	AC-006-002-T	22
AC-002-211	90	AC-003-015-OT	92	AC-003-614-T	23	AC-006-003	20
AC-002-212	90	AC-003-015-R	91	AC-004-004	21	AC-006-003	133
AC-002-213	90	AC-003-015-T	92	AC-004-004	134	AC-006-003-OT	22
AC-002-214	90	AC-003-021	104	AC-004-004-OT	22	AC-006-003-R	20
AC-002-215	90	AC-003-200	21	AC-004-004-R	21	AC-006-003-R	133
AC-002-502	135	AC-003-200	134	AC-004-004-R	134	AC-006-003-T	22
AC-002-512	135	AC-003-200-OT	23	AC-004-004-T	22	AC-006-004	20
AC-003-000	21	AC-003-200-T	23	AC-004-005	21	AC-006-004	133
AC-003-000	134	AC-003-201	21	AC-004-005	134	AC-006-004-OT	22
AC-003-000-OT	22	AC-003-201	134	AC-004-005-OT	22	AC-006-004-R	20
AC-003-000-R	21	AC-003-201-OT	23	AC-004-005-R	21	AC-006-004-R	133

Bestell-Nr. Ordering no.	Seite Page	Bestell-Nr. Ordering no.	Seite Page	Bestell-Nr. Ordering no.	Seite Page	Bestell-Nr. Ordering no.	Seite Page
AC-006-004-T	22	AC-006-215	90	AC-009-001	20	AC-014-212-OT	93
AC-006-005	20	AC-006-215-OT	93	AC-009-001	133	AC-014-212-T	93
AC-006-005	133	AC-006-215-T	93	AC-009-001-OT	22	AC-014-502	135
AC-006-005-OT	22	AC-006-221	104	AC-009-001-R	20	AC-014-504	135
AC-006-005-R	20	AC-006-502	135	AC-009-001-R	133	AC-014-512	135
AC-006-005-R	133	AC-006-504	135	AC-009-001-T	22	AC-014-514	135
AC-006-005-T	22	AC-006-512	135	AC-009-002	20	AC-015-002	20
AC-006-011	90	AC-006-514	135	AC-009-002	133	AC-015-002	133
AC-006-011-OT	92	AC-007-001	20	AC-009-002-OT	22	AC-015-002-R	20
AC-006-011-R	90	AC-007-001	133	AC-009-002-R	20	AC-015-002-R	133
AC-006-011-T	92	AC-007-001-OT	22	AC-009-002-R	133	AC-015-003-R	20
AC-006-012	90	AC-007-001-R	20	AC-009-002-T	22	AC-015-003-R	133
AC-006-012-OT	92	AC-007-001-R	133	AC-009-004	20	AC-015-004	20
AC-006-012-R	90	AC-007-001-T	22	AC-009-004	133	AC-015-004	133
AC-006-012-T	92	AC-007-002	20	AC-009-004-R	20	AC-015-004-R	20
AC-006-013	90	AC-007-002	133	AC-009-004-R	133	AC-015-004-R	133
AC-006-013-OT	92	AC-007-002-OT	22	AC-009-011	90	AC-015-012	90
AC-006-013-R	90	AC-007-002-R	20	AC-009-011-OT	92	AC-015-012-R	90
AC-006-013-T	92	AC-007-002-R	133	AC-009-011-R	90	AC-015-013-R	90
AC-006-014	90	AC-007-002-R	22	AC-009-011-T	92	AC-015-014	90
AC-006-014-OT	92	AC-007-011	90	AC-009-012	90	AC-015-014-R	90
AC-006-014-R	90	AC-007-011-OT	92	AC-009-012-OT	92	AC-015-021	104
AC-006-014-T	92	AC-007-011-R	90	AC-009-012-R	90	AC-015-202	20
AC-006-015	90	AC-007-011-T	92	AC-009-012-T	92	AC-015-202	133
AC-006-015-OT	92	AC-007-012	90	AC-009-014	90	AC-015-203	20
AC-006-015-R	90	AC-007-012-OT	92	AC-009-014-R	90	AC-015-203	133
AC-006-015-T	92	AC-007-012-R	90	AC-009-201	20	AC-015-204	20
AC-006-021	104	AC-007-012-T	92	AC-009-201	133	AC-015-204	133
AC-006-201	20	AC-007-201	20	AC-009-201-OT	23	AC-015-212	90
AC-006-201	133	AC-007-201	133	AC-009-201-T	23	AC-015-213	90
AC-006-201-OT	23	AC-007-201-OT	23	AC-009-202	20	AC-015-214	90
AC-006-201-T	23	AC-007-201-T	23	AC-009-202	133	AC-015-221	104
AC-006-202	20	AC-007-202	20	AC-009-204	20	AC-016-001	20
AC-006-202	133	AC-007-202	133	AC-009-204	133	AC-016-001	133
AC-006-202-OT	23	AC-007-202-OT	23	AC-009-211	90	AC-016-001-OT	22
AC-006-202-T	23	AC-007-202-T	23	AC-009-211-OT	93	AC-016-001-R	20
AC-006-203	20	AC-007-211	90	AC-009-211-T	93	AC-016-001-R	133
AC-006-203	133	AC-007-211-OT	93	AC-009-212	90	AC-016-001-T	22
AC-006-203-OT	23	AC-007-211-T	93	AC-009-212-OT	93	AC-016-002	20
AC-006-203-T	23	AC-007-212	90	AC-009-212-T	93	AC-016-002	133
AC-006-204	20	AC-007-212-OT	93	AC-009-214	90	AC-016-002-OT	22
AC-006-204	133	AC-007-212-T	93	AC-010-502	135	AC-016-002-R	20
AC-006-204-OT	23	AC-008-004	20	AC-010-504	135	AC-016-002-R	133
AC-006-204-T	23	AC-008-004	133	AC-010-512	135	AC-016-002-T	22
AC-006-205	20	AC-008-004-R	20	AC-010-514	135	AC-016-011	90
AC-006-205	133	AC-008-004-R	133	AC-012-001	20	AC-016-011-OT	92
AC-006-205-OT	23	AC-008-005	20	AC-012-001	133	AC-016-011-R	90
AC-006-205-T	23	AC-008-005	133	AC-012-002	20	AC-016-011-T	92
AC-006-211	90	AC-008-005-R	20	AC-012-002	133	AC-016-012	90
AC-006-211-OT	93	AC-008-005-R	133	AC-012-004	20	AC-016-012-OT	92
AC-006-211-T	93	AC-008-014	90	AC-012-004	133	AC-016-012-R	90
AC-006-212	90	AC-008-014-R	90	AC-012-011	90	AC-016-012-T	92
AC-006-212-OT	93	AC-008-015	90	AC-012-012	90	AC-016-201	20
AC-006-212-T	93	AC-008-015-R	90	AC-012-014	90	AC-016-201	133
AC-006-213	90	AC-008-204	20	AC-014-002-OT	22	AC-016-202	20
AC-006-213-OT	93	AC-008-204	133	AC-014-002-T	22	AC-016-202	133
AC-006-213-T	93	AC-008-205	20	AC-014-012-OT	92	AC-016-211	90
AC-006-214	90	AC-008-205	133	AC-014-012-T	92	AC-016-211-OT	93
AC-006-214-OT	93	AC-008-214	90	AC-014-202-OT	23	AC-016-211-T	93
AC-006-214-T	93	AC-008-215	90	AC-014-202-T	23	AC-016-212	90

Bestell-Nr. Ordering no.	Seite Page	Bestell-Nr. Ordering no.	Seite Page	Bestell-Nr. Ordering no.	Seite Page	Bestell-Nr. Ordering no.	Seite Page
AC-016-212-OT	93	AC-020-002-R	20	AC-103-215-OT	94	AD-001-001	26
AC-016-212-T	93	AC-020-002-R	133	AC-103-215-T	94	AD-001-001	96
AC-017-001	20	AC-020-004	20	AC-103-612-OT	24	AD-001-001	136
AC-017-001	133	AC-020-004	133	AC-103-612-T	24	AD-001-002	26
AC-017-001-R	20	AC-020-004-R	20	AC-103-614-OT	24	AD-001-002	96
AC-017-001-R	133	AC-020-004-R	133	AC-103-614-T	24	AD-001-002	136
AC-017-004	20	AC-020-012	90	AC-104-204-OT	24	AD-001-003	26
AC-017-004	133	AC-020-012-R	90	AC-104-204-T	24	AD-001-003	96
AC-017-004-R	20	AC-020-014	90	AC-104-205-OT	24	AD-001-003	136
AC-017-004-R	133	AC-020-014-R	90	AC-104-205-T	24	AD-001-004	26
AC-017-011	90	AC-020-202	20	AC-104-214-OT	94	AD-001-004	96
AC-017-011-R	90	AC-020-202	133	AC-104-214-T	94	AD-001-004	136
AC-017-014	90	AC-020-204	20	AC-104-215-OT	94	AD-001-005	26
AC-017-014-R	90	AC-020-204	133	AC-104-215-T	94	AD-001-005	96
AC-017-201	20	AC-020-212	90	AC-104-622-OT	94	AD-001-005	136
AC-017-201	133	AC-020-214	90	AC-104-622-T	94	AD-001-006	26
AC-017-204	20	AC-100-001	22	AC-104-624-OT	94	AD-001-006	96
AC-017-204	133	AC-100-001	23	AC-104-624-T	94	AD-001-006	136
AC-017-211	90	AC-100-001	24	AC-106-201-OT	24	AD-001-007	26
AC-017-214	90	AC-100-001	92	AC-106-201-T	24	AD-001-007	96
AC-018-001-R	21	AC-100-001	93	AC-106-202-OT	24	AD-001-007	136
AC-018-001-R	134	AC-100-001	94	AC-106-202-T	24	AD-001-008	26
AC-018-002-R	21	AC-101-201-OT	24	AC-106-203-OT	24	AD-001-008	96
AC-018-002-R	134	AC-101-201-T	24	AC-106-203-T	24	AD-001-008	136
AC-018-011-R	91	AC-101-202-OT	24	AC-106-204-OT	24	AD-001-011	26
AC-018-012-R	91	AC-101-202-T	24	AC-106-204-T	24	AD-001-011	96
AC-018-201	21	AC-101-203-OT	24	AC-106-205-OT	24	AD-001-011	136
AC-018-201	134	AC-101-203-T	24	AC-106-205-T	24	AD-001-012	26
AC-018-202	21	AC-101-204-OT	24	AC-106-211-OT	94	AD-001-012	96
AC-018-202	134	AC-101-204-T	24	AC-106-211-T	94	AD-001-012	136
AC-018-211	91	AC-101-206-OT	24	AC-106-212-OT	94	AD-001-013	26
AC-018-212	91	AC-101-206-T	24	AC-106-212-T	94	AD-001-013	96
AC-019-000-OT	22	AC-101-210-OT	94	AC-106-213-OT	94	AD-001-013	136
AC-019-000-T	22	AC-101-210-T	94	AC-106-213-T	94	AD-001-014	26
AC-019-001	20	AC-101-211-OT	94	AC-106-214-OT	94	AD-001-014	96
AC-019-001	133	AC-101-211-T	94	AC-106-214-T	94	AD-001-014	136
AC-019-001-OT	22	AC-101-212-OT	94	AC-106-215-OT	94	AD-001-015	26
AC-019-001-R	20	AC-101-212-T	94	AC-106-215-T	94	AD-001-015	96
AC-019-001-R	133	AC-101-214-OT	94	AC-107-201-OT	24	AD-001-015	136
AC-019-001-T	22	AC-101-214-T	94	AC-107-201-T	24	AD-001-016	26
AC-019-002	20	AC-101-215-OT	94	AC-107-202-OT	24	AD-001-016	96
AC-019-002	133	AC-101-215-T	94	AC-107-202-T	24	AD-001-016	136
AC-019-002-OT	22	AC-103-200-OT	24	AC-107-211-OT	94	AD-001-017	26
AC-019-002-R	20	AC-103-200-T	24	AC-107-211-T	94	AD-001-017	96
AC-019-002-R	133	AC-103-201-OT	24	AC-107-212-OT	94	AD-001-017	136
AC-019-002-T	22	AC-103-201-T	24	AC-107-212-T	94	AD-001-018	26
AC-019-011	90	AC-103-202-OT	24	AC-109-201-OT	24	AD-001-018	96
AC-019-011-R	90	AC-103-202-T	24	AC-109-201-T	24	AD-001-018	136
AC-019-012	90	AC-103-204-OT	24	AC-109-211-OT	94	AD-001-021	104
AC-019-012-R	90	AC-103-204-T	24	AC-109-211-T	94	AD-002-001	26
AC-019-021	104	AC-103-205-OT	24	AC-109-212-OT	94	AD-002-001	96
AC-019-201	20	AC-103-205-T	24	AC-109-212-T	94	AD-002-001	136
AC-019-201	133	AC-103-210-OT	94	AC-114-202-OT	24	AD-002-002	26
AC-019-202	20	AC-103-210-T	94	AC-114-202-T	24	AD-002-002	96
AC-019-202	133	AC-103-211-OT	94	AC-114-212-OT	94	AD-002-002	136
AC-019-211	90	AC-103-211-T	94	AC-114-212-T	94	AD-002-003	26
AC-019-212	90	AC-103-212-OT	94	AC-116-211-OT	94	AD-002-003	96
AC-019-221	104	AC-103-212-T	94	AC-116-211-T	94	AD-002-003	136
AC-020-002	20	AC-103-214-OT	94	AC-116-212-OT	94	AD-002-005	26
AC-020-002	133	AC-103-214-T	94	AC-116-212-T	94	AD-002-005	96

Bestell-Nr. Ordering no.	Seite Page	Bestell-Nr. Ordering no.	Seite Page	Bestell-Nr. Ordering no.	Seite Page	Bestell-Nr. Ordering no.	Seite Page
AD-002-005	136	AD-010-003	47	AD-010-022	97	AE-003-010	46
AD-002-011	26	AD-010-003	97	AD-010-022	105	AE-003-014	46
AD-002-011	96	AD-010-003	105	AD-010-022	109	AE-003-016	46
AD-002-011	136	AD-010-003	109	AD-010-022	113	AE-003-021	49
AD-002-012	26	AD-010-003	113	AD-010-022	137	AE-003-023	49
AD-002-012	96	AD-010-003	137	AD-010-023	40	AE-003-024	49
AD-002-012	136	AD-010-004	27	AD-010-023	47	AE-003-025	49
AD-002-013	26	AD-010-004	40	AD-010-024	27	AE-003-026	49
AD-002-013	96	AD-010-004	47	AD-010-024	40	AE-003-031	53
AD-002-013	136	AD-010-004	97	AD-010-024	47	AE-003-032	53
AD-002-015	26	AD-010-004	105	AD-010-024	97	AE-003-033	53
AD-002-015	96	AD-010-004	109	AD-010-024	105	AE-003-034	53
AD-002-015	136	AD-010-004	113	AD-010-024	109	AE-003-036	53
AD-002-021	104	AD-010-004	137	AD-010-024	113	AE-003-040	53
AD-003-003	26	AD-010-005	27	AD-010-024	137	AE-003-041	51
AD-003-003	96	AD-010-005	40	AD-010-031	57	AE-003-043	51
AD-003-003	136	AD-010-005	47	AD-010-034	57	AE-003-044	51
AD-003-005	26	AD-010-005	97	AE-001-001	39	AE-003-045	51
AD-003-005	96	AD-010-005	105	AE-001-002	39	AE-003-046	51
AD-003-005	136	AD-010-005	109	AE-001-003	39	AE-004-002	108
AD-003-007	26	AD-010-005	113	AE-001-004	39	AE-004-004	108
AD-003-007	96	AD-010-005	137	AE-001-005	39	AE-004-016	108
AD-003-007	136	AD-010-006	27	AE-001-006	39	AE-004-018	108
AD-003-008	26	AD-010-006	40	AE-001-007	39	AE-004-019	108
AD-003-008	96	AD-010-006	47	AE-001-008	39	AE-005-002	108
AD-003-008	136	AD-010-006	97	AE-001-009	39	AE-005-004	108
AD-003-013	26	AD-010-006	105	AE-001-010	39	AE-005-016	108
AD-003-013	96	AD-010-006	109	AE-001-011	39	AE-005-018	108
AD-003-013	136	AD-010-006	113	AE-001-012	39	AE-005-019	108
AD-003-015	26	AD-010-006	137	AE-001-013	39	AE-006-002	108
AD-003-015	96	AD-010-007	27	AE-001-014	39	AE-006-004	108
AD-003-015	136	AD-010-007	40	AE-001-015	39	AE-006-016	108
AD-003-017	26	AD-010-007	47	AE-001-016	39	AE-006-018	108
AD-003-017	96	AD-010-007	97	AE-001-017	39	AE-006-019	108
AD-003-017	136	AD-010-007	105	AE-001-030	56	AF-001-001	25
AD-003-018	26	AD-010-007	109	AE-001-031	56	AF-001-001	95
AD-003-018	96	AD-010-007	113	AE-001-032	56	AF-001-002	25
AD-003-018	136	AD-010-007	137	AE-001-033	56	AF-001-002	95
AD-004-001	138	AD-010-008	27	AE-001-034	56	AF-001-003	25
AD-004-002	138	AD-010-008	40	AE-001-035	56	AF-001-003	95
AD-004-003	138	AD-010-008	47	AE-001-036	56	AF-001-004	25
AD-004-004	138	AD-010-008	97	AE-001-037	56	AF-001-004	95
AD-010-001	27	AD-010-008	105	AE-001-038	56	AF-001-005	25
AD-010-001	40	AD-010-008	109	AE-001-039	56	AF-001-005	95
AD-010-001	47	AD-010-008	113	AE-001-040	56	AF-001-006	25
AD-010-001	97	AD-010-008	137	AE-001-041	56	AF-001-006	95
AD-010-001	105	AD-010-011	57	AE-001-042	56	AF-001-007	25
AD-010-001	109	AD-010-012	57	AE-001-043	56	AF-001-007	95
AD-010-001	113	AD-010-013	57	AE-001-044	56	AF-001-008	25
AD-010-001	137	AD-010-021	27	AE-001-045	56	AF-001-008	95
AD-010-002	27	AD-010-021	40	AE-001-046	56	AF-001-009	25
AD-010-002	40	AD-010-021	47	AE-001-047	56	AF-001-009	95
AD-010-002	47	AD-010-021	97	AE-002-001	39	AF-001-010	25
AD-010-002	97	AD-010-021	105	AE-002-002	39	AF-001-010	95
AD-010-002	105	AD-010-021	109	AE-002-003	39	AF-001-011	25
AD-010-002	109	AD-010-021	113	AE-002-006	39	AF-001-011	95
AD-010-002	113	AD-010-021	137	AE-002-007	39	AF-001-012	25
AD-010-002	137	AD-010-022	27	AE-003-001	46	AF-001-013	25
AD-010-003	27	AD-010-022	40	AE-003-003	46	AF-001-013	95
AD-010-003	40	AD-010-022	47	AE-003-004	46	AF-001-014	25

Bestell-Nr. Ordering no.	Seite Page	Bestell-Nr. Ordering no.	Seite Page	Bestell-Nr. Ordering no.	Seite Page	Bestell-Nr. Ordering no.	Seite Page
AF-001-014	95	AG-005-001	107	AH-004-001	106	AJ-003-010	114
AF-001-015	25	AG-100-006	38	AH-004-011	106	AJ-003-011	114
AF-001-015	95	AG-100-007	38	AH-005-001	106	AJ-003-012	114
AF-001-016	25	AH-001-001	33	AH-005-011	106	AJ-003-013	114
AF-001-016	95	AH-001-002	33	AI-001-001	65	AJ-003-014	114
AF-001-017	25	AH-001-011	34	AI-001-002	65	AJ-003-015	114
AF-001-017	95	AH-001-011	54	AI-001-003	65	AJ-003-016	114
AF-001-018	25	AH-001-011	63	AI-001-004	66	AJ-003-021	114
AF-001-018	95	AH-001-012	33	AI-001-005	66	AJ-003-022	114
AF-001-019	25	AH-001-013	33	AI-001-006	65	AJ-003-023	114
AF-001-019	95	AH-001-015	33	AI-001-007	68	AJ-003-024	114
AF-001-021	25	AH-001-016	33	AI-001-008	68	AJ-003-025	114
AF-001-021	95	AH-001-017	33	AI-001-009	68	AJ-003-026	114
AF-001-024	25	AH-001-018	33	AI-001-010	68	AJ-003-027	114
AF-001-024	95	AH-001-101	33	AI-001-011	68	AJ-003-028	114
AF-001-025	25	AH-001-102	33	AI-001-012	66	AJ-003-029	114
AF-002-001	26	AH-001-201	31	AI-002-001	64	AJ-003-030	114
AF-002-001	96	AH-001-202	31	AI-002-002	64	AJ-003-031	114
AF-002-001	136	AH-001-203	31	AI-003-001	110	AJ-003-032	114
AF-002-002	26	AH-001-204	31	AI-003-003	107	AJ-003-033	114
AF-002-002	96	AH-001-205	31	AI-003-003	111	AJ-003-034	114
AF-002-002	136	AH-001-211	31	AI-003-004	110	AJ-003-035	114
AF-002-003	26	AH-001-212	31	AI-003-007	112	AJ-003-036	114
AF-002-003	96	AH-001-301	32	AI-003-009	112	AJ-003-037	114
AF-002-003	136	AH-001-301	54	AI-003-010	112	AJ-003-038	114
AF-002-004	26	AH-001-301	63	AI-003-011	112	AJ-003-039	114
AF-002-004	96	AH-001-302	32	AI-004-001	110	AJ-003-040	114
AF-002-004	136	AH-001-302	54	AI-004-004	110	AJ-003-041	114
AF-002-010	26	AH-001-302	63	AI-004-007	112	AJ-003-042	114
AF-002-010	96	AH-001-303	32	AI-004-009	112	AJ-003-043	114
AF-002-010	136	AH-001-304	32	AI-004-010	112	AJ-003-044	114
AG-001-001	35	AH-001-305	32	AI-004-011	112	AJ-003-045	114
AG-001-001	67	AH-001-306	32	AI-005-001	69	AJ-003-046	114
AG-001-002	35	AH-001-308	32	AI-005-003	69	AJ-003-050	114
AG-001-002	67	AH-001-311	32	AI-005-004	69	AJ-003-051	114
AG-001-003	36	AH-001-312	32	AI-005-007	70	AJ-003-052	114
AG-001-004	36	AH-002-001	43	AI-005-008	70	AJ-003-053	114
AG-001-006	38	AH-002-011	41	AI-005-011	70	AJ-003-054	114
AG-001-007	37	AH-002-011	42	AJ-001-000	61	AJ-003-055	114
AG-001-008	37	AH-002-011	43	AJ-001-001	61	AJ-003-056	114
AG-001-009	38	AH-002-011	52	AJ-001-002	61	AJ-003-057	114
AG-001-010	70	AH-002-013	41	AJ-001-003	61	AJ-003-058	114
AG-001-011	55	AH-002-013	42	AJ-001-010	61	AJ-003-059	114
AG-001-012	55	AH-002-013	43	AJ-001-011	61	AJ-003-060	114
AG-002-001	44	AH-002-013	52	AJ-001-012	61	AJ-003-061	114
AG-002-002	44	AH-002-015	48	AJ-001-013	61	AJ-003-062	114
AG-002-003	45	AH-002-015	50	AJ-002-001	61	AJ-003-063	114
AG-002-004	45	AH-002-201	41	AJ-002-002	61	AJ-003-064	114
AG-002-007	38	AH-002-211	48	AJ-002-003	61	AJ-003-065	114
AG-002-008	38	AH-002-211	50	AJ-002-004	61	AJ-003-066	114
AG-002-010	49	AH-002-212	41	AJ-002-005	61	AJ-003-067	114
AG-002-011	53	AH-002-213	48	AJ-003-001	114	AJ-003-068	114
AG-002-012	53	AH-002-213	50	AJ-003-002	114	AJ-003-069	114
AG-002-013	51	AH-002-216	50	AJ-003-003	114	AJ-003-070	114
AG-002-014	49	AH-002-301	42	AJ-003-004	114	AJ-003-071	114
AG-002-015	51	AH-002-301	52	AJ-003-005	114	AJ-003-072	114
AG-003-001	107	AH-002-302	42	AJ-003-006	114	AJ-003-074	114
AG-003-001	111	AH-002-302	52	AJ-003-007	114	AJ-003-078	146
AG-004-001	107	AH-003-001	106	AJ-003-008	114	AJ-003-079	146
AG-004-001	111	AH-003-011	106	AJ-003-009	114	AJ-003-080	115

Bestell-Nr. Ordering no.	Seite Page	Bestell-Nr. Ordering no.	Seite Page	Bestell-Nr. Ordering no.	Seite Page	Bestell-Nr. Ordering no.	Seite Page
AJ-003-081	115	AJ-003-180	114	AM-002-007	141	AN-002-003	125
AJ-003-082	115	AJ-003-181	114	AM-002-008	141	AN-002-101	126
AJ-003-083	115	AJ-003-182	114	AM-002-010	142	AN-002-102	126
AJ-003-084	115	AJ-003-183	114	AM-002-011	142	AN-002-103	126
AJ-003-085	115	AJ-003-184	114	AM-002-012	142	AN-002-104	126
AJ-003-086	115	AJ-003-185	114	AM-002-013	142	AN-002-201	127
AJ-003-087	115	AJ-003-186	114	AM-002-014	142	AN-002-202	127
AJ-003-088	115	AJ-003-187	114	AM-002-015	142	AN-002-301	129
AJ-003-089	115	AJ-003-188	114	AM-002-016	142	AN-002-302	129
AJ-003-090	115	AJ-003-189	114	AM-002-018	142	AN-002-307	129
AJ-003-091	115	AJ-003-190	114	AM-002-020	143	AN-002-308	129
AJ-003-092	115	AJ-003-191	114	AM-002-021	143	AN-002-310	132
AJ-003-093	115	AJ-003-192	114	AM-002-022	143	AN-002-311	132
AJ-003-094	115	AJ-003-193	114	AM-002-023	143	AN-003-001	125
AJ-003-095	115	AJ-003-194	114	AM-002-024	143	AN-003-002	125
AJ-003-096	115	AJ-003-195	114	AM-002-025	143	AN-003-003	125
AJ-003-097	115	AJ-003-196	114	AM-002-026	143	AN-003-101	126
AJ-003-098	115	AJ-003-197	114	AM-002-027	143	AN-003-102	126
AJ-003-100	115	AJ-003-198	114	AM-002-028	143	AN-003-103	126
AJ-003-101	115	AJ-003-199	114	AM-002-029	143	AN-003-104	126
AJ-003-102	115	AJ-003-200	114	AM-002-030	143	AN-003-201	127
AJ-003-103	115	AJ-005-001	145	AM-002-031	143	AN-003-202	127
AJ-003-104	115	AJ-005-002	145	AM-002-032	143	AN-003-301	128
AJ-003-105	115	AJ-006-001	145	AM-002-040	149	AN-003-302	128
AJ-003-106	115	AJ-006-002	145	AM-002-041	149	AN-003-303	128
AJ-003-107	115	AJ-006-003	145	AM-003-001	146	AN-004-401	130
AJ-003-108	115	AJ-006-004	145	AM-003-002	146	AN-004-402	130
AJ-003-109	115	AJ-006-005	146	AM-004-001	143	AN-004-403	130
AJ-003-110	115	AJ-006-006	146	AM-004-002	143	AN-005-301	129
AJ-003-111	115	AJ-006-007	146	AM-004-004	143	AN-005-302	129
AJ-003-112	115	AJ-006-008	146	AM-004-006	143	AN-005-303	129
AJ-003-113	115	AJ-006-012	116	AM-005-001	144	AN-005-304	129
AJ-003-114	115	AJ-006-012	146	AM-005-002	144	AO-001-001	150
AJ-003-115	115	AJ-010-006	39	AM-005-003	144	AO-001-002	150
AJ-003-116	115	AJ-010-006	46	AM-005-004	144	AO-001-003	150
AJ-003-117	115	AJ-010-006	49	AM-006-000	147	AO-001-005	150
AJ-003-118	115	AJ-010-006	51	AM-006-001	147	AO-001-007	150
AJ-003-120	115	AJ-010-006	57	AM-006-002	147	AO-001-008	150
AJ-003-121	115	AJ-010-006	68	AM-006-003	147	AO-001-009	150
AJ-003-122	115	AJ-010-006	70	AM-006-011	147	CG-001-001	159
AJ-003-123	115	AJ-010-006	108	AM-006-012	147	CG-001-002	159
AJ-003-124	115	AJ-010-006	112	AM-006-013	147	CJ-005-020	160
AJ-003-125	115	AJ-010-011	116	AM-006-021	147	CJ-005-022	160
AJ-003-126	115	AJ-010-012	116	AM-006-022	147	CJ-005-023	160
AJ-003-127	115	AJ-010-013	116	AM-006-023	147	CJ-005-025	160
AJ-003-128	115	AJ-010-015	71	AM-006-031	147	CJ-005-026	160
AJ-003-140	116	AJ-010-015	73	AM-006-032	147	ED-030-001	148
AJ-003-141	116	AJ-010-018	116	AM-006-033	147	ED-030-002	148
AJ-003-142	116	AJ-010-020	60	AN-001-001	125	ED-030-003	148
AJ-003-143	116	AJ-010-021	60	AN-001-003	125	ED-030-004	148
AJ-003-170	114	AM-001-001	140	AN-001-101	126	ED-030-005	148
AJ-003-171	114	AM-001-002	140	AN-001-102	126	ED-030-006	148
AJ-003-172	114	AM-001-003	140	AN-001-103	126	ED-030-007	148
AJ-003-173	114	AM-001-004	140	AN-001-104	126	ED-030-008	148
AJ-003-174	114	AM-002-001	141	AN-001-301	129	ED-030-009	148
AJ-003-175	114	AM-002-002	141	AN-001-302	129	ED-030-010	148
AJ-003-176	114	AM-002-003	141	AN-001-310	131	ED-030-011	148
AJ-003-177	114	AM-002-004	141	AN-001-311	131	EI-003-001	151
AJ-003-178	114	AM-002-005	141	AN-002-001	125	EI-003-003	151
AJ-003-179	114	AM-002-006	141	AN-002-002	125	EJ-030-001	119

Bestell-Nr. Ordering no.	Seite Page
EJ-030-002	119
EJ-030-003	119
EJ-030-010	119
EJ-030-031	119
EJ-030-032	119
EK-010-010	139
EK-010-011	139
EK-010-012	139
EK-010-013	139
EK-010-014	139
EK-010-015	139
EK-010-016	139
EK-010-017	139
FA-001-001	118
FA-001-001-G	118
FA-001-001-R	118
FA-002-001	118
FA-002-001-G	118
FA-002-001-R	118
FA-010-001	117
FA-010-002	117
FA-010-003	117
FA-010-004	117
FA-010-005	117
FA-010-006	117
FA-020-001	118
FA-020-010	118
FA-020-011	118
GB-005-014	151



Lined writing area with alternating light blue and white horizontal bands.





Large area with horizontal lines for writing notes.

Lined area for notes, consisting of alternating light blue and white horizontal bands.



STEMA Medizintechnik GmbH
take-off GewerbePark 74
78579 Neuhausen ob Eck - Germany

Phone: 0049 (0) 74 67 / 79 63 00
Fax: 0049 (0) 74 67 / 79 63 06 9

info@stema-medizintechnik.de
www.stema-medizintechnik.de